

Welcome!

Since 1979, EURO TOOL has become a trusted name when looking for quality, innovative products in the jewelry arts trade. As one of the largest master distributors to the jewelry, hobby and craft trades, we proudly bring you the most extensive selection of quality merchandise at the most competitive prices in the industry.

There is something for everyone in this new issue. Please take time to browse the wide selection of specialty items including a newly expanded metal clay section, testing, bead stringing, metal forming and much more.

Whether you are a new EURO TOOL distributor or have been a loyal member of our 'team', we promise you will not be disappointed. Take a look at our impressive selection and enjoy our unparalleled customer service.

We appreciate being part of your business.

Sincerely,

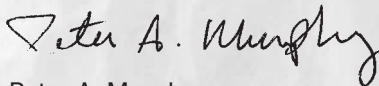

Peter A. Murphy
President

*"We are what we repeatedly do.
Excellence then, is not an act, but a habit."
— Aristotle*

Our Mission

EURO TOOL is genuinely committed to the success of our customers.

Our Philosophy

Maintain a high level of integrity and honesty in every aspect of our business. Anticipate the needs of our customers. Innovate.

Jewelry on cover designed by Genevieve Flynn

TABLE OF CONTENTS

2	Bead Stringing
28	Bench Tools
38	Brushes/ Buffs
42	Burs
49	Carving
52	Casting
59	Cleaning
66	Diamond Coated Instruments
70	Diamond and Stone Setting
79	Drills
82	Files
88	Gauges
96	GRS Products
98	Glues/ Adhesives
100	Hammers
103	Knives
105	Metal Forming – Drawplates/ Mills
106	Metal Forming – Punches
109	Metal Forming – Dapping
112	Metal Forming – Mandrels
114	Optical
122	Organizers/Storage
129	Pliers and Cutters
165	Plating
166	Polishing
175	Precious Metal Clay Tools/Supplies
180	Publications
183	Ring Stretchers/ Ring Clamps
186	Sawblades/ Sawframes
189	Scales
191	Screwdrivers
195	Shears/ Scissors
197	Soldering
208	Testing Supplies
211	Tweezers
221	Watchmaking
238	Wire/ Sheet
239	Stock Number Index
244	Product Index



This symbol is placed by products that have been added to our line to help you easily identify what's new in the EURO TOOL catalog.



Indicates those products which are only available from EURO TOOL or one of our authorized distributors.



Products that have been engineered and developed by EURO TOOL.



Indicates products Made in USA.

Prices shown are subject to change without notice due to fluctuation in foreign exchange rates, raw material costs, duties and other factors beyond our control.

Please note: All products herein are not toys and therefore are not for use by children.

EURO CRIMPERS – Bead Crimping Pliers



A



B



C



D

The revolutionary tool brought to you by EURO TOOL is now offered in four styles – all designed specifically for various size crimps, crimp covers and even crimp ends. With the patented design of our crimpers you will get smooth rounded crimps, rather than flattened crimps with sharp or pointed edges as you do using conventional pliers. The PVC handles are designed for maximum comfort and leverage. All three sizes are made of high grade steel, with non-glare black oxide finish, and the jaws are precision ground to assure perfect crimps for years. For best results only high quality crimps should be used. Each of the pliers comes with complete instructions. Patents: D356,520; 5,426,843; DES. 366,199.

- A. **Original Bead Crimper** for beads from 2 to 3 mm which works with either tube crimps or round crimps. We recommend that you use round (spherical) crimps if the crimp is going to be hidden, as they hold better than tube crimps. Tube crimps are more attractive when they are to be seen.
- B. **The Mighty Crimper** was developed for larger beads of 3mm diameter, and is exceptionally handy for closing crimp ends, eyelet ends, cap end, pinch clasps and crimp covers. Because of the rounded jaws, it will leave no marks or flat spots. Because of its larger size, the Mighty Crimper is made of slightly thicker steel, giving it 2.2mm wide jaws which are precision milled.
- C. The **Micro Crimper** is also an adaptation of the Original Crimper, to be used with 1mm size crimps. It too has precision ground jaws, which are slightly thinner for the smaller crimps which have become popular with the introduction of finer wire.
- D. Now you can crimp any crimp bead of “medium” size (2mm – 3mm) and various shapes – quick and easy! The **Dual EuroCrimper™** has two forming cavities for round, tube and combination crimps of slightly varying sizes. But wait...the new, true ergonomic handles give you a great grip, too, because they are made from sanoprene – a special compound – with excellent surface tack. Like our other patented crimpers, **Dual EuroCrimper™** jaws are precision machined for years of service and beautiful results every time.

Stock #	Description	Length	
A. PLR-585.00	Original Bead Crimper	5" (125mm)	\$13.45
B. PLR-584.00	Mighty Crimper	5 1/4" (135mm)	\$14.95
C. PLR-586.00	Micro Crimper	5" (125mm)	\$13.45
D. PLR-582.00	Dual EuroCrimper	5 3/4" (145mm)	\$16.95

How to Form the Perfect Crimp

At the last bead (A), pass the jewelry wire (B) through the crimp bead or tube (C) then through the clasp or jump ring (D) - back through the crimp (C) - and optionally back through the end bead (A).

Step 1 - secure the crimp in the crimping station (E). Best results are obtained when the two wires are positioned on either side of the center dimple.

Step 2 - final shaping in the rounding station (F) - forming a smooth, rounded crimp.

NOTE: When bead stringing it is important for the bead crimp to match whatever wire that one is using. The worst case is using too large of crimp with finer wire, then the crimp may not close enough to hold properly. Always test that the crimp is secure on the wire.

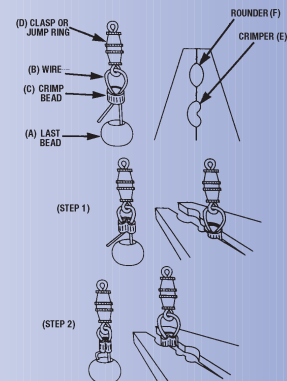

Visit our website to see the bead crimping instructional video at www.eurotool.com

SUPERIOR BEADER'S TOOL KIT

The Superior Beader's Tool Kit from EURO TOOL offers all the essential tools for beading or wire working. In a compact, leatherette case, this set is perfect for the artist on the go! The following items are included in our lightweight, compact tool kit:

- Original Bead Crimping Pliers
- Knot Cutter
- Nylon Jaw Pliers
- #5 Knotting Tweezers
- Wire Rounder
- Split Ring Tweezers
- Chain Nose Pliers
- Round Nose Pliers
- Sidecutter

Stock #
KIT-405.09

\$59.95



Kits are a Hit!

**BASIC BEADING KIT**

Our beading kit contains the essential tools and supplies for the beginning beader, including all basic pliers, tools, design board and instruction book. Customized kits also available. Kit includes:

- Chain Nose Plier
- Round Nose Plier
- Sidecutter
- #5 Beading Tweezer
- Basic Beading Instruction Book
- 80mm Brass Gauge
- Bead Board
- Beading Awl
- Thread Scissors

Stock #
BDK-110.00

\$35.95

**PROFESSIONAL PEARL/BEAD STRINGING KIT**

Professional Pearl/Bead Stringing Kit includes an instructional DVD. This extensive kit includes items specifically needed for stringing and knotting for the experienced and professional level. The following tools and supplies come with a durable canvas tote:

- Original Bead crimping pliers
- Flocked bead board
- Italian flush cutters
- Knotting tool w/ instructional DVD
- Deluxe bead reamer set
- Silk thread assortment
- 100 Sterling silver crimps
- Stringing Instruction book
- Chain nose pliers
- Flat nose pliers
- Round nose pliers
- Pearl/bead tweezers
- Container organizer
- Beeswax
- Carrying tote
- Thread scissors
- Brass mm gauge
- Stringing needles
- Jeweler's Cement

Stock #
KIT-421.00

\$99.95

**ADVANCED WIRE WRAPPING TOOL KIT**

Everything needed for the beginner to advanced wire wrapper. Every item is first quality. This kit includes the following:

- Wire Gauge
- Steel Ring Mandrel
- Pin Vise
- File cut 2
- Ruler
- Rawhide Mallet
- Head Magnifier
- Brass Gauge
- Wire Wrap Mandrels
- "Moods in Wire"
- Cutter
- Bent nose pliers
- Chain nose pliers
- Round nose pliers

Stock #
KIT-500.00

\$119.95

**BASIC WIRE WRAPPING KIT**

Excellent companion to our wire wrapping books. Everything you need to get started. Also makes a great gift combined with any of our wire wrapping books. Kit includes:

- Round nose lap-joint pliers
- Chain nose lap-joint pliers
- Flat nose lap-joint pliers
- Sidecutter
- Rawhide Mallet
- Pin Vise w/ four collets
- Equaling needle file
- Aluminum ring mandrel
- Steel ruler
- Steel scribe
- Brass gauge

Stock #
WRK-100.00

\$59.95

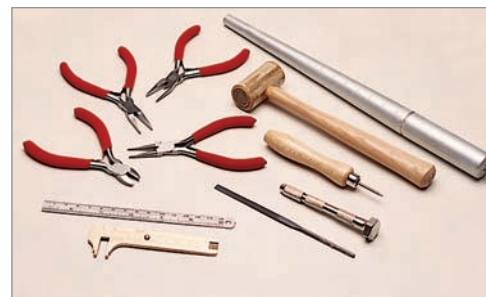



Open and close jump rings using a chain nose plier and our linking ring.

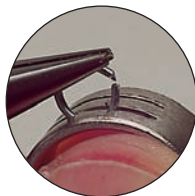

MISTER TWISTER

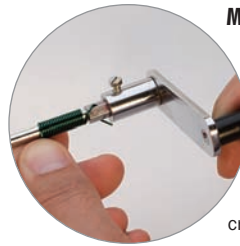

New from EURO TOOL, you need to meet Mister Twister. If you are doing small projects, this is the best way to make jump rings and coils economical. Mister Twister is a slick little device with a rotating handle that attaches to our coiling mandrels. Just thread the wire through the small hole, rotate the crank while holding the wire in place and you will have all the jump rings or coils you need for those small jobs.

Stock #	Description	Mandrel Sizes	
WIR-120.00	Mister Twister w/ 8 Standard Mandrels	1, 2, 2.5, 3, 4, 5, 6, 8mm	\$32.95
A. WIR-120.05	Set w/ 8 – 6" Long Mandrels	1, 2, 2.5, 3, 4, 5, 6, 8mm	\$34.95
B. WIR-120.10	Set w/ 6 – 6" Oval Mandrels	2, 2.5, 3, 4, 5, 6mm	\$33.95

QUICK COILER SETS



Stop that laborious cranking and try our Quick Coiler exclusively from EURO TOOL. Create colorful and sophisticated designs using the combination of mandrels available. Each Quick Coiler set includes our battery powered drill, Mister Twister Coiler, plus coiling mandrels. Each mandrel has the universal hexagonal fitting to accommodate any battery powered screwdriver or drill with low speed setting.

Stock #	Description	Mandrel Sizes	
WIR-100.00	Set w/ 8 Standard Mandrels	1, 2, 2.5, 3, 4, 5, 6, 8mm	\$59.95
C. WIR-100.05	Set w/ 8 – 6" Long Mandrels	1, 2, 2.5, 3, 4, 5, 6, 8mm	\$63.00
WIR-100.10	Set w/ 6 – 6" Oval Mandrels	2, 2.5, 3, 4, 5, 6mm	\$62.00

JUMP RING COILER SET

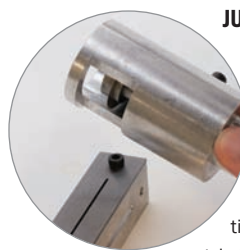

The combination of our Quick Coiler with coiling mandrels and the Jump Ringer Cutting system allows you to make hundreds of jump rings in just minutes. Easy and safe to use. Simply coil the wire on the mandrel using the power coiling drill. Then insert the coil in the coil holder. Use the included cutting attachment and blade with your flex shaft (#30 style handpiece recommended) to cut precision jump rings

in the wire and color of your choice. Kit includes drill, eight 6" long mandrels in sizes 1, 2, 2.5, 3, 4, 5, 6, and 8mm, 6" coil holder, and cutting attachment with blade and blade arbor.

Stock #	Description	
D. JMP-152.00	Jump Ring Coiler Set	\$255.00
JMP-150.10	Coil Cutter and Holder Only	\$215.25
JMP-150.50	Sawblade Only	\$10.95

COIL HOLDING/CUTTING KIT

Our deluxe coiling kit includes everything needed to make and cut coils for use in jewelry arts or as jump rings. This kit includes our Quick Coiler set with 8 standard coiling mandrels (size 1, 2, 2.5, 3, 4, 5, 6, 8mm), our coil holding pliers to securely hold the coil when cutting, and a quality 3" sawframe and 1 dozen blades for cutting the coil into rings. Also included is a 2oz tube of Cut Lube for lubricating the sawblades for a cleaner, easier cut.

Stock #	Length	
E. KIT-450.00	Coil Holding/Cutting Kit	\$89.95

LINKING RING

Our linking rings are extra handy for opening and closing jump rings of various sizes. With a chain nose plier and our linking ring, one can open and close jump rings with ease and accuracy, without damaging other parts on necklaces, earrings, etc. Linking rings are stainless steel and have three different size grooves to fit various jump rings.

Stock #		
F. HOL-169.00		\$2.95

DELUXE THREE PIECE DIAMOND BEAD REAMER SET

The Diamond Bead Reamer Set, exclusively from EURO TOOL features three points and a 4½" hollow handle in which to store them. This state-of-the-art tool has been re-engineered. You'll find the Diamond Bead Reamer set to be more versatile, easier to use and trouble free. Made in USA. Features include:

- Three diamond tips: small and large reaming tips plus 45° edge reamer. Also available separately a steel cone reamer for metal beads.
- Easy release chuck friction fitted into the aluminum housing which releases instantly when the collet is unscrewed.
- Anodized aluminum handle; brass chuck so rust is never a problem.

Stock #	Description	
A. DIB-274.00	Three Piece Set w/ Comfort Grip Handle	\$15.95
B. DIB-275.00	Three Piece Set	\$14.95

Replacement Reamers

Stock #	Description	
DIB-275.01	Three Piece Tip Set (Includes C-E)	\$5.95
DIB-275.02	Four Piece Tip Set (Includes C-F)	\$6.95
C. DIB-275.55	Large Diamond Reamer	\$2.45
D. DIB-275.05	Small Diamond Reamer	\$1.85
E. DIB-275.50	45° Diamond Edging Point	\$1.65
F. DIB-275.40	Steel Cone Bur Reamer for Metal Beads	\$1.65

CORDLESS BEAD REAMER

The cordless bead reamer is a great tool to smooth and enlarge bead holes. Light weight and easy to use, it comes with 3 tips, small pointed, 45° edger and large pointed reamer. With a comfortable molded handle, and at 10,000 RPM's, bead reaming is made easy. This unit is powered by 2 AA batteries (not included). Packaged retail ready in a clear, compact hang-up blister and card. Always wear safety glasses when using this tool.

Stock #	
G. HDP-380.00	\$11.95

MOTORIZED BEAD REAMER

A revolutionary tool for the beading industry. Motorized Bead Reamer with chuck accommodates 1/8" shank diamond points. With a motor which goes to 15,500 RPM, the speed is adjustable by a switch on the AC adapter. The body of this handpiece is lightweight and only 1½" in diameter making it comfortable to hold while working. Includes three diamond points: Small Point (DIB-275.05), 45° Edger (DIB-275.50) and Large Diamond Reamer (DIB-275.55).

Stock #	Description	
H. HDP-375.00	Motorized Bead Reamer Set	\$39.95
HDP-375.50	Handpiece Only	\$35.95

DIAMOND-COATED BEAD REAMER SET

Our handy bead reamer set is an excellent tool for bead stringers and a great addition to any toolbox. One diamond instrument is long and sharp for reaming bead holes. The other is a 45° point for rounding off the edges of holes so that they do not cut through bead cord. Both are set securely in hardwood handles. The separate components are also available individually.

Stock #	Description	Length	
I. DIB-270.01	Bead Reamer Set (2 pc)		\$8.95
DIB-261.05	Reaming Point w/ Handle	4½"	\$4.45
DIB-271.50	45° Edging Point w/ Handle	4½"	\$4.45

REAMER SET/WAX "DETAILER"

Phenomenal tools for filing and shaping wax, but also exceptional bead or pearl reaming tools. Our detailers are extremely small to work in tight places and enlarge small holes where necessary. The points have file-like edges to cut smoothly and quickly. Stainless steel tips will not rust. This set features fine and very fine reamers (0.6mm and 1.0mm diameters) with comfortable wood handles. Each is packaged in a clear protective tube. Total length 5", handle length 4" and handle diameter 3/8". Another EURO TOOL exclusive. Made in USA.

Stock #	Description	Length	
J. CVR-505.15	Set of 2		\$10.25
CVR-505.05	Reamer - Very Fine (0.6mm)	5"	\$5.15
CVR-505.10	Reamer - Fine (1.0mm)	5"	\$5.15

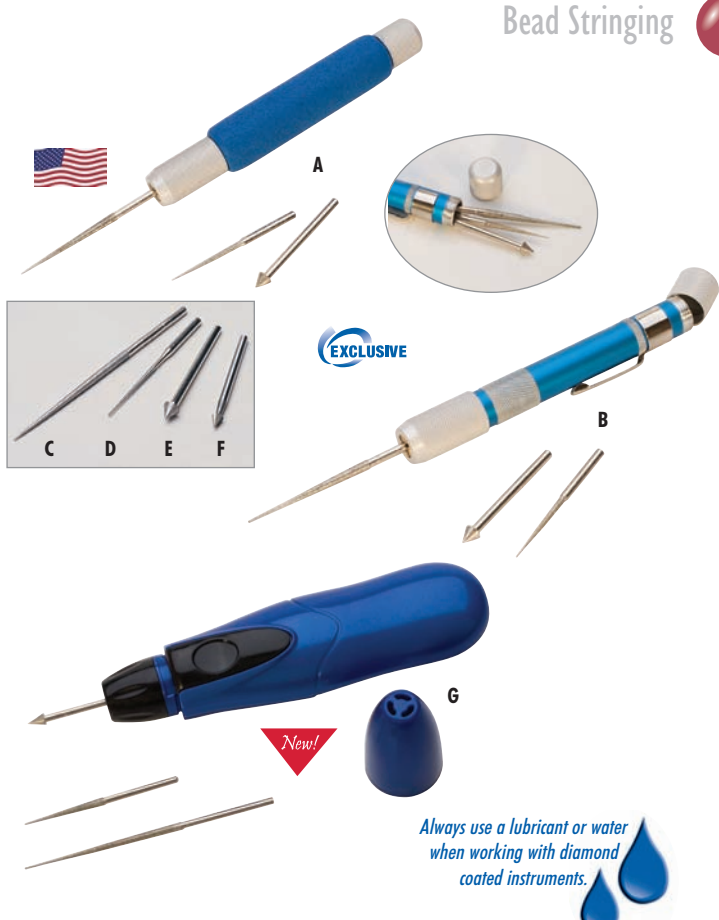

EXCLUSIVE

New!

Always use a lubricant or water when working with diamond coated instruments.

File-like edges cut smoothly and quickly!

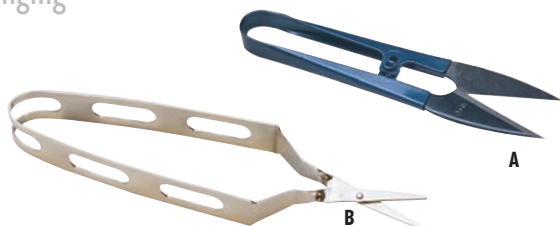

A



B



C



D



F



G



I



J

MICRO SNIP

Perfect for cutting bead cord or thread snipping. Well-tempered with very sharp edges. Reflex action makes light work fast and easy.

Stock #	Length	
A. SHR-210.00	3 1/2"	\$2.95

SQUIZZERS

Revolutionary scissors have a more acute shearing angle to cut cleaner and smoother than regular scissors. With surgical-grade series 300 stainless "spring steel", Squizzers will last longer and will not rust or corrode. Blades are 5/8" and slightly rounded for safety. Consistent cutting at the tip as one blade is lightly serrated to hold thread or cord eliminating slippage. Easier to use with no clumsy loops. Perfect for right or left handed users.

Stock #	Description	Length	
B. SCI-520.00	Straight, Serrated	4 3/4"	\$12.95
C. SCI-525.00	Curved, Serrated	4 3/4"	\$15.95

PRECISION SCISSORS

The perfect pair of scissors for all beading and other delicate work. With large comfortable handles, the small pointed blades are made of high-impact stainless steel and held securely together for smooth cutting and extended life. The overall light feel of these scissors lessens fatigue. Our precision scissors are the very best you'll find.

Stock #	Length	Blade Length	
D. SCI-101.00	3 5/8"	3/4"	\$9.95
SCI-105.00	4"	1 1/4"	\$9.95
SCI-110.00	4 3/4"	1 1/2"	\$10.95

BIRD SCISSORS

They've been around for years, but people seem to love the stylish, impulsive look of "Bird Scissors" and they work well for bead stringing and other small projects. Stainless steel, crisp and sharp!

Stock #	
E. SCI-104.00	\$5.95

LINDSTROM MULTIPURPOSE SHEAR

With ergonomic, cushion grip handles and blades with a 57-59 Rockwell hardness for long life, our Lindstrom shear easily cuts through 28 gauge silver stock. For precise cuts, this shear is simply unbeatable.

Stock #	Length	
F. SHR-600.00	5 3/4" (145mm)	\$33.95

BEAD NIPPERS

Two full flush bead nippers offer you the choice of our well known SHR-170.00 or the new version, SHR-175.00 with a more ergonomic handle. Both feature the desired "shear action" cut so the edges hold up longer and give you a truly "flush" cut. Excellent for all soft wire up to 20 gauge and beading wire too!

Stock #	Description	Length	
G. SHR-170.00	Regular	5" (125mm)	\$6.15
H. SHR-175.00	Traditional Ergonomic	5" (125mm)	\$5.10

Great Value!

PERFECT END THREAD BURNER

End the fray! Why didn't someone think of this before? The original BeadSmart Thread Burner by EURO TOOL is perfect for stopping frayed ends of thread on embellishments, peyote stitch, or anywhere raw ends need to be eliminated. Cuts and cauterizes! Fact is that the tip heats to red hot at the touch of a button and melts synthetic threads so that they don't unravel. Powered by one AA battery (included). The Perfect End Thread Burner is reasonably priced and the ultimate tool for bead stringers. Replacement tip also available.

Stock #	Description	
I. PEN-510.00	Perfect End Thread Burner	\$24.95
J. PEN-500.01	Replacement Tip	\$5.95

FLUSH or SEMI-FLUSH PRECISION SIDECUTTERS

This cutter, made in Europe, offers the perfect answer to crafts people who need strength in a precision sidecutter. Jaws pass one another ever so slightly and therefore do not dull as quickly as conventional cutters. With a smooth spring return and ergonomic cushion grip handles.

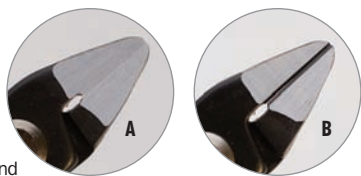

Stock #	Description	Length	
A. PLR-470.00	Ultra Flush	5" (125mm)	\$25.33
B. PLR-470.10	Semi-Flush	5" (125mm)	\$25.87

C.H.P. MILANO ITALIAN FLUSH CUTTER

New Italian cutter, made of high grade tool steel is perfect for lighter jobs were a flush cut is essential. This cutter, made in Italy features a blackened non-glare head, return spring and high friction ergonomic grips. Maximum cut is 16 gauge 1.5mm copper wire.

Stock #	Length	
C. PLR-487.00	5 1/2" (140mm)	\$10.95

FULL FLUSH CUTTER

Specifically designed for multi-strand beading wire, this cutter is full-flush with jaws induction hardened to 60-62 Rockwell. Used properly this degree of hardness assures a clean cut, time after time. Cutting edges are precisely aligned and the black oxide non-glare head has "relieved" design for reaching into tight areas. This quality German cutter also features double-leaf springs and yellow PVC handles. Use on flexible beading wire and soft wire only up to 18 gauge. Made in Germany.



Stock #	Description	Length	
D. PLR-477.00	Flush Cutter	4 1/2" (115mm)	\$26.95
E. PLR-477.50	Flush Cutter, Pointed Jaw	4 1/2" (115mm)	\$27.75

FLUSH CUT WIRE CUTTERS

Xuron cutters made in the U.S. specifically for precision applications. For wire or heavy metal strands where you don't want to ruin your normal cutters.

- Return springs and ergonomic handles.
- Available with beveled or straight jaws.
- Shear action gives a smooth flush cut on both sides.
- 90° cutting edges dull less than conventional cutters.

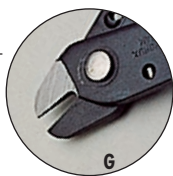

Stock #	Description	Length	
F. PLR-469.10	Straight Jaw	4 3/4" (120mm)	\$16.45
G. PLR-469.11	Thin (Beveled) Jaw	4 3/4" (120mm)	\$19.45

MEMORY WIRE CUTTERS

To save time and avoid waste, we have created a cutter for ring shanks 2.5mm or less. With one jaw flat, and the other curved to conform to most rings, this cutter will give the user a clean, right angle cut so both sides can be easily rejoined. Sweeping up gold or silver filings will not be necessary.

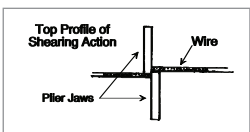

Stock #	Description	Length	
H. PLR-461.00	Hard Wire Shear Cutter	5 1/2" (140mm)	\$19.85
I. PLR-461.50	Hard Wire Shear Cutter - Economy	5 1/2" (140mm)	\$13.75

CARBIDE JAW/MEMORY WIRE CUTTERS

Carbide cutters are made particularly for hard wire and feature carbide jaw inserts for maximum hardness. Made in the same method as cutters used by orthodontist for hard wire, cutters feature PVC cushion grip handles on the large plier, velvet PVC on the small plier and gentle return springs on both. You can get years of service from this tool, which is almost indestructible when used properly. Maximum cut 12 ga.



Stock #	Description	Length	
J. PLR-781.00	Carbide Cutter	5 1/2" (140mm)	\$26.95
PLR-781.50	Small Carbide Cutter	4 1/4" (110mm)	\$21.95

Ideal cutter for multi-strand beading wires.



Relieved head design is great for reaching into tight areas.



Carbide Jaws!





MULTI-LOOPING PLIERS

Why have three separate bail making pliers when you can have one that does the job of three? Our Multi-Looping Pliers can make a variety of loops ranging from 2mm to 9mm for a variety of combinations. Made of stainless steel with double leaf springs, these pliers are another first – invented by EURO TOOL.

Stock #	Description	Length	
A. PLR-736.00	Multi-Looping Pliers	6" (150mm)	\$16.95

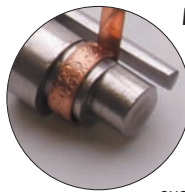

MULTI-SIZE WRAP 'N' TAP PLIERS

Our newest Wrap 'n' Tap Pliers offer the user greater versatility. With two sizes available you can shape rings as well as make loops in many sizes. Pliers are especially good for looping stock that has a pattern, or hollow stock. 6 1/2" (165mm) in length, the Multi-size Wrap 'n' Tap pliers feature cushion grips and are made of stainless steel.

Stock #	Description	Length	
B. PLR-746.02	5, 7, 10mm Barrel	6 1/2" (165mm)	\$28.95
C. PLR-746.03	13, 16, 20mm Barrel	6 1/2" (165mm)	\$28.95

MASTER COILER

Our "Master Coiler" is the painless plier. It is developed to make loops and coils without nicking precious wire which can cause a great deal of psychological pain to the user – not to mention what it does to the wire. Normal concave/convex pliers nick, but the "Master Coiler" allows one to hold the wire with the flat jaw while rotating the round jaw to form the perfect loop! Comfort grips, non-rust highly polished stainless steel jaws and standard step-jaw for consistent loops and coils.

Stock #	Length	
D. PLR-747.00	5 3/4" (145mm)	\$11.95

WIRE LOOPING PLIERS

Stainless steel wire looping pliers, also known by model train enthusiasts as coupling pliers, enable the user to bend wire easily. Three round jaws in one and box-jointed for durability. Jaws are finely polished, one being round and the other concave.

Stock #	Length	
E. PLR-748.00	5 3/4" (145mm)	\$11.95

GROOVY LOOPING PLIERS by WOLF TOOLS®

The Groovy Looping Pliers, designed by Kate Wolf, enable the user to repeat three exact sizes of loops when wire wrapping, making earring loops or similar tasks. The round jaw is smooth with a nice taper. The flat jaw tapers to the point so that the user can see exactly what she is doing during fabrication. Made of stainless steel and box-jointed with dual leaf springs. Also available without grooves for a more traditional, yet improved looping plier.

Stock #	Description	Length	
F. PLR-751.00	Wolf Groovy Looping Pliers	5" (125mm)	\$16.95
G. PLR-753.00	Wolf Looping Pliers (no grooves)	5" (125mm)	\$15.95



GROOVY CHAIN NOSE PLIERS by WOLF TOOLS®

Kate Wolf has solved the problem of making nice right angle bends in wire by creating what she calls the "Groovy Chain Nose Pliers." One side of the jaw is perfectly straight and the groove aligns the wire at a perfect 90° angle every time. Groovy pliers can also be used to bend flat pieces at a nice right angle as well, because you will "see" the right angle. Made of stainless steel, pliers feature ergo handles with PVC grips, dual leaf springs, and box joint construction.

Stock #	Description	Length	
H. PLR-752.00	Wolf™ Groovy Chain Nose Pliers	5 3/4" (145mm)	\$16.95

BEADER'S DELIGHT PLIERS

This unique plier, developed by EURO TOOL is an essential for bead stringers and wire wrappers because it is a multi-task tool. It offers a round nose for coiling wire, a flat jaw for flattening, straightening or bending at right angles, a groove for closing coils or jump rings and a sidecutter. Made of stainless steel with a gentle coil return spring and cushion grip handles for comfort.

Stock #	Length	
A. PLR-577.00	4¾" (120mm)	\$12.95

FOUR-IN-ONE BEADER'S DELIGHT

Developed by EURO TOOL, this plier is our Four-in-One "Beader's Delight." A must for wire wrappers too because it offers a finely tapered long nose for coiling, a flat jaw for flattening, straightening or bending, a groove for closing coils and jump rings, plus sidecutter. Great for travel with PVC grips, double-leaf springs. Total length 5" (130mm).

Stock #	Length	
B. PLR-577.10	5" (125mm)	\$9.95

BEAD KNOTTING PLIERS

This ultra-light plier gives the user precise surgeon-like control with a slim size of 3/16" x 1/8" at hinge pin. Box-joint construction, stainless steel and curved, comfort-designed cushioned handle give the Bead Knotting Plier an appeal that's hard to resist.

Stock #	Length	
C. PLR-580.60	5¼" (135mm)	\$6.95

KNOTTER TOOL

Produce a tight, consistent knot every time with this premium Knotter Tool. It may be used in the left or right hand to yield professional looking results. Works wonderfully with pearls and crystals strung on silk or poly thread. The Knotter Tool does the work of both a beading awl and tweezers, so creating knots is easy and fun! Our Pro Knotter tool has a smooth wood handle. Our economy Bead Knotting Tool is made of durable plastic with quality metal components.

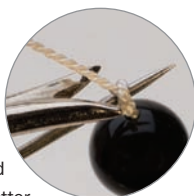

Stock #	Description	
D. BDK-400.00	Pro Knotter Tool	\$24.99
E. BDK-410.00	Economy Knotter Tool	\$14.95

BEADING KNOTTING/UTILITY TWEEZERS

The No. 1 shape tweezer and the bead stringing tweezer No. 5 are economical and well-finished in stainless steel.

Stock #	Style	Length	
F. TWZ-735.10	No. 1	4¾" (120mm)	\$1.80
G. TWZ-735.22	No. 5	4½" (115mm)	\$2.80

BEADING AWLS

High quality, traditional beading awl made of stainless steel with fine tapered point. Comfortable round handle with sure-hold knurling.

Stock #	Length	
H. CVR-400.30	6" (150mm)	\$2.65

This bead stringing awl has a hardwood handle and fine point for bead knotting or cleaning out bead holes.

Stock #	Length	
I. SPK-925.00	6¼" (160mm)	\$2.45

Handy awl made more usable by adding a comfortable PVC handle. Great for knotting cord, picking and probing. Stainless steel with fine point.

Stock #	Length	
J. PIK-400.35	5¾" (145mm)	\$3.45



A

EURO TOOL®
original

B

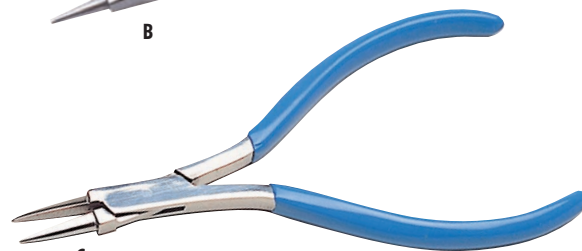

C



D



E

New!

See our instructional video at
www.eurotool.com

F



G



H



I



J



Wire Rounder easily takes away rough edges off the ends of wire.

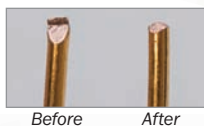

EXCLUSIVE



Other drawplates shown on page 105.



"Wonderful Wearable Wire" is a complete instruction and design book for using your WigJig. See page 180.



EURO JUMP RING PLIERS

Why use bulky, awkward pliers for placing and closing jump rings when you can use this improved model? Because the jaws come to a point and are nicely grooved, you can close jump rings without scratching the ring itself. This plier also allows the user to get into tight places and hold the jump ring for soldering.

Stock #	Length	
A. PLR-260.55	4 1/2" (115mm)	\$11.95



SPLIT RING PLIERS

A EURO TOOL original invention, this is a much needed tool which opens split rings easily. Just put the tooth jaw between the overlapping split ring and squeeze. The split ring pops open, ready for the user to put onto chains, etc.

Stock #	Description	Length	
B. PLR-589.00	Traditional Coated Handles	5 1/4" (135mm)	\$7.95
C. PLR-588.00	Ergonomic Grips	5 1/2" (140mm)	\$8.45

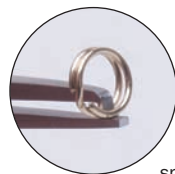

SPLIT RING TWEEZER

Another EURO TOOL original. An easy-to-use stainless steel tweezer for opening small to medium split rings. Just put the split ring under the claw and squeeze. It's simple and fast.

Stock #	Length	
D. TWZ-608.00	4 1/2" (115mm)	\$5.95

WIRE ROUNDER

The one and only tool to effectively de-bur the end of a wire after it has been cut! This 1.8mm cup bur does the job with a couple of twists of the hardwood handle. Simple and economical. A must for everyone.

Stock #		
E. BUR-261.80		\$5.99



WIRE ROUNDER SET

This set includes our new PIN-224.00 Wood Top Pin Vise and two cup burs. One bur has an inside diameter of 1.2mm and the other is 1.8mm. The pin vise has a comfortable round wood top.

Stock #		
F. PIN-225.05		\$9.95

ROSEWOOD DRAWPLATE

This handy tool is designed for reducing soft chain or woven chain. Made of hard boxwood with 12 smooth holes, the user simply pulls the material through consecutively smaller holes reducing the size of the chain. Note that on one side of the block the holes are slightly chamfered to facilitate pulling the wire through. User may put the "tang" of the block into a vise or hold it by hand.

Stock #	Dimensions	Hole Sizes	
G. DRA-120.00	3 1/2" x 2 1/2" x 3/4"	1.2mm - 6.5mm	\$10.95

OLYMPUS WIGJIG™ TRANSPARENT JIG

This transparent jig has 481 holes and 40 pegs in two sizes, instructions and wire working tips. Just place the Olympus over any design, position the pegs and transfer the design instantly to wire. Make delicate chains, links, findings, earrings and much more.

Stock #		
H. HOL-105.00		\$49.95

Don't settle for anything less than the original Nylon Jaw Pliers by EURO TOOL!

NYLON JAW PLIERS

Nylon jaw pliers are a must for straightening wire, especially colored wire. Not just any nylon jaw will do and ours is a high quality nylon which will not damage delicate wire. Stainless, box-jointed with comfort grips. Available in three styles, one with spring. Replacement jaws available. Don't settle for less than the original EURO TOOL nylon jaw pliers.

Stock #	Description	Length	
A. PLR-829.00	Narrow Nylon Jaw Plier	5 $\frac{3}{4}$ " (145mm)	\$19.95
B. PLR-830.00	Nylon Jaw Plier	5 $\frac{3}{4}$ " (145mm)	\$22.50
C. PLR-831.00	Nylon Jaw Plier with Spring	4 $\frac{3}{4}$ " (120mm)	\$13.95
PLR-829.05	Repl. Jaws for PLR-829.00 (pair)		\$4.15
PLR-830.05	Repl. Jaws for PLR-830.00 (pair)		\$4.15
PLR-831.05	Repl. Jaws for PLR-831.00 (pair)		\$4.15

WIRE STRAIGHTENING TWEEZERS

As an economical alternative to our nylon jaw pliers, we now offer nylon jaw tweezers. Our new tweezers take up less space, insure that the user won't grab the wire too firmly, and are easy to use. Made of stainless steel with quality nylon jaws.

Stock #	Length	
D. TWZ-748.00	5 $\frac{1}{4}$ " (135mm)	\$7.95

BEAD TWEEZER

Great bead handling tool. Nicely rounded ends on a sturdy nickel tweezer will make handling almost any size bead an easier task.

Stock #	Length	
E. TWZ-620.00	4 $\frac{5}{8}$ " (118mm)	\$3.95

PEARL-HOLDING TWEEZER

This epoxy-coated tipped tweezer is a must when sorting pearls or other round stones.

Stock #	Length	
F. TWZ-104.84	5 $\frac{3}{4}$ " (145mm)	\$5.95

BEAD/PEARL TWEEZER

A new bead tweezer designed specifically for sorting and handling beads and delicate pearls. This tweezer absolutely cannot scratch because the tip is nylon. The shank is made of high-grade stainless steel for a light touch with excellent grip.

Stock #	Length	
G. TWZ-104.50	6 $\frac{1}{4}$ " (160mm)	\$8.95

STONE/BEAD TWEEZER with SHOVEL

Our stone/bead shovel added onto a medium tip serrated stone tweezer allows more versatility and better handling of stones and beads. This tweezer is made of stainless steel with serrated tips. The combination of stone shovel and tweezer is convenient and time saving.

Stock #	Length	
H. TWZ-705.70	7 $\frac{1}{8}$ " (180mm)	\$4.95

BEAD HANDLING TWEEZER

EURO TOOL has been known for tweezers innovation for years, so we put our heads to work on this one—how to best remove all sizes of beads from kits, bottles and trays without spilling or damaging them. The answer is proper engineering; in this case long tweezers with half round jaws so that the user can go straight down and pick up the desired bead or stone. This design handles any shape or size without damage.

Made of stainless steel with a nice light touch, you'll get years of service from this exclusive EURO TOOL design, which can handle seed beads and beads up to 10.0 mm in diameter.

Stock #	Length	
I. TWZ-104.30	6 $\frac{1}{4}$ " (160mm)	\$6.95

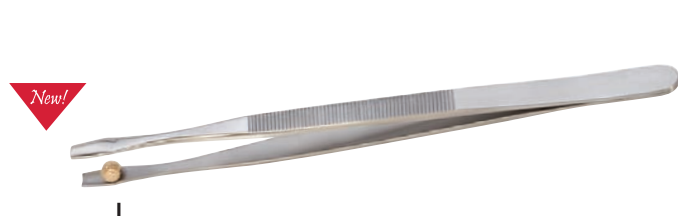
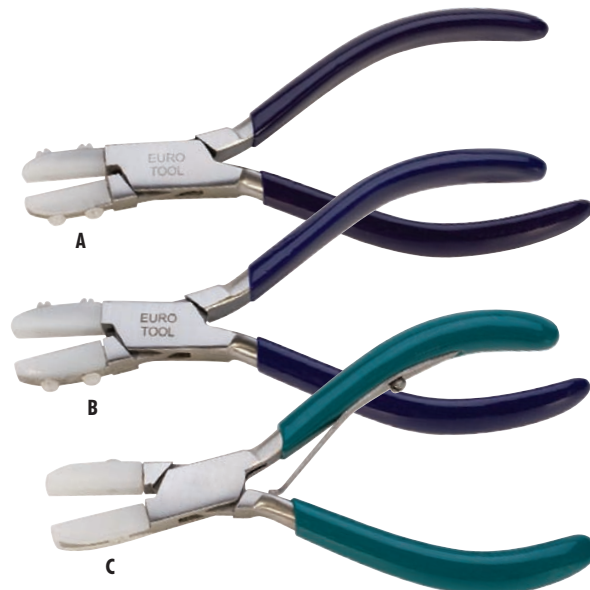



Clear lid keeps projects secure.

New!

A



B

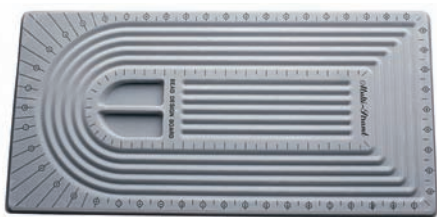

C



D



E



F



G



H

PRO-DESIGN BOARDS

Our Pro-Design bead boards feature heavy, durable plastic with a thick gray flocking to help your beads and designs stay in place when creating. Features half-inch increment marking and three-strand capacity with 6 easy-out compartments to store your beads, findings, needles and other stringing supplies. Our Pro-Design board is also available with a clear lid for secure storage of your projects-in-process or beading on the go. A great choice for classes. This is an exceptionally priced, quality board.

Stock #	Description	Size	
BDT-101.34	Pro-Design Board	13" x 9 1/2"	\$5.95
A. BDT-102.34	Pro-Design Board w/ Lid	13" x 9 1/2"	\$6.95

BASIC BOARD

Small Board allows the user to design necklaces with a maximum of 28" and has five compartments to hold extra beads.

Stock #	Description	Size	
B. BDT-100.28	Basic Board	13 1/4" x 9"	\$5.55

MULTISTRAND DESIGN BOARD

The Multistrand Design Board can string up to five strands at once, up to 42" long. This board is our best seller and features two compartments and six center grooves to organize your beads.

Stock #	Description	Size	
C. BDT-105.42	Multistrand Design Board	21 1/8" x 10 1/2"	\$8.85

LARGE SINGLE STRAND BOARD

The Larger Single Strand Board will accommodate up to a 40" necklace and has three large compartments to hold extra beads.

Stock #	Description	Size	
D. BDT-100.40	Large Single Strand Board	21 1/4" x 8"	\$7.45

FOUR ROW STRAIGHT BOARD

The popular Four Row Straight Board is made for designing multistrand necklaces up to 20" and has six compartments.

Stock #	Description	Size	
E. BDT-104.20	Four Row Straight Board	21 1/4" x 8"	\$7.45

EASY DESIGN BEAD BOARD

This large bead board features ten compartments for holding beads and other beading supplies. Flocked in a neutral gray, this tray will accommodate up to three strands and is our favorite.

Stock #	Description	Size	
F. BDT-113.42	Easy Design Bead Board	18 3/4" x 10"	\$10.95

BEAD MATS

Beading mats are a take anywhere work surface for beading. Made of synthetic fabric for easy cleaning and long life, they are wrinkle-free and washable. Stringing was never easier because beads do not roll off the soft, thick surface of the mats. When you're finished, roll the mats up for storage. They are light and portable. Our set of three bead mats includes one each of gray, cream and dark blue. Or buy in bulk quantities of 50 for greater savings.

Stock #	Size	Qty.	
G. BDT-330.00	9" x 12"	pk/3	\$6.95
BDT-335.01	9" x 12" - Beige	pk/50	\$20.95
BDT-335.02	9" x 12" - Gray	pk/50	\$20.95
BDT-335.03	9" x 12" - Blue	pk/50	\$20.95



WOOD BEAD TRAY

Keep beads and supplies from rolling and scattering in your work area. This shallow wood tray has a felt lining to allow for layout and design as well as a small hole in the corner for easy putaway of beads and small parts. Simply tip and pour directly into storage containers.

Stock #	Size	
H. BDT-200.00	3/4" x 14 1/2" x 11 1/2"	\$10.95

Give your projects a little twist!

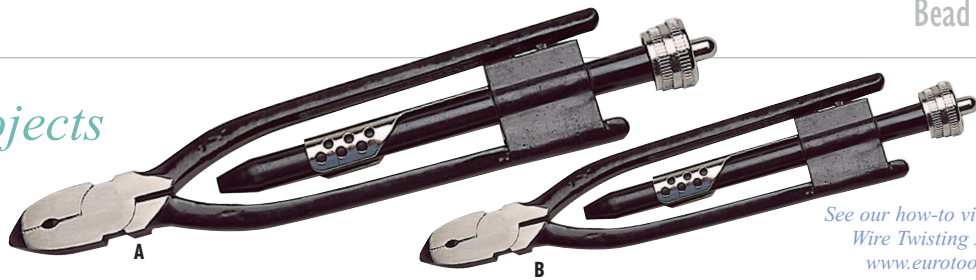

See our how-to video on the Wire Twisting Plier at www.eurotool.com

WIRE TWISTING PLIERS

Safely twists wire up to 18 ga. Simple one-pull action and automatic return twists wire quickly into a strand that won't unravel. Hardened and tempered.

Stock #	Length	
A. PLR-799.00	9" (230mm)	\$22.55
B. PLR-799.50	6" (150mm)	\$20.45



Copper wire twisted then hammered.

Two wire colors twisted together.

Wire twisted, doubled over and twisted again.

WOOD HOLDER FOR BEADS

A handy idea for bead stringers when using our DIB-275.00 bead reamer or HDP-375.00 motorized bead reamer. This wooden "hand vise," developed exclusively by EURO TOOL, will not scratch delicate beads, but holds them securely while cleaning or reaming holes.

Stock #	Length	
C. HOL-177.00	6 3/4"	\$5.95



Wood Holder will not scratch delicate beads!

PEARL/BEAD DRILLING VISE

Make pearl and bead drilling easy with this clever vise. Two brass cupped jaws hold the stone securely and lined up perfectly centered to allow drilling from both sides without breaking or cracking. The hole is large enough to accept a 1mm drill. Use our high speed twist drills (pg. 79) with this vise.

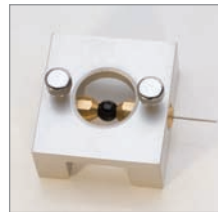

Stock #		
D. HOL-178.00		\$39.95

New!



2" SPRING CLAMP

There are a variety of uses for our new 2" spring clamps. Excellent for holding bead cord or wire when stringing. Remove the PVC covers and you can use for soldering. Nice spring tension holds objects securely. Sold in bags of ten.



Stock #	Description	
E. HOL-172.02	2" Spring Clamp, pk/10	\$4.95

RHINESTONE APPLICATOR

Our applicator wand is perfect for attaching Rhinestones. Kit contains one wand, support stand, and six hot-fix tips, plus complete directions. Wand is 110 Volt and used with applicator glue to secure rhinestones quickly, accurately and easily.

Stock #	Length	
F. PEN-400.00	7"	\$19.95

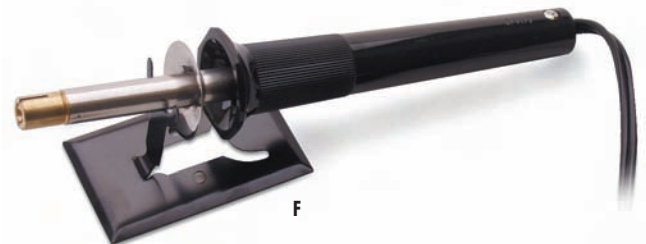

MAGICAL CRIMPER

This tool was created exclusively for use with 2mm sterling silver and gold-filled tubular crimp beads and .019" or .014" flex wire. Just a few easy steps will transform a 2mm crimp into a round bead.

Stock #	Description	
G. PLR-578.04	Magical Crimper for .014 Wire	\$19.95
H. PLR-578.05	Magical Crimper for .019 Wire	\$19.95



Step 1

Step 2

Step 3

Step 4





Bead Tips/Knot Covers



Crimp Covers



Seamed Beads/Crimp Covers



Foldover End Cord Fasteners



Spring Cord Ends



EZ Crimp End Cord Fasteners

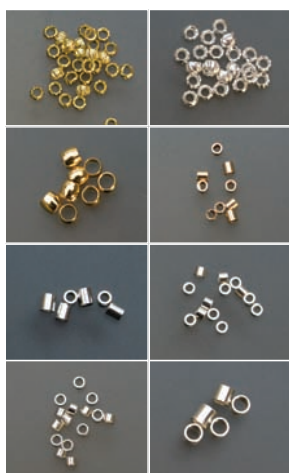

Crimp Beads



French Wire (enlarged view)



BEAD TIPS/ KNOT COVERS

Bead Tips, or knot covers, give your jewelry a professional finished look. Hide the end knots on jewelry cord and connect the strands to a jump ring or clasp. Available in single or double cup, plated or sterling silver.

Stock #	Description	Qty		Stock #	Description	Qty.	
BDS-210.05	Single – Gold Plated	pk/144	\$2.65	BDS-215.05	Double – Gold Plated	pk/144	\$6.15
BDS-210.06	Single – Sterling Silver Plated	pk/144	\$2.40	BDS-215.06	Double – Sterling Silver Plated	pk/144	\$5.45
BDS-210.16	Single – Sterling Silver, 1 mm hole	pk/100	\$15.55	BDS-215.16	Double – Sterling Silver, 0.9mm hole	pk/100	\$30.45

CRIMP COVERS

Crimp covers are pre-opened beads designed to conceal a round or tube crimp giving your piece a finished look. Use the outer jaw of the Mighty Crimpers to easily close the cover over a crimp. The crimp cover resembles a round bead when closed. Available in 3mm (for 2 x 2mm crimps or smaller) and 4mm (for 3 x 2mm crimps or smaller), plated or sterling silver.

Stock #	Description	Qty		Stock #	Description	Qty.	
BDS-233.05	3mm – Gold Plated	pk/144	\$4.65	BDS-234.05	4mm – Gold Plated	pk/144	\$7.30
BDS-233.06	3mm – Silver Plated	pk/144	\$3.55	BDS-234.06	4mm – Silver Plated	pk/144	\$6.20
BDS-233.16	3mm Sterling Silver	pk/100	\$15.95	BDS-234.16	4mm Sterling Silver	pk/100	\$22.75

SEAMED BEADS/CRIMP COVERS

Seamed beads can be used as beads or to cover round or tube crimps. Simply open the closed bead with a beading awl. Place over the crimp and gently squeeze closed with the Mighty Crimper. Available in 3 or 4mm, plated or sterling silver.

Stock #	Description	Qty		Stock #	Description	Qty.	
BDS-243.05	3mm – Gold Plated	pk/1000	\$24.10	BDS-244.05	4mm – Gold Plated	pk/1000	\$47.30
BDS-243.06	3mm – Silver Plated	pk/1000	\$20.45	BDS-244.06	4mm – Silver Plated	pk/1000	\$38.05
BDS-243.16	3mm Sterling Silver	pk/100	\$6.85	BDS-244.16	4mm Sterling Silver	pk/100	\$15.45

END CORD FASTENERS

End cord fasteners are a perfect finish for the latest cord fashions such as leather, rubber, jewelry cable, imitation leather, ribbon and suede cord. Conceals the cord end and allows for a clasp or jump ring to be attached giving it a clean finished look.

- Foldover Open End Cords come open to simply insert the cord and bend each side closed with a pair of chain nose pliers.
- Spring cord ends are easy to use and available in 3 and 4 mm.
- EZ crimp ends offer a secure finish and crimp directly onto beading wire.

Stock #	Description	Color	Qty.	
BDS-307.06	Foldover Open End Cord	Silver Plated – 4mm	pk/144	\$3.75
BDS-307.05	Foldover Open End Cord	Gold Plated – 4mm	pk/144	\$3.95
BDS-303.16	Foldover Open End Cord, Smooth	Sterling Silver – 3mm	pk/10	\$8.95
BDS-305.16	Foldover Open End Cord, Smooth	Sterling Silver – 5mm	pk/10	\$11.25
BDS-323.06	Spring Cord End	Silver Plated – 3mm	pk/144	\$12.45
BDS-324.06	Spring Cord End	Silver Plated – 4mm	pk/144	\$12.60
BDS-308.06	EZ crimp End	Silver Plated	pk/80	\$19.95
BDS-308.05	EZ crimp End	Gold Plated	pk/80	\$22.60
BDS-308.16	EZ crimp End	Sterling Silver	pk/40	\$21.15

CRIMP BEADS

Metal crimp beads and tube crimps are used for attaching Micro Cable, Soft Flex Wire, Beadalon, translucent cord and other beading wire. Use with our Original Bead Crimping Plier for a great finished look. For the smaller crimps you'll need our Micro-Crimper. Available in plated or sterling silver.

Stock #	Description	Color	Qty.	
BDS-100.05	Crimp Bead	Gold (Brass) – 2.5mm dia.	1 oz.	\$13.85
BDS-100.06	Crimp Bead	Silver – 2.5mm dia.	1 oz.	\$12.95
BDS-102.05	Crimp Bead	Gold, Base Metal – 2mm dia.	pk/144	\$4.95
BDS-102.06	Crimp Bead	Silver, Base Metal – 2mm dia.	pk/144	\$4.35
BDS-104.05	Crimp Bead	Gold, Base Metal – 3mm dia.	pk/144	\$10.60
BDS-104.06	Crimp Bead	Silver, Base Metal – 3mm dia.	pk/144	\$9.95
BDS-110.05	Tube Crimp	Gold Filled – 2mm x 2mm	pk/100	\$9.95
BDS-115.06	Mini Tube Crimp	Sterling Silver – 1mm x 0.97mm	pk/100	\$3.45
BDS-117.06	Mini Tube Crimp	Sterling Silver – 1mm x 1.30mm	pk/100	\$4.10
BDS-112.06	Tube Crimp	Sterling Silver – 1.5mm x 2mm	pk/100	\$6.95
BDS-110.06	Tube Crimp	Sterling Silver – 2mm x 2mm	pk/100	\$7.55
BDS-118.06	Tube Crimp	Sterling Silver – 3mm x 3mm	pk/100	\$23.80

FRENCH WIRE

French wire is tightly coiled wire used to complete your pearl and bead projects for a professional look. Also known as "bullion" or "gimp," French wire covers the ends of bead cord for added strength and protection and can be used as an alternative to bead tips. We offer silver and gold plated in four sizes. All are packaged in 1M lengths. Made in France.

Stock #	Description	Qty		Stock #	Description	Qty.	
BDS-408.05	Gold/Yellow – 0.80mm	1 meter	\$3.75	BDS-408.06	Silver/White – 0.80mm	1 meter	\$3.55
BDS-409.05	Gold/Yellow – 0.90mm	1 meter	\$3.75	BDS-409.06	Silver/White – 0.90mm	1 meter	\$3.55
BDS-410.05	Gold/Yellow – 1.00mm	1 meter	\$4.25	BDS-410.06	Silver/White – 1.00mm	1 meter	\$4.05
BDS-411.05	Gold/Yellow – 1.10mm	1 meter	\$4.25	BDS-411.06	Silver/White – 1.10mm	1 meter	\$4.05
BDS-412.05	Gold/Yellow – 1.20mm	1 meter	\$4.30	BDS-412.06	Silver/White – 1.20mm	1 meter	\$4.10

EASY EAR WIRE™

Are you spending too much on ear wires, buying large quantities for economy, just to have them sit on a shelf for weeks or even years? The Easy Ear Wire™ is so easy and quick you will not need to keep an inventory of ear wires for your earrings.



Simply make them as you need them for less than half the usual cost. Easy to use, fully automatic and hand operated; just put in a straight piece of wire and in seconds you will have an elegant ear wire ready for use. Comes with complete instructions as well as additional instruction sheet for making other wire jewelry components. Patent No. 7,073,367.

Stock #		
A. HOL-100.00		\$24.95

B. ENGLISH BEADING NEEDLES

The quality of English needles is widely respected around the world, based on a 250-year tradition of skilled craftsmanship passed down from generation to generation. Relatively easy to thread, John James English beading needles are superior quality beading needles and are less likely to bend than cheaper versions. Four needles per card.

Stock #	Size		
BDN-104.10	#10		\$1.85
BDN-104.12	#12		\$1.85
BDN-104.13	#13		\$1.95
BDN-104.15	#15		\$2.35
BDN-104.04	4 Needle Assortment (Includes 2 each #10, 1 each #12, 1 each #13)		\$1.85

GRIFFIN BEADING NEEDLES

From Griffin, the maker of our superior bead cord, we offer stainless steel beading needles in three different sizes. Made in Germany. Sold by packs of 25.

Stock #	Size	Length	Qty.	
C. BDN-760.00	Fine	3 3/4"	pk/25	\$5.15
D. BDN-762.00	Medium	3 3/4"	pk/25	\$5.15
E. BDN-764.00	Coarse	3 3/4"	pk/25	\$5.15

NEEDLE/WIRE HOLDER

The best little hemostats available because they open and close so easily—squeeze to close, squeeze to open. This unique locking system makes them perfect for clamping or holding multi-strand wire or cord while beading. We recommend at least two on every bench, and they are relatively inexpensive, box jointed and made of stainless steel without serrations so they will not scratch.

Stock #	Length	
F. HEM-150.15	5" (125mm)	\$8.95

BEAD-EZ SPINNER for SEED BEADS

With a simple twist of the spindle, watch the beads load on to the needle with ease. If you are looking for a fast way to thread seed beads, this is the answer. The Bead-EZ Spinner is made of hardwood with a wide base and well proportioned easy access bowl. One big eye hook needle included.

Stock #		
G. BDT-250.00		\$29.95

H. LEATHER CORD

Our genuine leather cord offers a smooth finish, consistent color, and flexibility. Quality round cord made in India ideal for all your leather jewelry crafting requirements. Available in black, brown, and natural with two options of lengths, you can create timeless designs from the traditional to contemporary.

10M Length		100M Length		Description
Stock #		Stock #		
BDC-553.05	\$5.25	BDC-553.06	\$31.90	Black Round Cord – 0.50mm
BDC-553.10	\$5.25	BDC-553.11	\$31.90	Black Round Cord – 1.00mm
BDC-553.20	\$5.85	BDC-553.21	\$35.95	Black Round Cord – 2.00mm
BDC-553.30	\$7.40	BDC-553.31	\$48.25	Black Round Cord – 3.00mm
BDC-551.05	\$5.25	BDC-551.06	\$33.95	Brown Round Cord – 0.50mm
BDC-551.10	\$5.25	BDC-551.11	\$33.95	Brown Round Cord – 1.00mm
BDC-551.20	\$5.85	BDC-551.21	\$38.55	Brown Round Cord – 2.00mm
BDC-555.05	\$5.25	BDC-555.06	\$33.95	Natural Round Cord – 0.50mm
BDC-555.10	\$5.25	BDC-555.11	\$33.95	Natural Round Cord – 1.00mm
BDC-555.20	\$5.85	BDC-555.21	\$38.55	Natural Round Cord – 2.00mm



See our instructional video at www.eurotool.com



Easy Ear Wire™ can be used to make a variety of wire jewelry components.



New!



We carry an extensive line of Griffin beading materials. Each card features top-quality German-made Griffin bead cord. This is the finest quality tight-woven silk or nylon cord available. 6.5 feet (2 meters) of brilliantly died, color-fast cord per card with needle attached. Simply take the needle from the card and off you go! The twisted stainless steel needle saves threading time. Doubling the thread is not necessary. There is no simpler, quicker or better way to thread beads! Please order by stock number prefix plus size (i.e. Nylon White #3 is BDC-101.03).



Thread Size Chart

— #0 = 0.30mm	— #6 = 0.70mm
— #1 = 0.35mm	— #7 = 0.75mm
— #2 = 0.45mm	— #8 = 0.80mm
— #3 = 0.50mm	— #10 = 0.90mm
— #4 = 0.60mm	— #12 = 0.98mm
— #5 = 0.65mm	

A. NYLON (POLYAMID) THREAD

Color	Stock #	Nylon Sizes	#0 – 6	#7 – 12
White	BDC-101.xx	0, 1, 2, 3, 4, 5, 6, 7, 8, 10, 12	\$1.05	\$1.20
Pink	BDC-102.xx	0, 1, 2, 3, 4, 5, 6, 7, 8, 10, 12	\$1.05	\$1.20
Dark Pink	BDC-103.xx	0, 1, 2, 3, 4, 5, 6, 7, 8, 10, 12	\$1.05	\$1.20
Coral	BDC-104.xx	0, 1, 2, 3, 4, 5, 6, 7, 8, 10, 12	\$1.05	\$1.20
Red	BDC-105.xx	0, 1, 2, 3, 4, 5, 6, 7, 8, 10, 12	\$1.05	\$1.20
Garnet	BDC-106.xx	0, 1, 2, 3, 4, 5, 6, 7, 8, 10, 12	\$1.05	\$1.20
Yellow	BDC-107.xx	0, 1, 2, 3, 4, 5, 6, 7, 8, 10, 12	\$1.05	\$1.20
Amber	BDC-108.xx	0, 1, 2, 3, 4, 5, 6, 7, 8, 10, 12	\$1.05	\$1.20
Blue	BDC-109.xx	0, 1, 2, 3, 4, 5, 6, 7, 8, 10, 12	\$1.05	\$1.20
Dark Blue	BDC-110.xx	0, 1, 2, 3, 4, 5, 6, 7, 8, 10, 12	\$1.05	\$1.20
Lilac	BDC-111.xx	0, 1, 2, 3, 4, 5, 6, 7, 8, 10, 12	\$1.05	\$1.20
Amethyst	BDC-112.xx	0, 1, 2, 3, 4, 5, 6, 7, 8, 10, 12	\$1.05	\$1.20
Turquoise	BDC-113.xx	0, 1, 2, 3, 4, 5, 6, 7, 8, 10, 12	\$1.05	\$1.20
Jade Green	BDC-114.xx	0, 1, 2, 3, 4, 5, 6, 7, 8, 10, 12	\$1.05	\$1.20
Green	BDC-116.xx	0, 1, 2, 3, 4, 5, 6, 7, 8, 10, 12	\$1.05	\$1.20
Cornelian	BDC-117.xx	0, 1, 2, 3, 4, 5, 6, 7, 8, 10, 12	\$1.05	\$1.20
Beige	BDC-120.xx	0, 1, 2, 3, 4, 5, 6, 7, 8, 10, 12	\$1.05	\$1.20
Brown	BDC-121.xx	0, 1, 2, 3, 4, 5, 6, 7, 8, 10, 12	\$1.05	\$1.20
Gray	BDC-122.xx	0, 1, 2, 3, 4, 5, 6, 7, 8, 10, 12	\$1.05	\$1.20
Black	BDC-123.xx	0, 1, 2, 3, 4, 5, 6, 7, 8, 10, 12	\$1.05	\$1.20

B. 100% SILK THREAD

Color	Stock #	Silk Sizes	#0 – 6	#7 – 12
White	BDC-231.xx	0, 1, 2, 3, 4, 5, 6, 7, 8, 10, 12	\$1.39	\$1.59
Pink	BDC-232.xx	0, 1, 2, 3, 4, 5, 6, 7, 8, 10, 12	\$1.39	\$1.59
Dark Pink	BDC-233.xx	0, 1, 2, 3, 4, 5, 6, 7, 8, 10, 12	\$1.39	\$1.59
Coral	BDC-234.xx	0, 1, 2, 3, 4, 5, 6, 7, 8, 10, 12	\$1.39	\$1.59
Red	BDC-235.xx	0, 1, 2, 3, 4, 5, 6, 7, 8, 10, 12	\$1.39	\$1.59
Garnet	BDC-236.xx	0, 1, 2, 3, 4, 5, 6, 7, 8, 10, 12	\$1.39	\$1.59
Yellow	BDC-237.xx	0, 1, 2, 3, 4, 5, 6, 7, 8, 10, 12	\$1.39	\$1.59
Amber	BDC-238.xx	0, 1, 2, 3, 4, 5, 6, 7, 8, 10, 12	\$1.39	\$1.59
Blue	BDC-239.xx	0, 1, 2, 3, 4, 5, 6, 7, 8, 10, 12	\$1.39	\$1.59
Dark Blue	BDC-240.xx	0, 1, 2, 3, 4, 5, 6, 7, 8, 10, 12	\$1.39	\$1.59
Lilac	BDC-241.xx	0, 1, 2, 3, 4, 5, 6, 7, 8, 10, 12	\$1.39	\$1.59
Amethyst	BDC-242.xx	0, 1, 2, 3, 4, 5, 6, 7, 8, 10, 12	\$1.39	\$1.59
Turquoise	BDC-243.xx	0, 1, 2, 3, 4, 5, 6, 7, 8, 10, 12	\$1.39	\$1.59
Jade Green	BDC-244.xx	0, 1, 2, 3, 4, 5, 6, 7, 8, 10, 12	\$1.39	\$1.59
Green	BDC-246.xx	0, 1, 2, 3, 4, 5, 6, 7, 8, 10, 12	\$1.39	\$1.59
Cornelian	BDC-247.xx	0, 1, 2, 3, 4, 5, 6, 7, 8, 10, 12	\$1.39	\$1.59
Beige	BDC-249.xx	0, 1, 2, 3, 4, 5, 6, 7, 8, 10, 12	\$1.39	\$1.59
Brown	BDC-251.xx	0, 1, 2, 3, 4, 5, 6, 7, 8, 10, 12	\$1.39	\$1.59
Gray	BDC-252.xx	0, 1, 2, 3, 4, 5, 6, 7, 8, 10, 12	\$1.39	\$1.59
Black	BDC-253.xx	0, 1, 2, 3, 4, 5, 6, 7, 8, 10, 12	\$1.39	\$1.59



100% Jewelry Silk Spool Length		
Size	Length	Dia.
#1	310M	.15mm
#2	200M	.20mm
#3	125M	.27mm
#4	90M	.30mm
#5	80M	.33mm
#6	65M	.35mm
#7	50M	.38mm
#8	40M	.42mm

100% JEWELRY SILK

100% real silk thread of the highest quality for stringing beads and pearls. This German-made thread is strong, tough, supple and soft to the touch with very little stretch. Use with our Griffin Beading needles and you are ready for perfect bead stringing. Priced per spool. Please order by stock number prefix plus size: (i.e. White #3 is BDC-331.03).

Color	Stock #	Sizes	
White	BDC-331.xx	1, 2, 3, 4, 5, 6, 7, 8	\$10.45
Black	BDC-353.xx	2, 3, 4, 6, 8	\$10.45
Pink	BDC-332.xx	6, 8	\$10.45
Coral	BDC-334.xx	6, 8	\$10.45
Garnet	BDC-336.xx	6, 8	\$10.45
Dark Blue	BDC-340.xx	6, 8	\$10.45
Amethyst	BDC-342.xx	6, 8	\$10.45
Turquoise	BDC-343.xx	6, 8	\$10.45
Green	BDC-346.xx	6, 8	\$10.45
Brown	BDC-351.xx	6, 8	\$10.45
Gray	BDC-352.xx	6, 8	\$10.45



TUFF CORD and SILK ALIKE

Two unique EURO TOOL products which offer the best quality American-made beading cord available. Both are synthetic fibers that are stronger than their respective usual fibers—nylon and silk—because both are made of three strands of long fiber, not just two. Neither Tuff Cord nor Silk Alike will stretch or stain, and both resist fraying and shredding. Tuff Cord can be used without a needle!



All Tuff Cord \$2.45



Tuff Cord Color	#0	#1	#2	#3	#5	#6	#7
White	BDC-501.00	BDC-501.01	BDC-501.02	BDC-501.03	BDC-501.05	BDC-501.06	BDC-501.07
Pink		BDC-502.01	BDC-502.02	BDC-502.03	BDC-502.05		
Rose		BDC-503.01		BDC-503.03	BDC-503.05		
Red		BDC-505.01	BDC-505.02	BDC-505.03	BDC-505.05		
Burgundy		BDC-506.01		BDC-506.03	BDC-506.05		
Gold		BDC-508.01	BDC-508.02	BDC-508.03	BDC-508.05		
Blue		BDC-509.01	BDC-509.02	BDC-509.03	BDC-509.05		
Navy		BDC-510.01	BDC-510.02	BDC-510.03	BDC-510.05		
Lavender		BDC-511.01	BDC-511.02	BDC-511.03	BDC-511.05		
Purple		BDC-512.01	BDC-512.02	BDC-512.03	BDC-512.05		
Turquoise		BDC-513.01	BDC-513.02	BDC-513.03	BDC-513.05		
Teal		BDC-514.01		BDC-514.03	BDC-514.05		
Green		BDC-516.01	BDC-516.02	BDC-516.03	BDC-516.05		
Brown		BDC-521.01	BDC-521.02	BDC-521.03	BDC-521.05		
Black	BDC-523.00	BDC-523.01	BDC-523.02	BDC-523.03	BDC-523.05	BDC-523.06	BDC-523.07
Hematite		BDC-524.01		BDC-524.03	BDC-524.05		

Tuff Cord/Silk Alike Size Chart

Size	Length	Dia.
#0	145 yds.	.0078"
#1	98 yds.	.0108"
#2	66 yds.	.0132"
#3	49 yds.	.0162"
#4	36 yds.	.0192"
#5	33 yds.	.0216"
#6	24 yds.	.0288"
#7	18 yds.	.0348"



SILK ALIKE

Stock #	Silk Alike	Color	
BDC-631.00	#0 (B)	White	\$4.10
BDC-631.01	#1 (D)	White	\$4.10
BDC-631.02	#2 (E)	White	\$4.10
BDC-631.03	#3 (F)	White	\$4.10



GRIFFIN ELASTIC CORD

Griffin elastic cord offers the best in elasticity and strength. It is resistant to chemicals and will last longer than other types of elastic cord. Available in clear on handy spools in lengths of 5 meters (16.40 ft), 25 meters (82 ft) and 100 meters (328 ft). Made in Germany.

Stock #	Description	Spool Length	
BDC-470.00	0.5mm Clear	5 Meters	\$2.55
BDC-471.00	0.5mm Clear	25 Meters	\$6.25
BDC-472.00	0.5mm Clear	100 Meters	\$17.15
BDC-475.00	0.7mm Clear	5 Meters	\$2.55
BDC-476.00	0.7mm Clear	25 Meters	\$6.25
BDC-477.00	0.7mm Clear	100 Meters	\$17.15
BDC-480.00	1.0mm Clear	5 Meters	\$2.55
BDC-481.00	1.0mm Clear	25 Meters	\$6.25
BDC-482.00	1.0mm Clear	100 Meters	\$17.15



ELASTICITY™

Soft and flexible, yet strong, Elasticity™ stretchy bead and jewelry cord can be used for a variety of popular beading and jewelry applications. Three sizes are available: 0.5mm, 0.8mm and 1.0mm. All sizes are offered in clear and black with the 0.5mm size also offered in colors. Two spool lengths to choose from to satisfy all project requirements.

Stock #	Description	Color	Spool Length	
BDC-450.00	0.5mm	Clear	25 Meters	\$7.00
BDC-450.02	0.5mm	Black	25 Meters	\$7.00
BDC-455.00	0.8mm	Clear	25 Meters	\$7.00
BDC-455.02	0.8mm	Black	25 Meters	\$7.00
BDC-460.00	1.0mm	Clear	25 Meters	\$7.00
BDC-460.02	1.0mm	Black	25 Meters	\$7.00
BDC-451.00	0.5mm	Clear	100 Meters	\$20.60
BDC-451.02	0.5mm	Black	100 Meters	\$20.60
BDC-456.00	0.8mm	Clear	100 Meters	\$20.60
BDC-456.02	0.8mm	Black	100 Meters	\$20.60
BDC-461.00	1.0mm	Clear	100 Meters	\$20.60
BDC-461.02	1.0mm	Black	100 Meters	\$20.60



Beautiful permanent colored copper wire in a wide range of options to fit your needs. Our wire is the perfect inspiration you need for all of your creative projects.

Design jewelry, wire art, sculpture and more!

ARTISTIC WIRE SPOOLS













Wide variety of colors and gauges in convenient, easy to store spools. See chart below for availability of colors/gauges and yards per spool for each gauge.

Color	18 ga./10 yds. \$3.75	20 ga./15 yds. \$3.75	22 ga./15 yds. \$3.25	24 ga./20 yds. \$3.25	26 ga./30 yds. \$5.00	28 ga./40 yds. \$5.90	30 ga./50 yds. \$6.96
Aqua	BDC-803.01	BDC-804.01	BDC-805.01	BDC-806.01	BDC-807.01	BDC-808.01	
Black	BDC-803.02	BDC-804.02	BDC-805.02	BDC-806.02	BDC-807.02	BDC-808.02	
Blue				BDC-806.03			
Dark Blue	BDC-803.031	BDC-804.031	BDC-805.031	BDC-806.031	BDC-807.031	BDC-808.031	BDC-809.031
Powder Blue			BDC-805.04	BDC-806.04	BDC-807.04	BDC-808.04	BDC-809.04
Brown	BDC-803.05	BDC-804.05	BDC-805.05	BDC-806.05	BDC-807.05		
Light Brown				BDC-806.051			
Green	BDC-803.06	BDC-804.06	BDC-805.06		BDC-807.06	BDC-808.06	BDC-809.06
Kelly Green				BDC-806.07	BDC-807.07	BDC-808.07	
Lavender				BDC-806.08	BDC-807.08	BDC-808.08	
Magenta			BDC-805.09	BDC-806.09		BDC-808.09	
Natural	BDC-803.10	BDC-804.10	BDC-805.10	BDC-806.10	BDC-807.10	BDC-808.10	BDC-809.10
Orange					BDC-807.11	BDC-808.11	
Flesh						BDC-808.12	
Pink					BDC-807.121	BDC-808.121	
Purple	BDC-803.13	BDC-804.13	BDC-805.13	BDC-806.13	BDC-807.13	BDC-808.13	BDC-809.13
Red	BDC-803.14	BDC-804.14	BDC-805.14	BDC-806.14	BDC-807.14	BDC-808.14	BDC-809.14
Salmon					BDC-807.15	BDC-808.15	
Turquoise					BDC-807.16	BDC-808.16	
Violet			BDC-805.17			BDC-808.17	
Egg White			BDC-805.18				
Yellow						BDC-808.19	
Grape					BDC-807.20	BDC-808.20	
Grey			BDC-805.21	BDC-806.21			
Bare Copper	BDC-803.22	BDC-804.22	BDC-805.22	BDC-806.22		BDC-808.22	BDC-809.22
Tinned Copper	BDC-803.23	BDC-804.23	BDC-805.23	BDC-806.23	BDC-807.23	BDC-808.23	BDC-809.23
Gun Metal	BDC-803.24	BDC-804.24	BDC-805.24	BDC-806.24			
Burgundy	BDC-803.25	BDC-804.25	BDC-805.25	BDC-806.25			
Brass (non-tarnish)	BDC-803.26	BDC-804.26	BDC-805.26	BDC-806.26	BDC-807.26	BDC-808.26	



A. ARTISTIC WIRE BAG PAKS

This is an excellent product for display. Handy 25 ft. lengths of Artistic Wire in gauges 14–20. Bag Paks are the ideal wire to use with our Olympus WigJig or any of your favorite wire bending tools.

Color		14 Gauge 10 ft.	16 Gauge 10 ft.	18 Gauge 25 ft.	20 Gauge 25 ft.	22 Gauge 25 ft.
	Aqua	BDC-851.01	BDC-852.01	BDC-833.01	BDC-834.01	BDC-835.01
	Black	BDC-851.02	BDC-852.02	BDC-833.02	BDC-834.02	BDC-835.02
	Dark Blue			BDC-833.031	BDC-834.031	BDC-835.031
	Brown	BDC-851.05	BDC-852.05	BDC-833.05	BDC-834.05	BDC-835.05
	Green	BDC-851.06	BDC-852.06	BDC-833.06	BDC-834.06	BDC-835.06
	Natural	BDC-851.10	BDC-852.10	BDC-833.10	BDC-834.10	BDC-835.10
	Red	BDC-851.14	BDC-852.14	BDC-833.14	BDC-834.14	BDC-835.14
	Violet			BDC-833.17		
	Bare Copper	BDC-851.22	BDC-852.22	BDC-833.22	BDC-834.22	BDC-835.22
	Tinned Copper	BDC-851.23	BDC-852.23	BDC-833.23	BDC-834.23	BDC-835.23
	Gun Metal		BDC-852.24	BDC-833.24		BDC-835.24
	Burgundy		BDC-852.25	BDC-833.25		



ARTISTIC BAG PAKS

14 Gauge	10 foot	\$6.50
16 Gauge	10 foot	\$6.50
18 Gauge	25 foot	\$5.75
20 Gauge	25 foot	\$5.75
22 Gauge	25 foot	\$5.75

B. ARTISTIC COLORED SILVER WIRE

Colored silver wire gives a vivid metallic hue not available with copper based wire. Give your project a new color dimension with colored silver wire. Available on spools in two gauges and six color varieties as well as non-tarnish silver.

Stock #	Gauge	Spool Length	Color	
BDC-827.31	26 Gauge	30 yards	Pearcock Blue	\$10.10
BDC-827.32	26 Gauge	30 yards	Rose	\$10.10
BDC-827.33	26 Gauge	30 yards	Gold	\$10.10
BDC-827.36	26 Gauge	30 yards	Blue	\$10.10
BDC-827.38	26 Gauge	30 yards	Plum	\$10.10
BDC-828.31	28 Gauge	40 yards	Pearcock Blue	\$10.90
BDC-828.32	28 Gauge	40 yards	Rose	\$10.90
BDC-828.33	28 Gauge	40 yards	Gold	\$10.90
BDC-828.36	28 Gauge	40 yards	Blue	\$10.90
BDC-828.38	28 Gauge	40 yards	Plum	\$10.90



Vivid colored silver wire adds new color dimension to any project.

C. ARTISTIC SILVER NON-TARNISH WIRE

Beautiful clear-coated silver wire will not tarnish for all your creative designs.

Stock #	Gauge	Spool Length	Color	
BDC-823.40	18 Gauge	25 feet	Silver (non-tarnish)	\$5.50
BDC-824.40	20 Gauge	25 feet	Silver (non-tarnish)	\$5.50
BDC-825.40	22 Gauge	10 yards	Silver (non-tarnish)	\$4.99
BDC-826.40	24 Gauge	15 yards	Silver (non-tarnish)	\$4.99
BDC-827.40	26 Gauge	30 yards	Silver (non-tarnish)	\$10.10
BDC-828.40	28 Gauge	40 yards	Silver (non-tarnish)	\$10.90



D. "BUY THE DOZEN"

A great way to purchase Artistic Wire – “buy” the dozen. Twelve small spools of different colors containing 5 yards on each spool in a convenient hang-up package. Available in 22, 24 and 26 gauge, and also in 26 gauge silver. Colors may vary per package.

Stock #	Description	
BDC-860.22	22 Gauge	\$11.99
BDC-860.24	24 Gauge	\$11.99
BDC-860.26	26 Gauge	\$11.99
BDC-861.26	26 Gauge, Silver	\$15.99



The Olympus WigJig™ is the perfect companion to help you form and create wire designs. See page 10.



SOFT TOUCH™ WIRE

The beading wire that redefined elegance, Soft Touch™ wire is the most flexible wire on the market. 50% softer than original SoftFlex, Soft Touch™ Wire drapes and feels like thread. Soft Touch™ Wire is available in four diameters: very fine, fine, medium and heavy. Soft Touch™ Wire is supple enough that it can be knotted easily. Your designs will have the grace of silk and the strength of steel.

Stock #	Size	Diameter	Color	Price	Stock #	Size	Diameter	Color	Price
BDC-400.10	30 ft.	.010 Very Fine	Clear	\$7.69	BDC-401.10	100 ft.	.010 Very Fine	Clear	\$23.50
BDC-400.14	30 ft.	.014 Fine	Clear	\$11.99	BDC-401.14	100 ft.	.014 Fine	Clear	\$38.00
BDC-400.19	30 ft.	.019 Medium	Clear	\$16.50	BDC-401.19	100 ft.	.019 Medium	Clear	\$53.00
BDC-400.24	30 ft.	.024 Heavy	Clear	\$14.50	BDC-401.24	100 ft.	.024 Heavy	Clear	\$46.00

SOFT FLEX EXTREME 925™

Extreme 925™ Flex Wire is sterling silver over steel with a premium, nylon coating. This bright and attractive wire will not tarnish and is meant to be shown! The Extreme 925™ Flex Wire will allow you to have consistency in finishing your designs as it will match all of your sterling silver findings and chain. Use this gorgeous wire for free floating necklaces, pendants and for general stringing to add sparkle and shine.

Stock #	Size	Diameter	Color	Price	Stock #	Size	Diameter	Color	Price
BDC-770.14	30 ft.	.014	Sterling Silver	\$16.95	BDC-771.14	30 ft.	.014	Sterling Silver	\$27.95
BDC-770.19	30 ft.	.019	Sterling Silver	\$19.95	BDC-771.19	30 ft.	.019	Sterling Silver	\$32.95
BDC-770.24	30 ft.	.024	Sterling Silver	\$23.95	BDC-771.24	30 ft.	.024	Sterling Silver	\$39.95

ECONOFLEX™ WIRE

Soft Flex Company introduces Econoflex™ Wire, a beading wire for beginners, crafters and price conscious hobbyists! This product line is 7 strands of woven stainless steel wire, coated in nylon. It is available in 7 designer colors in addition to steel grey, in diameters: very fine (.010), fine (.014) and medium (.019).

Color	30 ft. Spools		
	.010 Dia.	.014 Dia.	.019 Dia.
Steel Grey	BDC-431.00	BDC-434.00	BDC-439.00
Snow White	BDC-431.01	BDC-434.01	BDC-439.01
Cinnamon Red	BDC-431.05	BDC-434.05	BDC-439.05
Plum	BDC-431.12	BDC-434.12	BDC-439.12
Spring Green	BDC-431.16	BDC-434.16	BDC-439.16
Autumn Brown	BDC-431.22	BDC-434.22	BDC-439.22
Steel Blue	BDC-431.10	BDC-434.10	BDC-439.10
Midnight Black	BDC-431.23	BDC-434.23	BDC-439.23
All Econoflex Wire Spools			\$2.99



SOFT FLEX WIRE

The ultimate in nylon coated jewelry and beading wire. Fast becoming the standard for professionals and hobbyists. Forty-nine strands of stainless steel wire encased in nylon for the unbeatable combination of strength and flexibility (.014 diameter has 21 strands). Available in two spool lengths and three wire sizes and many colors including metallic copper and antique brass. Metallics will enhance any jewelry design and allow the technology of today to reinvigorate the findings of yesterday.

Diameter	Description	30 ft.	100 ft.
.014"	Clear	\$9.20	\$29.00
.014"	Colors	\$9.80	\$31.00
.014"	Metallics	\$10.89	\$35.00
.019"	Clear	\$13.80	\$43.00
.019"	Colors	\$15.00	\$48.00
.019"	Metallics	\$15.50	\$49.50
.024"	Clear	\$11.90	\$36.50
.024"	Colors	\$13.80	\$43.00
.024"	Metallics	\$13.20	\$42.00

Color	30 ft. Spools			100 ft. Spools		
	.014 Dia.	.019 Dia.	.024 Dia.	.014 Dia.	.019 Dia.	.024 Dia.
Clear	BDC-414.00	BDC-419.00	BDC-424.00	BDC-415.00	BDC-420.00	BDC-425.00
White	BDC-414.01	BDC-419.01		BDC-415.01	BDC-420.01	
Pink		BDC-419.02			BDC-420.02	
Red		BDC-419.05	BDC-424.05		BDC-420.05	
Yellow		BDC-419.06			BDC-420.06	
Butterscotch		BDC-419.08	BDC-424.08		BDC-420.08	
Dark Blue		BDC-419.10	BDC-424.10		BDC-420.10	
Purple		BDC-419.12	BDC-424.12		BDC-420.12	
Turquoise		BDC-419.13	BDC-424.13		BDC-420.13	
Green		BDC-419.16	BDC-424.16		BDC-420.16	
Black	BDC-414.23	BDC-419.23	BDC-424.23	BDC-415.23	BDC-420.23	BDC-425.23
Bone		BDC-419.24			BDC-420.24	
Golden Bronze	BDC-414.47	BDC-419.47	BDC-424.47	BDC-415.47	BDC-420.47	BDC-425.47
Copper	BDC-414.50	BDC-419.50	BDC-424.50	BDC-415.50	BDC-420.50	BDC-425.50
Antique Brass	BDC-414.60	BDC-419.60	BDC-424.60	BDC-415.60	BDC-420.60	BDC-425.60



Necklace designed by Virginia Barrera using .019/Medium Golden Bronze Soft Flex Wire.

New! New Metallic Colors in Copper and Antique Brass!



BEADALON® 49 STRAND BEAD STRINGING WIRE

Professional Series Beadalon 49 combines the flexibility and convenience of thread with the strength and durability of stainless steel wire. Specially designed for stringing ceramic, glass, metal, and stone beads as well as seed beads and freshwater pearls, Beadalon 49 is the softest and most flexible of all Beadalon varieties. Designs fashioned from Beadalon 49 drape very naturally without kinking. Easy to use without the aid of a beading needle, but is so soft and flexible that it can be knotted. Made in USA.

Stock #	Description	Color	Size	Length	
BDC-323.13	49 Strand	Bright	.013"	30 ft.	\$17.55
BDC-323.15	49 Strand	Bright	.015"	30 ft.	\$13.85
BDC-323.18	49 Strand	Bright	.018"	30 ft.	\$10.75
BDC-323.24	49 Strand	Bright	.024"	30 ft.	\$9.35
BDC-324.15	49 Strand	Black	.015"	30 ft.	\$15.95
BDC-324.18	49 Strand	Black	.018"	30 ft.	\$12.30

BEADALON® 19 STRAND BEAD STRINGING WIRE

Specifically developed for bead stringing, Designer Series Beadalon 19 is an ideal choice for creating treasures with seed beads, freshwater pearls, and ceramic, glass, and stone beads. Contains 19 strands of strong stainless steel. Nylon-coated for increased kink and abrasion resistance, Beadalon 19 is easy to work with (no needle necessary), super-strong, and renders secure jewelry that lasts! Made in USA.

Stock #	Description	Color	Size	Length	
BDC-314.10	19 Strand	Bright	.010"	30 ft.	\$7.95
BDC-314.12	19 Strand	Bright	.012"	30 ft.	\$7.05
BDC-314.15	19 Strand	Bright	.015"	30 ft.	\$6.45
BDC-314.18	19 Strand	Bright	.018"	30 ft.	\$7.30
BDC-314.21	19 Strand	Bright	.021"	30 ft.	\$7.90
BDC-315.12	19 Strand	Black	.012"	30 ft.	\$8.40
BDC-315.15	19 Strand	Black	.015"	30 ft.	\$7.75

BEADALON® 7 STRAND BEAD STRINGING WIRE

Softer and stronger than Tiger Tail and more supple for a smoother drape, Craft Series Beadalon 7 encases seven strands of fine-diameter stainless steel wire within a kink-resistant nylon coating. Beadalon 7 is easy to work with (no needle necessary) and abrasion-resistant for longer-lasting results. Use Beadalon 7 for most general beading designs. Made in USA.

Stock #	Description	Color	Size	Length	
BDC-300.12	7 Strand	Bright	.012"	30 ft.	\$1.85
BDC-300.15	7 Strand	Bright	.015"	30 ft.	\$1.85
BDC-300.18	7 Strand	Bright	.018"	30 ft.	\$2.35
BDC-300.21	7 Strand	Bright	.021"	30 ft.	\$2.35
BDC-301.12	7 Strand	Bright	.012"	100 ft.	\$4.55
BDC-301.15	7 Strand	Bright	.015"	100 ft.	\$4.65
BDC-301.18	7 Strand	Bright	.018"	100 ft.	\$5.55

BEADALON® .925 STERLING SILVER BEADING WIRE

.925 sterling silver wire is for the purist designer that requires absolute softness and flexibility in pure, solid .925 sterling. A thin smooth crystal clear layer of nylon covers the wire to prolong strand life and prevent kinking. Due to the extreme softness, we recommend reserving this .925 wire for your finest quality, most precious designs. Available in 19 strand or 49 strand for designs requiring maximum flexibility and wire visibility.

Stock #	Description	Size	Length	Strands	
BDC-772.24	Sterling Silver	.024	10'	19	\$37.25
BDC-774.18	Sterling Silver	.018	10'	49	\$29.85
BDC-774.24	Sterling Silver	.024	10'	49	\$36.25

BEADALON® 19 STRAND PLATED BEAD STRINGING WIRE

Combine the flexibility and strength of 19 strand wire with the luster of precious metal. Supple 19 strand stainless steel wire is plated with silver or 24K gold precious metal, then coated with clear, soft nylon.

Stock #	Description	Size	Length	Strands	
BDC-752.12	Gold Plated	.012"	15 ft.	19	\$12.25
BDC-752.15	Gold Plated	.015"	15 ft.	19	\$12.10
BDC-752.18	Gold Plated	.018"	15 ft.	19	\$12.45
BDC-752.24	Gold Plated	.024"	15 ft.	19	\$19.15
BDC-762.12	Silver Plated	.012"	15 ft.	19	\$12.25
BDC-762.15	Silver Plated	.015"	15 ft.	19	\$12.10
BDC-762.18	Silver Plated	.018"	15 ft.	19	\$12.45
BDC-762.24	Silver Plated	.024"	15 ft.	19	\$19.15
BDC-763.12	Silver Plated	.012"	30 ft.	19	\$27.95
BDC-763.15	Silver Plated	.015"	30 ft.	19	\$27.95
BDC-763.18	Silver Plated	.018"	30 ft.	19	\$27.95
BDC-763.24	Silver Plated	.024"	30 ft.	19	\$27.95



Necklace designed by Fernando DaSilva using Beadalon 49 strand black .024".



A



B



C



Traditionally for watch crystals, but now a standard for bead artisans.

D



E



F



G

HENRIETTA'S GUM ARABIC

Used to make self-threading needles and seal closing knots. Water soluble, it washes off of hands, tools and beads easily. Directions conveniently on the label. Now available in a non-breakable plastic jar.

Stock #	Net wt.	
G. GLU-110.00	1/2 fl. oz.	\$3.25

A. EURO TOOL MICRO CABLE

Unbreakable stainless steel, nylon-coated wire with seven strands for superior strength (.012 has three strands). Super tough cord that will not be cut by rough edges. Available in 30 foot spools or economical 100 foot spools.

Stock #	Gauge	Spool Size	Strands	
BDC-703.12	.012", Fine	30'	3	\$2.40
BDC-703.18	.018", Medium	30'	7	\$2.90
BDC-703.22	.022", Heavy	30'	7	\$3.20
BDC-710.12	.012", Fine	100'	3	\$5.55
BDC-710.18	.018", Medium	100'	7	\$7.05
BDC-710.22	.022", Heavy	100'	7	\$7.20

B. GRIFFIN JEWELRY WIRE

Now from Griffin Company of Germany, 19 and 49 strand ultra flexible Jewelry Wire for jewelry design. Strong and durable, yet soft to the touch. This product is free of any tension so it exhibits no corkscrew effect. Jewelry Wire is easily knottable, kink and stretch resistant.

Stock #	Size	Length	Strands	
BDC-719.10	.010"	30 ft.	19	\$9.50
BDC-719.12	.012"	30 ft.	19	\$8.70
BDC-719.14	.014"	30 ft.	19	\$7.60
BDC-719.18	.018"	30 ft.	19	\$7.60
BDC-719.21	.021"	30 ft.	19	\$8.70
BDC-719.24	.024"	30 ft.	19	\$8.55
BDC-749.14	.014"	30 ft.	49	\$15.95
BDC-749.18	.018"	30 ft.	49	\$14.95
BDC-749.24	.024"	30 ft.	49	\$13.95

C. STAINLESS STEEL MEMORY WIRE

Bead onto this thin, tempered stainless steel wire to create chokers, bracelets, anklets and rings that make a bold bead statement. Corrosion and tarnish-resistant and, like a spring, it snaps back to its original form when expanded and released. Wire diameter is .025" and comes in 1 oz. packs.

Stock #	Size	Color	Coil Diameter	Coils per Pack	
BDC-790.10	Ring	Bright	0.75" - 0.84"	195	\$6.95
BDC-791.10	Bracelet	Bright	1.75" - 2.25"	75	\$6.95
BDC-792.10	Lg. Bracelet	Bright	2.25" - 2.63"	60	\$6.95
BDC-793.10	Necklace	Bright	3.63" - 4.00"	36	\$6.95
BDC-794.10	Lg. Necklace	Bright	4.00" - 4.50"	32	\$6.95

G-S HYPO JEWELER'S CEMENT

Precision applicator allows maximum control with this jeweler's cement. Traditionally used for plastic or glass watch crystals but also excellent for bead stringing. Just a small amount on knots will ensure they never come loose. Will not bond fingers. Non-brittle, dries clear.

Stock #	Net wt.	
D. GLU-105.00	1/3 oz. Tube	\$5.00

G-S HYPO FABRIC CEMENT

An adhesive with needle-point application which allows the precise amount to be applied to intricate textile and fabric projects. This fabric cement is ideal for textiles, beading, leather, plastic, and other arts and crafts projects. Dries clear with no mess, no waste and will not bond fingers.

Stock #	Net wt.	
E. GLU-106.00	1/3 oz. Tube	\$5.00

E-6000® ADHESIVE

E6000 is an industrial, high performance adhesive that is ideal for jewelry and beading applications. It provides a superior bond on porous and non-porous materials such as metal, plastic, glass, rubber, tile, marble, ceramic, vinyl, fabric, leather and wood. Maintains adhesive strength even when submerged under water. Abrasion resistant so may be used on high-wear surfaces. Dries clear and is paintable.

Stock #	Net wt.	
F. GLU-600.00	3.7 oz. Tube	\$5.75
GLU-600.01	1 oz. Tube	\$2.99

TRIANGULAR TRAY

Useful 3" triangular tray for scooping, counting and putting beads and other small objects into containers. Sold per pack of 12, and made of aluminum, you will find many uses for this type of tray. Sides are slanted for ease of use and trays nest for storage.

Stock #		
A. TRA-125.00		\$2.95

BEAD SCOOP

Another EURO TOOL exclusive, this large scoop makes counting and sorting beads easy. One end is flat for scooping beads, the other long and thin for dispensing beads one at a time. Bead scoop is 6" long, flat lip is 2 1/2". Made of nickel-plated brass.

Stock #		
B. DIA-260.00		\$5.85

BEAD/STONE SCOOP

The most efficient scoop yet made, this EURO TOOL exclusive can scoop beads of all sizes, then with a twist of the wrist one can pour them into bottles or boxes or onto beading trays. This scoop can be used right or left-handed. Made of copper with heavy nickel plating. Measures 6 1/2" long.

Stock #		
C. DIA-262.00		\$6.95

BEAD SHOVELS

Our chrome-plated shovel, with a handy loop handle, is excellent for handling beads, pearls and other stones. In addition, the smallest of shovels, only 1" x 1 1/4", is just perfect for seed beads or melee stones. Especially handy when putting beads into small bags. Fits into compartment boxes and other bead storage containers.

Stock #	Description	Size	
D. DIA-252.00	Bead Shovel w/ Loop Handle	1 1/2" x 2 1/4"	\$2.35
E. DIA-254.00	Mini Bead Shovel	1" x 1 1/4"	\$2.55

BEAD SHAKERS

An excellent idea for dispensing bead crimps or seed beads. Available with 3mm or 5mm holes depending on the size you need. 3" tall clear glass so the user can easily see contents. Square, non-tip design, but beads or crimps don't spill even if they are dropped or tipped over! Just fill and shake out a few parts at a time, quickly and easily.

Stock #	Description	
BEA-100.03	3mm Hole	\$1.95
BEA-100.05	5mm Hole	\$1.95
F. BEA-100.20	Set of 2	\$3.95

SEED BEAD BOTTLE with CORK LID

Save time and patience with our Seed Bead Bottles. User can shake out a few seed beads or bead crimps without having them roll all over. Only a few come out at a time; and these small, 2" clear bottles are an excellent way to store, as well as to display and ship small articles. Each comes with a cork and is made of high quality, clear glass. Bottles are packaged in master boxes of 50 pieces per box.

Stock #		
G. PKG-200.00		\$0.50

WOOD BOTTLE TRAY

Our wood storage tray is the best way to store beads in bottles. The soft foam holds 20 of our seed bead bottles securely as the the holes in the foam are slightly smaller than the diameter of the bottles, so holds the bottles in place. Trays measure 7 1/4" x 5 1/4" x 1" and can be stacked or carried.

Stock #	Description	
PKG-210.00	Wood Bottle Tray	\$10.95
H. PKG-210.20	Bottle Tray with 20 Bead Bottles	\$19.95



Small enough to fit into bead storage boxes.



**JEWELRY SHIELD™**

The well-known product that shields sensitive skin from jewelry irritation is now available exclusively from EURO TOOL. Who needs Jewelry Shield? One in four people have an allergy to alloys present in costume and fine jewelry, glasses, watches, even clasps and snaps found on clothing. They suffer itching and skin irritation. Even more people react adversely to metals: their skin turns black, green or suffers from an itchy rash.

How does Jewelry Shield work? Brushing transparent Jewelry Shield onto jewelry and metal accessories creates an invisible shield protecting sensitive and allergy-prone skin.

Thanks to Jewelry Shield, you can now wear your jewelry without allergic reactions. Jewelry Shield's specially patented formula lasts much longer than any other product or remedy available. One application lasts three months, longer than competing products or even clear nail polish.

Stock #	Net wt.	
JWL-180.00	1/2 oz. Bottle, Carded	\$5.99
JWL-182.00	12pc Display	\$69.95



A



B

NATURAL BEESWAX

100% natural beeswax supplied in a convenient 1 oz. push-up applicator tube, which makes this wax easier to use, store and less messy. Our beeswax is excellent for picking up small stones, transferring patterns or to use with bead cord. Unbleached beeswax is less oily than more conventional bleached waxes, leaving little residue.

Stock #	Net wt.	
A. WAX-100.00	1 oz.	\$6.25

BEESWAX

Convenient 1 oz. bar of beeswax is used for thread conditioning to strengthen and straighten. Prevents ends from fraying by binding the thread fibers together.

Stock #	Net wt.	
B. WAX-120.00	1 oz. Bar	\$1.65



E



C

D

STACKABLE ROUND CONTAINERS

Space saving convenient trays for storing small parts, beads, stones or other small objects. Each tray has a threaded bottom that securely screws to the tray below it allowing access to any tray at any level. See-thru plastic with two sizes available.

Stock #	Description	Size	
C. TRA-105.00	Set of 5	2" Diameter	\$2.50
D. TRA-107.00	Set of 7	1 1/4" Diameter	\$1.75

New!

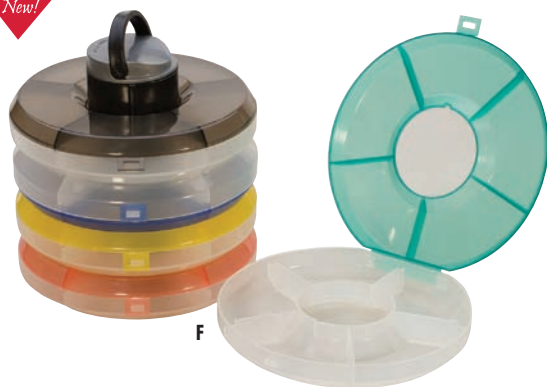

F

ULTIMATE SQUARE STACKER

The Ultimate Square Stackers have five layers with 8 compartments per layer, to hold 40 different items - beads, supplies, notions, jewelry, fly tying components, the list goes on and on! Each layer locks over the center cylinder - that serves well as a tool storage - all held together snugly with twist lock latch. Made from durable polypropylene with positive lock closing snap. Very handy for toting all the items you need for your next project!

Stock #	Size	
E. TRA-145.05	7" x 7" x 6 1/2"	\$14.99

ROUND STACKABLE TRAY

Five round trays stacked over a center locking cylinder for efficient organization. Each 6" round tray has five compartments and is color coded for easy identification. The center cylinder is 6" tall for extra storage of your tools and supplies.

Stock #	Size	
F. TRA-142.05	6" x 6"	\$8.95

MINIATURE POCKET PLIERS

Especially handy for bead stringers on the go! Cute to look at, but extremely functional. Working head is constructed from the same size blanks as larger pliers. Three piece handy "Go Anywhere" set includes chain, flat and round nose pliers.

Stock #	Description	Length	
G. PLR-430.90	3pc Set in Pouch	3" (75mm)	\$10.95

See our full line of pliers starting on page 129.



New!

TIDY TRAYS

Craft/bead tray with funnel on the end for putting loose beads easily back into original containers. Allows you to sort beads with no worry about putting them back. Also excellent for any loose craft media to control mess and save time. Plug for funnel included.



Stock #	Description	Size	
A. TRA-128.00	Tidy Tray	6" x 10" x 1"	\$4.99
B. TRA-128.50	Large Tidy Tray	10" x 16" x 1"	\$9.99
TRA-128.98	Combo Pack - 1 each small and large		\$13.99



FUNNEL TRAY

Functional low cost funnel tray ideal for beads, powders, art materials, and more. Open funnel makes it easier to clean powders from funnel. Tapered sides permits stacking; 18 pieces will fit on a 9" hook. Self-hanging tab is molded as part of the tray; consumer can easily remove or hang.

Stock #	Size	
C. TRA-129.00	7 3/4" x 6" x 1/2"	\$2.59



"EASY OUT" COMPARTMENT TRAYS

We are so excited about these trays with "Easy Out" feature because there is nothing like it in the industry! The front edge of each compartment is rounded so beads, stones or findings can be retrieved easily. Each tray features a slide lid which cannot flip open if dropped. Excellent trays for anything you want to store.

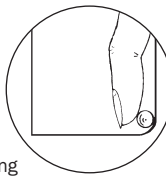

"Easy Out" feature makes bead retrieval a snap!

Stock #	No. of Compartments	Size	
D. PKG-314.00	24	5" x 7 3/4" x 7/8"	\$6.65
E. PKG-315.00	18	6 3/4" x 10 1/2" x 1 5/8"	\$7.96

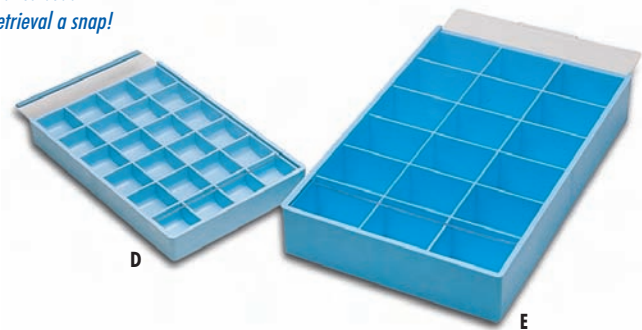

COMPARTMENT TRAYS with SLIDING LIDS

Organize a wide variety of parts and small objects with these handy plastic trays. The slide lid allows for smooth opening and closing operation to keep parts in place.

Stock #	No. of Compartments	Size	
F. PKG-305.00	7	2 1/8" x 3 3/8" x 1/2"	\$1.30
G. PKG-310.00	18	3 3/4" x 7 1/2" x 3/4"	\$5.60

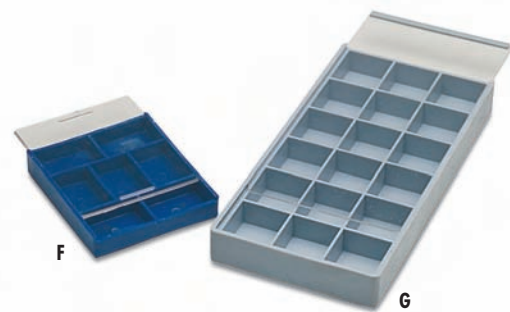

ROUND COMPARTMENT TRAYS

Handy trays with compartments have rotating lids which enable the user to open one compartment at a time. Keeps beads, findings, or other small items from spilling or mixing, but within sight. Our extra deep revolving trays allow for bulkier findings and other parts.

Stock #	No. of Compartments	Size	
H. TRA-178.00	20	7 1/2" x 1 1/2"	\$6.65
I. TRA-180.00	12	3 1/2" x 3/8"	\$3.25
J. TRA-177.00	10 Extra Deep	6 1/8" x 1"	\$8.95
K. TRA-181.00	12 Extra Deep	3 1/4" x 5/8"	\$3.45

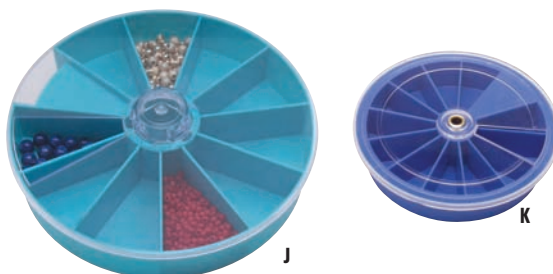



STOW 'N' GO ORGANIZER

A perfect organizer for beads, findings, parts and many other small craft items. Each organizer comes complete with six storage containers with tethered lids in clear plastic for easy viewing. Containers are securely held, but easily pulled out with a push of the finger. This versatile organizer can be mounted on a wall, cabinet, or edge of a work table. Also great portable storage as it is small enough to fit in a craft bag and sets upright on any work table.

Stock #	Description	
A. TRA-136.06	Stow 'n' Go Organizer	\$6.99

Replacement Storage Containers (fits Stow and Go and Carousel organizers) – sold per pack.

Stock #	Description	Units per pack	
B. TRA-130.00	Standard, 2 1/2" x 7/8"	6/Pack	\$2.99
TRA-130.02	Standard with tethered lids	6/Pack	\$3.99
TRA-130.01	Standard Mini, 2 1/2" x 1/2"	12/Pack	\$4.49

SINGLE CAROUSEL

Single carousel organizer securely holds 12 storage containers with a tray in the middle for miscellaneous tools and supplies. Can be stacked 5 high for maximum storage with minimum space requirements. Replacement containers sold above.

Stock #	
C. TRA-138.00	\$7.99

DELUXE CAROUSEL ORGANIZER

Great organizer for small items, includes 5 trays with 60 clear 2 1/2" x 7/8" cups, with tethered lids. This deluxe carousel will hold loads of items clearly visible and right at your fingertips! The Deluxe Carousel is mounted on a turntable and when it is used on a table or desk top it only takes a 10" x 10" space to hold over 60 items. Made of tough ABS plastic for years of busy service. Cups are clear, durable polypropylene. Comes fully assembled. Replacement containers sold above.

Stock #	
D. TRA-138.50	\$31.95

PLASTIC STORAGE CONTAINERS

This is a must have for anyone who is or needs to be organized. 28 multi-sized stacked screw-together plastic storage containers with lids. This is a great way to see all your small objects, beads and findings in one place. All this nicely kept in a clear container with secure lid.

Stock #	Description	Size	
E. PKG-325.28	28 in 1, with snap lid	10" x 4" x 1 3/4"	\$11.95

Keep small objects in place with this handy organizer. Twenty-four 1 1/4" round containers with screw-on lids are ideal for organizing beads, gems, findings or other small objects. See-thru container keeps everything together with a secure lid.

Stock #	Description	Size	
F. PKG-325.24	24 in 1	9" x 6" x 3/4"	\$11.95

Thirty 1" clear round containers in a handy and convenient clear storage box. Each individual container has a screw on lid to hold findings, beads or other small objects. Lid stays tight for protection.

Stock #	Description	Size	
G. PKG-325.30	30 in 1	6" x 5" x 1"	\$12.45

"EASY OUT" VERSATILE ORGANIZER

Looking for convenience and versatility – this is it. 20 'easy out' large compartments with removable dividers make this plastic organizer great for beads, findings, even tools and supplies. Need more room? It's as easy as taking out a divider. The rounded inside corners make retrieval of small items easy.

Stock #	Description	Size	
H. PKG-324.00	Scoop Compartment Plastic Organizer	14" x 9" x 2"	\$7.95

TRANSLUCENT UTILITY TOOL BOX

New!

Easily identify the contents with this see-thru high impact plastic utility tool box. Lightweight yet sturdy with easy open front latch to reveal two rows of trays; top tray with adjustable compartments for storage of findings, tools and small parts and a bottom compartment to hold larger items.

Stock #	Size	
PKG-320.70	13¼" W x 7½" L x 6" H	\$15.95



Tools not included.



New!

Tools not included.

BENCH TOP ORGANIZERS AND STAND

Fits perfectly on the back of a bench or on a work table. Contains space for findings, tools, accessories and organizes it all. Four draws are included for stow away items. A great compliment to any work area.

Stock #	Size	Weight	
HOL-230.05	18" L x 5" W x 3½" H	3.5 lbs.	\$34.95

BEADER'S WORKSTATION

Every beader can use the Bearer's WorkStation. Great for classes or use at home because every beader needs a place to store tools, bead cord, etc. Get organized and work easier, faster and enjoy the job! The WorkStation has two shelves for storing beads, wire or anything else that one needs close at hand. The lower shelf even has a ruler attached for easy measurement! The top shelf features ten hooks for hanging carded cord, but the dowels at the top are the best feature of all. Store pliers, cutters, scissors, shears, tweezers and more right at arm's length for easy access. Made entirely of wood, the user can put additional hooks on the sides for extra storage. Each comes individually boxed with instructions and takes only a screwdriver and five minutes to assemble. Designed and manufactured exclusively by EURO TOOL.

Stock #	Size	Weight	
HOL-225.00	22" L x 6¾" W x 15" H	6.5 lbs.	\$39.95



Tools not included.



Tools not included.

SHELFMATE "OFF THE BENCH" TOOL HOLDER

Keep your tools handy and organized, while giving yourself more workspace. Store pliers, shears and other tools so they'll be within easy reach. Burs, files, gauges - ShelfMate is ready to use and saves time. Your time is valuable - save some with ShelfMate. Designed and manufactured exclusively by EURO TOOL. Easy assembly, instructions included.

Stock #	Size	Weight	
HOL-220.00	35" L x 7¼" W x 17" H	11 lbs.	\$55.95

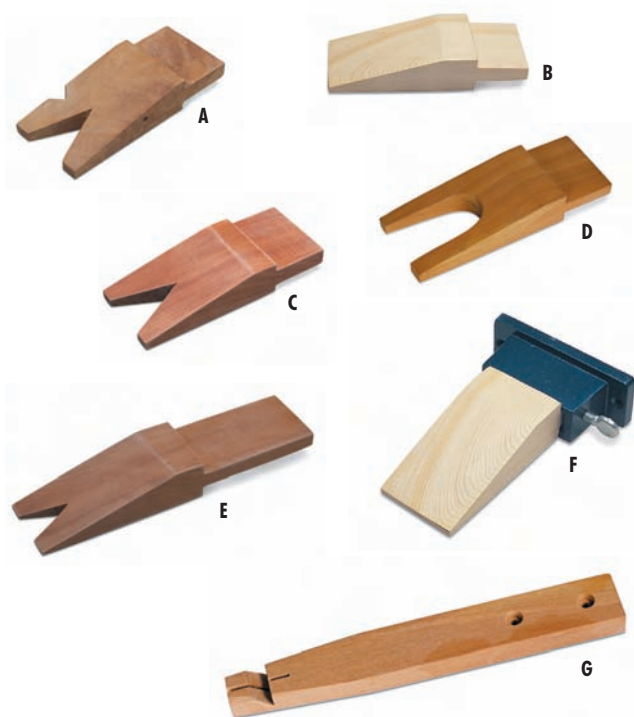

BENCH PINS

A necessary bench accessory, bench pins are made of fine hardwoods to fit slots in work benches. For use in your workbench slots or order as replacements for our bench tools as indicated.

Stock #	Description	Replacement Pin For:	
A. BPN-102.08	5 1/4" x 2 1/4" w/ 2 V-Slots		\$5.75
B. BPN-103.02	5 1/4" x 2 1/4"	BPN-103.00	\$2.20
C. BPN-103.08	5 1/4" x 2 1/4" w/ V-Slot	BPN-103.00	\$2.45
D. BPN-106.10	6 1/4" x 2 3/8" w/ cutout		\$3.96
BPN-107.10	7" x 2 3/4" w/ cutout	RCL-507.02	\$4.15
BPN-122.02	7" x 1 3/4"	BPN-122.00	\$3.50
E. BPN-122.08	7" x 1 3/4" w/ V-Slot	BPN-122.00	\$3.95

BENCH PIN with HOLDER

The holder easily screws onto the edge of a workbench and has a thumb screw that holds the wooden pin tightly.

Stock #	Description	
F. BPN-103.00	Bench Pin in Holder	\$7.95
BPN-103.02	Replacement Bench Pin – 5 1/4" x 2 1/4"	\$2.20



WOODEN RING CUTTING JIG

Our Wooden Ring Cutting Jig is economical and handy. Just 5 5/8" long it fits onto most any bench or table. Made of hardwood, this wood bench pin for rings will not scratch precious metals and assures a straight, accurate cut every time.

Stock #	
G. BPN-110.00	\$1.85

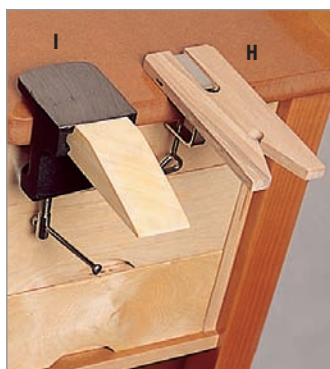

DELUXE V-SLOT BENCH PIN and CLAMP

Indispensable to any workbench for sawing and working on various materials. Ours is quality hardwood with a deluxe clamp, made in Germany. Clamps easily onto bench edge up to 1 3/4" thick.

Stock #	Description	
H. BPN-105.00	V-Slot Bench Pin and Clamp	\$7.30
BPN-105.10	V-Slot Bench Pin	\$4.20
BPN-105.20	Clamp Only	\$3.15

BENCH PIN and ANVIL

It clamps onto any bench up to 2" thick and offers the combination of a milled, smooth anvil with replaceable wooden pin.

Stock #	Description	
I. BPN-122.00	Bench Pin and Anvil	\$13.95
BPN-122.02	Replacement Bench Pin – 7" x 1 3/4"	\$3.50

SPACE SAVER BENCH APRON

Another EURO TOOL invention to save space on the bench and provide the jeweler with storage at arms length. This "Bench Apron" holds 38 tools and has pockets for pliers, tweezers, needle files and other small items, plus loops for hammers or large shears. Plier pockets allow the head to show for easy retrieval. Made of a sturdy canvas with PVC backing, the Bench Apron is suspended from a 3/8" rod which is attached to the bench by a bracket. The telescopic rod allows the Bench Apron to be pushed back when the bench is not in use. This is a great way to organize and get tools off the working surface of your bench. The Bench Apron measures 18" wide by 23" high, and comes packed individually with rod, bracket and four screws. It attaches directly to the leg of any bench and takes about five minutes to install. Could have one on each side!

Stock #	
J. BEN-310.00	\$24.95

EXCLUSIVE

Telescopes to utilize precious space.



JUMBO ANVIL

Jumbo anvil provides the user with a large $1\frac{3}{4}$ " x $3\frac{1}{2}$ " (45mm x 90mm) flat surface for pounding. We engineered this anvil to be well balanced, so with a heavy cast iron base which is $3\frac{1}{2}$ " (90mm) in diameter, it will not tilt or bounce. Made of highly polished tool steel. The horn is $1\frac{1}{2}$ " (40mm) long and tapers from $\frac{5}{8}$ " to $\frac{3}{16}$ " (16mm to 5.2mm). A EURO TOOL exclusive.

Stock #	Size	Weight	
A. ANV-230.00	4"	5 $\frac{1}{4}$ lbs.	\$32.95

LARGE DOUBLE-HORN ANVIL

A larger version of our excellent bench anvil, this model is about three times the weight. At $5\frac{1}{4}$ " tall and $7\frac{3}{4}$ " from tip-to-tip, the user is offered an anvil for a greater variety of tasks. Its highly polished horn and top surface, has a $5\frac{1}{8}$ " diameter base that is great for stability.

Stock #	Size	Weight	
B. ANV-222.00	5 $\frac{1}{4}$ " x 7 $\frac{3}{4}$ "	4 $\frac{1}{4}$ lbs.	\$34.95

DOUBLE-HORN ANVIL with ROUND BASE

Round base bench anvil has one flat and one round horn on cast steel base.

Stock #	Size	Weight	
C. ANV-220.00	2 $\frac{3}{4}$ " x 4 $\frac{3}{8}$ "	1 $\frac{3}{4}$ lbs.	\$18.95

HORN ANVILS

Made of cast steel, larger anvils are excellent for a variety of uses because of their weight. They make great bench blocks for shaping metal. Good for applications where lower cost is essential.

Stock #	Size	Weight	
D. ANV-550.00	5 $\frac{1}{4}$ " x 2 $\frac{1}{2}$ " x 2 $\frac{1}{4}$ "	1 $\frac{3}{4}$ lbs.	\$9.95
E. ANV-555.00	6 $\frac{1}{2}$ " x 3 $\frac{3}{4}$ " x 2 $\frac{1}{4}$ "	3 $\frac{3}{4}$ lbs.	\$15.95

DOUBLE-HORN ANVILS

Made for precision work, our miniature machined horn anvils are case hardened steel. Traditional models which have remained popular for years.

Stock #	Description	Size	Weight	
F. ANV-200.00	European Model	1 $\frac{1}{4}$ " x 5 $\frac{1}{4}$ "	1 $\frac{1}{4}$ lbs.	\$26.95
ANV-205.00	Economy Model	1 $\frac{1}{4}$ " x 4 $\frac{1}{2}$ "	1 lb.	\$19.85

HEX ANVIL

Used as a base for riveting, drilling and staking small parts, our hex anvil is case hardened and well polished for long life. Each anvil features 15 holes from $\frac{3}{64}$ " to $\frac{1}{4}$ " (1.2mm to 6.4mm) and five slots.

Stock #	Size	
G. ANV-170.00	1 $\frac{5}{8}$ " x $\frac{3}{4}$ "	\$10.95

"HOCKEY PUCK"

This handy device is terrific for removing pins and doing other work on watches and watch straps, where a firm but soft pad is needed. Made of black Neoprene plastic, this handy tool is practically indestructible and priced right. It is a handy accessory on any workbench, and may be used for light hammering as well.

Stock #	Size	
H. HOL-180.00	1 $\frac{5}{16}$ " x $\frac{3}{8}$ "	\$4.95

BENCH FILING BLOCK

Rubber block in cast iron clamp. Great for all types of filing and detail work. Screws securely onto edge of bench.

Stock #	Size	Weight	
I. BPN-130.00	5" x 2 $\frac{1}{4}$ "	1 $\frac{1}{4}$ lbs.	\$8.95

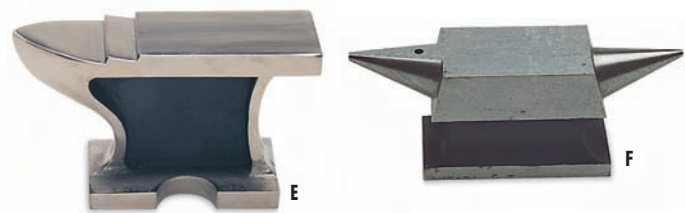

See our Bench Blocks
on page 109.

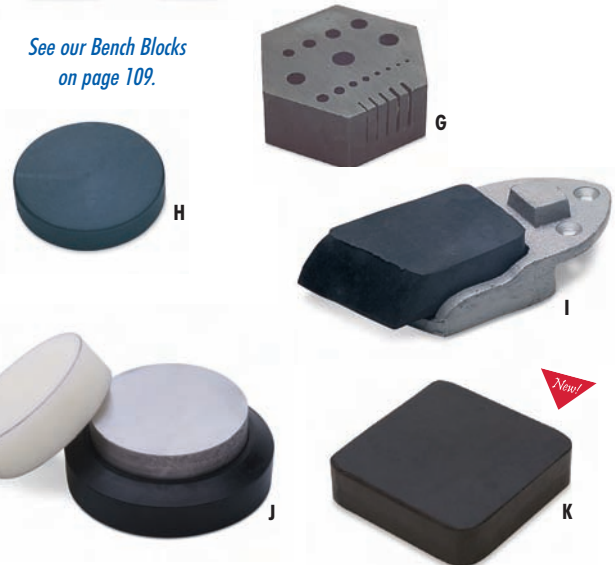

BENCH BLOCK HELPER with STEEL and NYLON BLOCKS

This three piece set includes a thick vulcanized firm rubber base which absorbs shock, plus a solid steel block which is $\frac{5}{8}$ " (16mm) thick and 3" (75mm) in diameter. The third piece is a sturdy nylon block the same size that fits into the rubber base for lighter, more delicate work. This is a well made set, and allows one to hammer without creating excess noise and vibration at the bench.

Stock #	Weight	
J. DAP-500.30	2 $\frac{1}{2}$ lbs.	\$28.95

RUBBER BLOCK

This rubber block is extremely handy on the bench, for filing, hammering, and other uses. Made of a tough, firm, vulcanized rubber measuring 4" x 4" x 1" to give the user an excellent surface. It enables one to remove dents and straighten metals without the fear of scratching or distorting, and can be used to secure parts for filing as well.

Stock #		
K. BEN-404.00		\$5.95



EURO TOOL®
original

Work smart with the
SmartVise for sawing or
drilling of thin materials.

SMARTVISE

Made of heavy spring steel with leather lined jaws, the Smartvise holds flat stock, coins and other materials firmly for accurate sawing. Lever allows the user to change directions quickly and effortlessly. Fits onto bench or table with clamp, or can be permanently attached to table with screws.

Stock #	Description	
A. VIS-100.00	Smartvise w/ Clamp	\$49.95

BENCH PIN SAW VISE

The Bench Pin Saw Vise is the perfect tool for holding metal, wood or plastic for easy sawing. A necessity for the jeweler's bench as well as for the hobbyist or craft person. Fits in standard bench slot or clamps on table. Powerful spring and non-slip jaws grip metal from 32 to 4 gauge. Quick release and self-adjusting.

Stock #	Description	
B. BPN-123.00		\$15.95

MINI BENCH VISES

These are the smallest vices we've seen! Two miniature vices, one has a clamp and the other screws permanently onto a bench or table. Both have small, one-inch jaws for precision work. Both are cast iron for durability with heavy enamel coating.

Stock #	Description	
C. VIS-214.10	1" Clamp-type	\$6.95
D. VIS-215.10	1" Bench-type	\$6.65

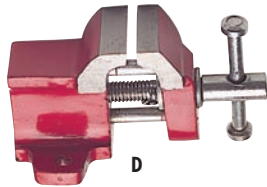
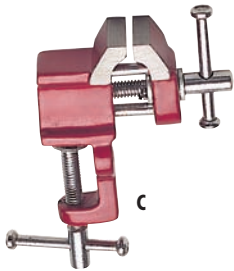

REVOLVING MINI BENCH VISES

A vise that is convenient because it revolves. Jaws are 1 1/4" (30mm) wide. Finish is a nice gray. Drop-forged with smooth jaws for delicate work on soft metals.

Stock #	Description	
E. VIS-310.00	1 1/4" Bench-type	\$15.95
F. VIS-311.00	1 1/4" Clamp-type	\$16.95

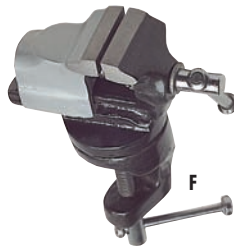

BENCH VISES

This vise offers a choice of clamping or screwing onto the bench. An excellent value and a necessity for every bench.

Stock #	Description	
G. VIS-204.00	1 1/2" Jaws	\$9.45
VIS-204.20	2" Jaws	\$9.95

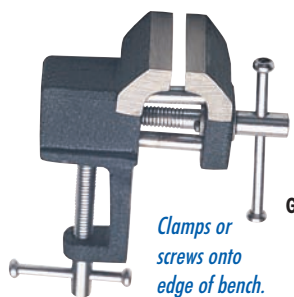

Clamps or
screws onto
edge of bench.

TABLETOP 3" SWIVEL VISE

This tabletop vise is economical, but functional. With 3" jaws lined with tough rubber, it will not scratch precious metal. The clamp has a wide enough opening to fit any bench or table. The ball and socket configuration allows the jaws to be tilted and rotate 360°, but holds jaws firmly in place at any angle. Fits any bench up to 2 1/8" thick.

Stock #	Description	
H. VIS-350.00		\$18.95

GERMAN HAND VISE

Small hand vise with wing nut has serrated, spring action jaws and a hollow handle through which wire can pass. Made in Germany of high grade tool steel. Length 4 1/2" with a 5/8" jaw width.

Stock #	Description	
I. VIS-510.00		\$24.95



PRECISION HAND VISE

This precision vise has brass jaws which have a very small groove both horizontally and vertically allowing you to hold the smallest of items when working. With a maximum jaw opening of 1/2", the vise holds work at a uniform height and distance without messy shellac. 6 1/2" overall length with a comfortable hard plastic handle.

Stock #	Description	
J. HOL-171.00		\$12.99



MITER CUTTING VISE

This Swiss-style miter vise, made of hardened steel, is used for holding wire and sheet up to 11mm wide at both 45° and 90°. A stop bar is included to perform consistent cuts repeatedly.

Stock #		
A. VIS-550.00		\$61.95

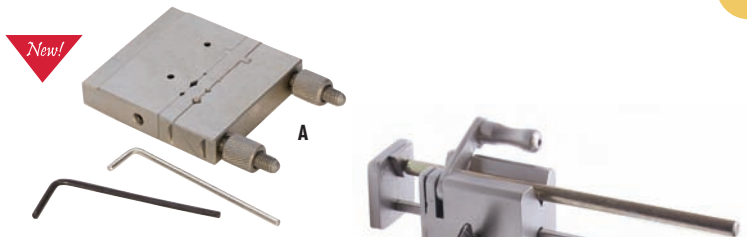

TUBE CUTTING JIG

This handy jig for cutting tubes may be hand held or secured in a regular bench vise. The thumb lever secures the tube and the groove in one side of the head assures a straight cut every time. Made of tool steel, the handle is PVC coated.

Stock #	Length	
B. HOL-108.00	5 1/2" (140mm)	\$39.95

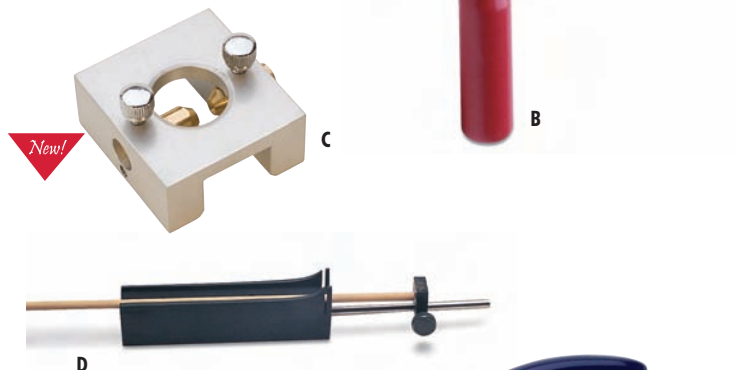

PEARL/BEAD DRILLING VISE

Bead and pearl drilling is made easy with this clever vise. Two brass cupped jaws hold the stone securely and lined up perfectly centered to allow drilling from both sides without breaking or cracking. The hole is large enough to accept a 1mm drill. Use our High Speed Twist Drills (pg. 79) with this vise.



Stock #		
C. HOL-178.00		\$39.95

TUBE CUTTING HOLDER

This tube holder can be attached to the bench or held by a bench vise. Slots at the end assure straight cutting and the guide can be set for multiple cuts when doing production work.

Stock #		
D. HOL-110.00		\$36.95



TUBE HOLDING PLIERS

Tube Holding Pliers are made to hold tubing gently but firmly when cutting, filing or doing other operations. Nylon jaws are designed to hold virtually every size tube and will not scratch. Jaws may be replaced.



Stock #	Description	Length	
E. PLR-848.00	Tube Holding Pliers	6 1/2" (165mm)	\$24.99
PLR-848.05	Replacement Jaws (pr)		\$4.95



TUBE CUTTING PLIERS

Tube Cutting Pliers make it easy for the user to hold tubing or small rods while sawing. This version of the duck billed pliers features a narrow groove down the center of the jaws for the sawblade to follow, making it quick and simple. Pliers will hold tubing from 2.0 up to 10mm outside diameter.



Stock #	Length	
F. PLR-833.00	7" (175mm)	\$26.95



Use a sawblade with our Tube Cutting Plier to quickly and easily cut tubing!

THIRD HANDS

Handy work holders feature a tweezer or clips mounted on a weighted base to hold items stable and secure in any position while soldering. Enables user to have both hands free while working. Offered in several styles including: single third hands with 6 1/2" or 4 1/2" tweezers or secure alligator clips on double third hands with or without magnifier.

Stock #	Description	
G. HOL-162.00	Double Third Hand with Clips	\$11.45
H. HOL-163.00	Double Third Hand with Clips and Magnifier	\$5.95
I. HOL-164.00	Basic Single Third Hand with 4 1/2" Tweezer	\$5.95
J. HOL-165.00	Single Third Hand with 6 1/2" Pointed Tweezer	\$8.95
HOL-165.50	Single Third Hand with 6 1/2" Blunt Tweezer	\$7.95
HOL-162.01	Clips (pair)	\$3.75
HOL-165.01	Third Hand Base Only	\$7.45





WOOD TOP PIN VISE

Offers the user a multi-chuck pin vise that is more comfortable to use than conventional hex head vises. The rounded head fits comfortably into the palm of one's hand making it much easier to drill, ream or twist. Measures 4" long with two, double-ended chucks from zero to 3.3mm capacity.

Stock #	Length	Capacity	
A. PIN-224.00	4"	0 – 3mm	\$4.50

REVERSIBLE CHUCK PIN VISE

Nickel pin vise has two tempered steel reversible chucks and four openings. Length is 4 1/2". Capacity of 0 to 3.0mm.

Stock #	Length	Capacity	
B. PIN-219.00	4 1/2"	0 – 3.0mm	\$4.50

DOUBLE ENDED PIN VISE

Known as "Swiss style," this pin vise features two chucks. Capacity of 0 to 2.5mm (0 – .10"). Length is 4 1/2".

Stock #	Length	Capacity	
C. PIN-218.00	4 1/2"	0 – 2.5mm	\$4.00

MINI PIN VISE

Pin Vise is only 3 1/2" long with a chuck which goes from 0 to 0.8mm (0 – .032"). Blackened tool steel with knurled handle. This may be the best pin vise value around.

Stock #	Length	Capacity	
D. PIN-212.00	3 1/2"	0 – 0.8mm	\$3.10

SWIVEL-HEAD PIN VISE

Swivel-head pin vise for drilling, tapping or use as a screwdriver. Two double-ended chucks. Capacity of 0 to 3.3mm (0 – .125").

Stock #	Length	Capacity	
E. PIN-220.00	3 1/2"	0 – 3.3mm	\$4.50

SLIDING PIN VISE

Single-end pin vise has knurled slide for easy one-hand operation. Capacity of 0 to 0.8mm (0 – .032"). Length is 4 1/2".

Stock #	Length	Capacity	
F. PIN-221.00	4 1/2"	0 – 0.8mm	\$4.55

ALUMINUM PIN VISE

Aluminum pin vise/handle features a 1/8" (3mm) chuck for larger applications. The handle is 5" long and can be used with needle files and various other hand tools.

Stock #	Length	Capacity	
G. PIN-222.00	5"	0 – 3.0mm	\$2.25

FOUR PIECE PIN VISE SET

Hardened steel pin vises ensure long life! Set of four with size range of 0" to 3/16" (4.75mm). Comes in a handy plastic pouch.

Stock #	Description	Capacity	
H. PIN-240.00	Set of 4	0 – 4.75mm	\$9.95

Hold drills and more...

Pin Vises hold a variety of tools for precision work:

- Use as a hand drill with small twist drills.
- Hold wire, stock or tubing for filing.
- Accepts broken sawblades for wax filing.
- Use as a screwdriver with small screwdriver blades.
- Holds burs, files, reamers and more!

UNIVERSAL WORK HOLDER

The four movable pins accommodate large and small items during engraving or repair. Jaws screw in and out to securely hold items in place. Set of four replacement pins also available.

Stock #	Description	
A. HOL-166.00	Holder with Four Pins	\$18.95
HOL-166.04	Set of 4 Replacement Pins	\$2.95

BRACELET HOLDER

This bracelet holder is the only tool which will adequately hold "tennis" bracelets without using messy glues. Six allen screws allow the user to evenly hold tennis bracelets when mounting multiple stones. Saves the user time and money.

Stock #	
B. HOL-112.00	\$24.95

HEMOSTAT FORCEPS

Handy, plier-like tools made originally for medical purposes work perfectly as clamps for small articles. Made of stainless steel, the box-joint construction and serrated jaws provide firm holding. All have a three-position locking device. Other sizes are available upon request.



Stock #	Description	Handles	
C. HEM-885.10	5" Straight	PVC Grips	\$6.50
D. HEM-885.20	5" Curved	PVC Grips	\$6.50
HEM-886.10	6" Straight	PVC Grips	\$6.75
HEM-886.20	6" Curved	PVC Grips	\$6.75

Stock #	Description	Handles	
E. HEM-895.10	5" Straight	Uncoated	\$4.95
F. HEM-895.20	5" Curved	Uncoated	\$4.95
HEM-896.10	6" Straight	Uncoated	\$5.25
HEM-896.20	6" Curved	Uncoated	\$5.25

PLASTISTAT

Our polypropylene hemostat has a variety of applications. Impervious to acid, which means it can be used for pickling, it will not stick to glues of any kind, making it great for clamping jewelry, ceramics, wood and many other materials. The serrated tips give the Plastistat super holding power without scratching, and it may be filed to the shape desired. Loop handles also allow it to be suspended into your ultrasonic.

Stock #	Length	
G. HEM-300.00	4 7/8"	\$1.00

MATHIEU CLAMPS

Mathieu clamps, without serration, offer the user the perfect way to hold many objects but are especially good for holding beading cord or wire while stringing. Clamps are stainless steel, non-serrated, light weight and have a unique locking mechanism making them easier than regular hemostats to use. They lock when squeezed, then open when squeezed. You'll get years of service from these unique instruments.

Stock #	Length	
H. HEM-150.15	5"	\$8.95

2" SPRING CLAMP

There are a variety of uses for our new 2" spring clamps. Excellent for holding bead cord or wire when stringing. Remove the PVC tip covers to use for light soldering. Nice spring tension holds objects securely. Sold in bags of ten.

Stock #	Qty.	
I. HOL-172.02	pk/10	\$4.95

ADJUSTABLE SLIDE HOLDER

Easy-to-use sliding clamp is great for securely holding a variety of parts while working. Spring-operated with plastic posts which will not mar or scratch your piece. Maximum capacity 1 3/8" (36mm).

Stock #	
J. CWR-170.00	\$6.95

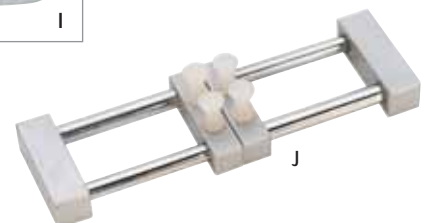



MOTORIZED HANDPIECE AND ACCESSORY KIT

Kit includes a variety of $\frac{3}{32}$ " shank instruments for cleaning, grinding, shaping, drilling, polishing, and much more. 12 piece set comes with handy wood bench storage block.

Stock #	Description	
A. HDP-375.50	Handpiece Only	\$35.95
B. HDP-375.90	Accessories Kit	\$19.95

Kit includes one each:

- #20 Red Stone Abrasive
- $\frac{3}{4}$ " Wheel Brush - Stiff
- $\frac{3}{4}$ " Wheel Brush - Medium
- Bud Felt Bob
- Knife Edge Felt Bob
- 2.3mm Cup Bur
- 1.0mm $\frac{3}{32}$ " Shank Twist Drill
- 1.5mm $\frac{3}{32}$ " Shank Twist Drill
- $\frac{1}{4}$ " End Brush - Stiff
- $\frac{3}{4}$ " Mini Brass Brush
- Cone Silicone Fine Polisher
- Knife-Edge Silicone Fine Polisher



FLEX SHAFT SYSTEM

This economical workhorse is perfect for cleaning, polishing, sanding, drilling and much more. This unit is also compatible with most jump ring systems. Includes $\frac{1}{10}$ hp motor, #30 style hand piece, foot control, flex shaft/sheath and chuck key.

Stock #	
C. HDP-150.00	\$119.95



DUAL FLEX SHAFT MOTOR HANGER

Our dual flex shaft holder features a square telescopic shaft that cannot swivel or turn inadvertently. Securely fasten the unit to any workbench using four large wood screws (not included). Adjustable height ranging from 24" to 46".

Stock #	
D. HOL-625.00	\$25.95

FLEX SHAFT MOTOR HANGERS

Telescoping hangers will extend 42" above your workbench. Height adjustments are made easily with the thumbscrew. Made with a solid mounting base or clamp and a 10" swing arm.

Stock #	Description	
E. HOL-619.00	Bench Mount Model	\$18.95
F. HOL-620.00	Bench Clamp Model	\$26.95



Use Cut Lube for cool, clean cuts and prolonged tool life.

ERGONOMIC ARM REST

Support your arm when working at a bench or tabletop. The ergonomically designed padded armrest simply slides onto a desk or bench to help alleviate arm fatigue and steady your arm when working for long periods of time.

Stock #
 A. BEN-100.00 \$27.95



SAFETY GLASSES

German-made all clear safety glasses with five point adjustable earpieces. Lenses can be adjusted horizontally to the angle you prefer. They are wrap-around and made of high-impact plastic. The lenses are distortion-free and scratch resistant. Made in Germany.

Stock #
 B. GLS-120.30 \$16.75



SAFETY GLASSES

Wrap-around safety glasses are easily removable but protect eyes with comfort. Lenses are extra clear high impact material. Earpieces are four point adjustable. Distortion-free lenses and wrap-around design assures particles can't reach the users' eyes when worn properly. Glasses feature holes for elastic strap or chain. Made in Germany.

Stock #
 C. GLS-120.24 \$10.10



SOLDERING GLASSES

#5, #7 and #10 green lens glasses are for soldering platinum. The #7 is the lens approved by the Platinum Guild, but some users prefer a slightly lighter #5 green. The #10 lens is used when casting. Glasses are black, lightweight plastic – very comfortable with adjustable earpieces and replaceable polycarbonate lenses. CE approved. You can't get better. Made in Germany.

Stock #	Description	
D. GLS-100.05	Welding Goggles #5	\$15.40
GLS-100.07	Welding Goggles #7	\$15.70
GLS-100.10	Welding Goggles #10	\$15.70
GLS-100.15	#5 Lens for GLS-100.05	\$3.60
GLS-100.17	#7 Lens for GLS-100.07	\$4.15
GLS-100.20	#10 Lens for GLS-100.10	\$4.15



SHOP APRON

Our shop apron is long lasting and of first quality 12 oz. dark blue denim. It features breast and waist pockets. One size fits all with this 28" x 36" apron.

Stock #
 E. APN-200.00 \$7.80





A



B

New!

Slightly tacking palm gives a super grip!



C

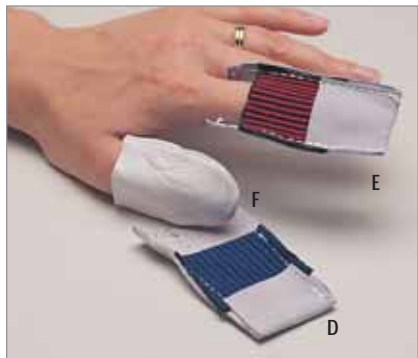

D

E

F



G



I



H

COTTON GLOVES

Cotton gloves protect jewelry, displays, silverware and optical surfaces keeping it free from fingerprints and tarnish. Sold by the dozen.

Stock #	Description	Qty.	Size	
A. GLV-190.10	Lightweight	12/bg	Small (Ladies)	\$4.95
GLV-190.20	Lightweight	12/bg	Large (Men)	\$5.25
GLV-190.30	Lightweight	12/bg	Extra Large	\$7.45
GLV-195.10	Medium Weight	12/bg	Small (Ladies)	\$9.90
GLV-195.20	Medium Weight	12/bg	Large (Men)	\$10.50
GLV-195.30	Medium Weight	12/bg	Extra Large	\$13.40

DISPOSABLE LATEX GLOVES

Our disposable latex gloves are thin but tough to protect your hands from dirt, grit and harsh chemicals. Great to keep hands clean when buffing or polishing. Made of a high grade expandable latex, our gloves are sold in an easy access carton.

Stock #	Description	Qty.	
B. GLV-200.00	Small Latex Gloves	100/bx	\$9.00
GLV-210.00	Medium Latex Gloves	100/bx	\$9.00
GLV-220.00	Large Latex Gloves	100/bx	\$9.00

SUPER GRIP GLOVES

Our Super Grip gloves offer the best in hand and finger protection. Slightly tacky palm is nitrile coated for a great grip and extra puncture resistance. The remainder is woven poly which breathes, keeping hands cool. Gloves are sold by the pair.

Stock #	Description	Qty.	
C. GLV-180.10	Small	pair	\$5.95
GLV-180.20	Medium	pair	\$5.95
GLV-180.30	Large	pair	\$5.95

FINGER GUARDS

Our leather thumb and finger guards give polishers the protection necessary to do the job right. Featuring an enclosed end and elastic to hold them in place, EURO TOOL thumb and finger guards are made of pliable leather. Sold per pack of ten.

Stock #	Description	Qty.	
D. POL-200.00	Thumb Guard w/Elastic	10/pk	\$9.50
E. POL-205.00	Finger Guard w/Elastic	10/pk	\$9.50
F. POL-208.00	Soft Leather Thumb Guard	10/pk	\$9.45

FINGER PRO

Finger Pro is the ultimate finger protection from cuts, burns and abrasions. Because Finger Pro is thin and tough, it allows the user to handle small articles much better than conventional cots or gloves. This unique tape sticks only to itself, not to your skin. Finger Pro breathes and actually enhances your grip and is easily removed when the work is done. Available in 3/4" and 1" widths, Finger Pro costs the user just pennies per application. Packaged and priced per bag.

Stock #	Description	Qty.	
G. POL-250.00	3/4" Finger Pro	16 Rolls per Bag	\$20.95
POL-255.00	1" Finger Pro	12 Rolls per Bag	\$20.95

ZAP-TRAP

Simple, yet perhaps the most effective drain trap available. The stainless steel rim and screen are heavy enough to stay put and the fine mesh catches the smallest of stones or particles. Zap-Trap fits virtually any sink drain from 1 1/8" to 2 1/2" in diameter. You'll recover your investment many times over with the Zap-Trap.

Stock #	
H. CLN-225.00	\$5.95

MAJIC DRAIN

Majic Drain is easy to clean and retrieve articles which would otherwise be lost forever. This see-thru trap saves gemstones, rings, bits of gold and other small valuables. Because the snap-off filter can be easily removed, you simply recover the lost article at that moment. Majic Drain can be easily installed and fits 1 1/2" or 1 1/4" drain pipes. Its all plastic construction means rust and corrosion are never a problem. Complete directions are on the back of each box. Easy to install and all the necessary hardware is included.

Stock #	
I. CLN-220.00	\$12.95

JETT SETT™

Jett Sett is a unique, easy-to-use fixturing compound formulated from an advanced thermoplastic and ceramic material. It is used for stone setting and engraving, as well as many other applications. Just heat it in hot water, which warms the material allowing it



to be formed in whatever manner is desired. Quick to set, non-toxic, biodegradable and versatile, it will not stick to, scratch or damage metal parts and can be resoftened and used again and again. It requires no special tools and will not chip or break even under extreme pressure or shock. Jett Sett can be formed into comfortable, customized handles for your bench tools. It will also quickly and effectively mask your parts during sandblasting or glass bead blasting operations.

Stock #	Description	
A. JET-100.00	1 lb. bag	\$36.95



Use Jett Sett to:

- Make custom file handles.
- Protect hammer heads.
- Make holding fixtures.
- Create custom, ergonomic tool handles.

And countless other possibilities!



HOT POT EXPRESS®

This 32 oz Hot Pot is perfect for use with our Jett Sett™ fixturing material. It features a non-stick surface with adjustable heat setting, from high to low, which will give the user a consistent water temperature. White in color with a removable flip-top lid for easy cleaning, the Hot Pot Express® is portable for your convenience.

Stock #		
B. CLN-582.00		\$24.95



C. 412 SLICK LUBE

412 Slick Lube is the most advanced coolant on the market today. A 100% synthetic polymer coolant, which is a unique blend of wetting agents, lubricants, and rust inhibitors. Excellent for drilling and cutting with diamond instruments. Slick Lube contains no nitrosamines, phenols, nitrates, sulphur, chlorine, phosphates, or oil. It controls dermatitis with the addition of skin conditioners. Mix 1 part Slick Lube and 10 parts water and you have the best in a water soluble lubricant.

Stock #	Description	
LUB-412.08	1/2 Pint (8 oz.)	\$5.50
LUB-412.16	Pint (16 oz.)	\$9.50
LUB-412.32	Quart (32 oz.)	\$16.80



EXCLUSIVE

D. BENCH STONES

High quality, natural Arkansas bench stones used for sharpening knives and cutting tools. Outlasts and produces a better finish than bonded or man-made abrasive stones. Ours are available in beautiful cedar boxes, mounted or unmounted. Available in two grits:

- Hard Arkansas: Fine** – for polishing and maintenance of a fine edge on knives or tools.
- True Hard: Extra Fine** – finest grade abrasive stone available for applications where an extremely fine polish is required.

Mounted Bench Stones

Stock #	Grit	Dimensions	
ABR-800.10	Hard (Fine)	4" x 2" x 1/2"	\$21.85
ABR-800.20	Hard (Fine)	6" x 2" x 1/2"	\$38.20
ABR-800.30	Hard (Fine)	8" x 2" x 1/2"	\$53.25
ABR-802.10	True Hard (Extra-Fine)	4" x 2" x 1/2"	\$44.75
ABR-802.20	True Hard (Extra-Fine)	6" x 2" x 1/2"	\$65.65

Unmounted Bench Stones

Stock #	Grit	Dimensions	
ABR-803.10	True Hard (Extra-Fine)	4" x 2" x 1/2"	\$42.50
ABR-803.20	True Hard (Extra-Fine)	6" x 2" x 1/2"	\$66.50

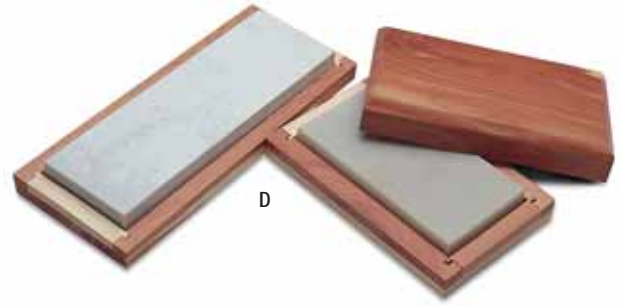



UNMOUNTED MINIATURE WHEEL BRUSHES

High-quality unmounted brushes are used for polishing with flex-shaft machines. Manufactured with the finest natural materials, the bristles will not come out during use because the hubs are highly compressed. All have 1/8" center hole. Sold by the dozen in plastic hanging bags.

Stock #	Bristle Length	Bristles	
A. BRS-300.10	3/4"	Stiff	\$3.40
B. BRS-302.10	3/4"	Medium	\$3.40
C. BRS-305.10	3/4"	Soft	\$3.45
BRS-310.10	1"	Stiff	\$4.80
BRS-312.10	1"	Medium	\$4.80
BRS-315.10	1"	Soft	\$5.30

*Unmounted mini brushes also available with 3/32" hole.

MINIATURE BRUSHES ON MANDRELS

Our quality brushes have a steel hub with 3/32" arbor for flex-shaft machines. Miniature brushes are great for cleaning and polishing hard-to-reach areas. Overall length is 1 3/4". Sold by the dozen.

Stock #	Bristle Length	Bristles	
D. BRS-400.00	3/4"	Stiff	\$4.15
E. BRS-402.00	3/4"	Medium	\$4.15
F. BRS-405.00	3/4"	Soft	\$4.50
G. BRS-460.00	3/4"	Brass Wire - Crimped	\$10.45
H. BRS-465.00	3/4"	Steel Wire - Crimped	\$11.05
BRS-410.00	1"	Stiff	\$6.00
BRS-412.00	1"	Medium	\$6.00
BRS-415.00	1"	Soft	\$6.00
BRS-470.00	1"	Brass Wire - Crimped	\$11.40
BRS-475.00	1"	Steel Wire - Crimped	\$11.80

CUP BRUSHES

Natural-bristle cup brushes are mounted on 3/32" arbors. Available in 1/2" diameter (measured at flared end), they are designed to clean crevices. Sold by the dozen.

Stock #	Dia.	Bristles	
I. BRS-420.00	1/2"	Hard	\$4.50
J. BRS-425.00	1/2"	Soft	\$4.75

END BRUSHES

End brushes fit directly into flex-shaft units for difficult cleaning jobs in tight areas. All have a 3/32" arbor and 3/8" diameter heads. Sold by the dozen.

Stock #	Bristle Length	Bristles	
K. BRS-430.00	1/4"	Stiff	\$3.70
L. BRS-435.00	1/4"	Soft	\$4.05
M. BRS-440.00	1/2"	Stiff	\$3.70
N. BRS-445.00	1/2"	Soft	\$4.05
O. BRS-450.00	1/4"	Brass Wire - Crimped	\$7.50
P. BRS-455.00	1/4"	Steel Wire - Crimped	\$7.95

MINI-TEXTURING WHEELS

Our texturing wheels are great for putting a satin finish on jewelry, stainless steel, profiled surfaces and on fine structured satinized surfaces. Sold per piece. Overall length is 1 3/4".

Stock #	Dia.	Bristles	
Q. BRS-804.00	3/4"	Stiff	\$2.20
R. BRS-806.00	3/4"	Flexible	\$2.20

METAL-HUB BRUSHES

Metal-hub brushes have nylon or lead centers and are available in black (stiff), grey (medium), white (soft) or stiff with a muslin insert. 2" diameter with a 1/8" hole.

Stock #	Bristles	Center Hole	Origin	
S. BRS-210.00	Black/Stiff	Black Nylon	England	\$2.35
T. BRS-210.05	Black/Stiff	Green Nylon	Germany	\$2.05
U. BRS-210.10	Black/Stiff	Yellow Nylon	Germany	\$2.05
V. BRS-212.00	Grey/Medium	White Nylon	England	\$2.40
W. BRS-215.00	White/Soft	White Nylon	Germany	\$2.30
X. BRS-220.00	Black/Stiff	Lead	England	\$2.40
Y. BRS-225.00	White/Soft	Lead	England	\$2.40
Z. BRS-230.00	Black/Muslin	Black Nylon	England	\$3.10

MUSLIN COMBINATION BRUSH

This 3" muslin/bristle combination wheel brush provides excellent compound retention. Bristles are Chung King and brush has a nylon center. Made in England.

Stock #	Rows	Hub	Diameter	
AA. BRS-160.00	3	1 1/2"	3"	\$4.75

GLASGOW WASHOUT BRUSHES

Four uniform rows of white bristles locked in a wood handle are great for cleaning fine jewelry, PC boards and other washing applications. Simply the most popular washout brush available. Made in Germany.

Stock #	Length	Bristles	
A. BRS-359.01	10"	Hard	\$5.60
B. BRS-359.02	10"	Medium	\$5.60
C. BRS-359.03	10"	Soft	\$5.60
D. BRS-359.04	10"	Extra Soft	\$5.95

WOOD HANDLE METAL BRUSHES

Four-row brushes made in Germany of 0.10mm crimped steel or brass wire set in a wooden handle. Excellent for cleaning or surface texturing on soft metals.

Stock #	Length	Bristles	
E. BRS-967.00	8 ⁵ / ₈ "	Steel	\$7.45
F. BRS-968.00	8 ⁵ / ₈ "	Brass	\$6.90

BONE HANDLE WASHOUT BRUSH

Four rows of natural Chung King hard bristles are set in a bone handle. Ideal for use in chemicals.

Stock #	Length	
G. BRS-965.00	6 ³ / ₄ "	\$5.85

SOFT STEEL BRUSH

Our 8" stainless steel brush with 3/4" crimped bristles offers excellent value at this price. With hardwood handle and three rows of bristles, this is the perfect brush for precious metal clay (PMC) work and other applications or small projects where a softer steel brush is needed.

Stock #	Length	
H. BRS-967.05	8"	\$3.95

FINE METAL BRUSHES

The best brass and stainless steel brushes we've ever seen because the bristles are finer than most and the handle is curved for better access. This makes them excellent for PMC and other applications where a softer bristle is preferable. The handle is laminated hardwood with three rows of fine gauge bristles. Our value metal brushes are priced right yet still softer than the normal brass and steel cleaning brushes.

Stock #	Description	Length	Bristle Length	
I. BRS-966.05	Fine Steel	7 ³ / ₄ "	7/16"	\$10.99
J. BRS-966.10	Fine Brass	7 ³ / ₄ "	7/16"	\$10.99
K. BRS-964.05	Value Steel	8"	1/2"	\$6.95
L. BRS-964.10	Value Brass	8"	1/2"	\$6.95

BENCH BRUSH

European-made horse-hair bench brush has four rows of 11/2" bristles in hardwood to assure effective cleaning.

Stock #	Length	Bristle Length	
M. BRS-969.10	10"	4 ³ / ₄ " x 1"	\$7.30

HAND BRUSH

Stiff nylon bristles set in a 11/2" x 4" block for general purpose cleaning. Surgeon-style grip handle is ideal for hands and fingernails or cleaning out investment.

Stock #		
N. BRS-962.00		\$3.30

STATICWISK™ ANTI-STATIC BRUSH

Safe and effective dust and static remover, the StaticWisk™ will provide years of use in cleaning optics, cameras, plastics, glass, watch and clock dials, and crystals. Washable StaticWisk™ is made from a blend of special soft, natural hair and a conductive fiber.

Stock #	Description	
O. BRS-972.00	3/4" (20mm) Anti-Static Brush	\$6.95
P. BRS-973.00	1 1/4" (30mm) Anti-Static Brush	\$15.95



Soft metal brushes are great for PMC work!

New!





A



B



C



D



E



F



G



H



I



1 2 3 4 5 6 7 8 9 10 11 12



J

K

UTILITY BRUSH

Quality import artist brush #1 is great for adding patinas or applying slip to join elements, make repairs or reinforcing areas. Total length 8¹/₄" , bristle length 1¹/₂".

Stock #

A. BRS-495.00

\$1.95



UTILITY/FLUXBRUSH

Natural bristle acid brushes have crimped all-metal handles. Economical, general purpose utility brush great for one-time use applications to save time and avoid messy cleanups. Suitable for acid, flux, epoxy, glue, paste, touch-ups, solvents and more. Sold in packs of twelve.

Stock #

B. BRS-980.05

Size

3³/₈" x 6"

\$1.85

EXTRA THIN FIBERGLASS SCRATCH BRUSH

Pen-shaped, spring-loaded mechanism. Measures 4³/₄" long with 1¹/₁₆" diameter fiberglass brush. Great for tight places and electronic applications. Refills are 4¹/₄" long and 12 per pack. Made in Germany.

Stock #

Description

C. BRS-290.00

Extra-Thin Fiberglass Scratch Brush

\$7.35

BRS-290.01

Refill 12/pk

\$7.95

SCRATCH BRUSHES with METAL FERRULES

Our scratch brushes with pen-shaped handles come in four different types. They are used for removing rust or corrosion in hard to reach places. The brass model is excellent for cleaning clogged burs. Offered with metal ferrules for improved durability. Refills are packaged 24 to a box. Length is 4¹/₂", refills are 1¹/₄" long. Made in Germany.

Stock #

Description

D. BRS-292.00

Steel

\$7.50

E. BRS-293.00

Nylon

\$5.95

F. BRS-294.00

Fiberglass

\$6.25

G. BRS-295.00

Brass

\$7.20

H. BRS-294.50

Economy Fiberglass (India)

\$2.95

Refill #

BRS-292.01

Steel Refill (24/bx)

\$21.15

BRS-293.01

Nylon Refill (24/bx)

\$14.25

BRS-294.01

Fiberglass Refill (24/bx)

\$14.50

BRS-295.01

Brass Refill (24/bx)

\$19.95

MOUNTED FELT BOBS

All the felt bobs in this assortment are top quality, American-made. Mounted on 3³/₃₂" mandrels. The set comes packaged in a handy, twelve-compartment box with easy reference lid for convenience in storing, using and reordering.

Stock #

Description

I. BUF-512.00

12 pc Assortment (1-12 below)

\$16.95

BUF-512.xx

Individual Felt Bobs (listed below)

\$1.39

Kit Includes one each of the following:

- | | |
|--|--|
| 1) BUF-512.01 Bud (3 ³ / ₈ " x 3 ³ / ₄ ") | 7) BUF-512.06 Inverted – small (1 ¹ / ₁₆ " x 3 ³ / ₁₆ ") |
| 2) BUF-512.02 Round (5 ¹ / ₁₆ " x 3 ³ / ₈ ") | 8) BUF-512.07 Inverted – large (7 ⁷ / ₈ " x 3 ³ / ₁₆ ") |
| 3) BUF-512.03 Cone (1 ¹ / ₄ " x 3 ³ / ₄ ") | 9) BUF-512.09 Knife – small (3 ³ / ₄ ") |
| 4) BUF-512.04 Pointed (5 ¹ / ₁₆ " x 5 ¹ / ₈ ") | 10) BUF-512.10 Knife – large (7 ⁷ / ₈ ") |
| 5) BUF-512.05 Cylinder (3 ³ / ₈ " x 5 ¹ / ₈ ") | 11) BUF-512.11 Square Wheel – small (1 ¹ / ₁₆ " x 1 ¹ / ₄ ") |
| 6) BUF-512.21 Cylinder (1 ¹ / ₄ " x 3 ³ / ₈ ") | 12) BUF-512.12 Square Wheel – large (7 ⁷ / ₈ " x 1 ¹ / ₄ ") |

MOUNTED MINI BUFFS

Mini chamois and muslin buffs are two versatile instruments for polishing. Each mounted on a 3³/₃₂" steel shank.

Stock #

Description

J. BUF-530.10

1" Chamois Buff

\$1.39

K. BUF-550.10

1" Muslin Buff

\$1.39

“BRILLIANT” BUFF

Made of 100% Long Strand Egyptian cotton, the Brilliant Buff is impregnated with the same patented chemical as our rougeless polishing cloth. This chemical agent is harmless to the environment but leaves a light residue on precious metals which inhibits tarnish. Excellent for that final buffing, then just wipe with a dry cloth and you'll see a beautiful luster. Buff has a small hole for tapered spindles.

Stock #	Size	
A. BUF-115.00	4 1/2" x 3/4" (115 x 20mm)	\$11.20

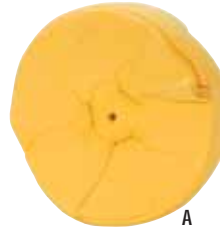

A



See our new Chamois Buff Sticks on pg. 166.

SATIN FINISH BUFFS

Our red satin buffs are non-woven abrasive wheels incorporating aluminum oxide and treated with a special resin. The gray satin buffs incorporate silicon carbide and are also treated with a special resin. The red buffs are more aggressive, giving a satin finish to gold, silver and other non-ferrous metals. Several sizes are available and all satin buffs have a 1/4" hole, perfect for tapered spindles.

Stock #	Description	Size	
B. BUF-702.07	Red, Very Fine	2 3/8" x 3/4" (60mm x 20mm)	\$7.95
BUF-704.05	Red, Very Fine	4" x 3/8" (100mm x 10mm)	\$8.25
BUF-704.07	Red, Very Fine	4" x 3/4" (100mm x 20mm)	\$9.10
C. BUF-712.07	Red, Fine	2 3/8" x 3/4" (60mm x 20mm)	\$7.95
BUF-714.05	Red, Fine	4" x 3/8" (100mm x 10mm)	\$8.25
BUF-714.07	Red, Fine	4" x 3/4" (100mm x 20mm)	\$9.10
BUF-714.10	Red, Fine	4" x 1 1/8" (100mm x 30mm)	\$12.20
D. BUF-752.07	Gray, Ultra Fine	2 3/8" x 3/4" (60mm x 20mm)	\$7.95
BUF-754.07	Gray, Ultra Fine	4" x 3/4" (100mm x 20mm)	\$9.10



B



C



D



E



F



G



H



I

FINEX MUSLIN BUFFS

Produced to exacting specifications, our Finex Muslin Buffs and Yellow Treated Buffs are the standard of the industry. Carefully manufactured of the highest quality materials, Finex Muslin Buffs are made of combed cotton for softness with a thread count of 80 x 80; they give the user better compound retention and longer life. Finex Muslin available with shellac, leather or plastic centers as well as stitched or loose. Specially treated yellow Chemkote buffs offer more aggressive performance for removing scratches.

E. COMBED FINEX MUSLIN BUFFS – STITCHED, LEATHER CENTERS

Made of very fine, soft combed muslin, stitched buffs are for use with polishing compounds to produce a final, high polish. Stitched with leather centers to add stiffness.

Stock #	Diameter	Ply	Stitch	
BUF-683.35	3"	35	3 rows	\$2.00
BUF-684.50	4"	50	3 rows	\$2.85
BUF-685.50	5"	50	3 rows	\$4.50
BUF-686.50	6"	50	4 rows	\$5.00

F. COMBED FINEX MUSLIN BUFFS – LOOSE, LEATHER CENTERS

Unstitched finex muslin buffs with combed edges, are soft and flexible. Use with polishing compounds such as rouge for final finishing. These loose buffs with leather centers are ideal for polishing contoured edges.

Stock #	Diameter	Ply	
BUF-693.35	3"	35	\$2.00
BUF-694.50	4"	50	\$2.85
BUF-694.60	4"	60	\$3.05
BUF-695.50	5"	50	\$3.75
BUF-696.50	6"	50	\$4.90

G. COMBED FINEX MUSLIN BUFFS – LOOSE, PLASTIC CENTERS

Loose Finex muslin buffs with hard plastic centers for final polishing. Extra durability without the environment concerns of lead centers.

Stock #	Diameter	Ply	
BUF-633.54	3"	54	\$3.05
BUF-634.54	4"	54	\$3.45
BUF-635.54	5"	54	\$4.60
BUF-636.54	6"	54	\$5.75

H. COMBED FINEX MUSLIN BUFFS – STITCHED, SHELLAC CENTERS

Made of very fine, soft combed muslin, these buffs are for use with polishing compounds to produce a final, high polish. Stitched with shellac centers.

Stock #	Diameter	Ply	Stitch	
BUF-653.35	3"	35	3 rows	\$1.80
BUF-654.50	4"	50	4 rows	\$2.75
BUF-655.50	5"	50	3 rows	\$4.70
BUF-656.50	6"	50	4 rows	\$5.20

I. CHEMKOTE YELLOW BUFFS

Surface scratches are easily removed with this more aggressive specially treated buff. Longer lasting with excellent compound retention. Excellent for use with tripoli or other abrasive compounds.

Stock #	Diameter	Ply	Stitch	
BUF-663.30	3"	30	3 rows	\$2.10
BUF-664.50	4"	50	3 rows	\$4.40
BUF-665.50	5"	50	3 rows	\$6.25
BUF-666.50	6"	50	4 rows	\$8.25

DELUXE SWISS TUNGSTEN VANADIUM BURS

Made of the finest Swiss-milled Vanadium steel for long life and accuracy. All burs are total length of 44.5mm with 3/32" (2.35mm) shanks for quick-change hand-pieces. Our burs are the finest in quality at very reasonable prices and your satisfaction is guaranteed. Each set contains the same shape burs in various sizes. Components of each set listed at right. The hang-up reusable plastic pouch keeps cutting heads apart and takes up very little storage space. Sets with wood stand provide convenience on the bench as well as storage. Individual burs (page 31) packaged six per pack, priced per piece.



Assortments in our hang-up pouch offer space saving storage.



Wood stand assortments offer convenience on the bench.

ROUND ASSORTMENT

MM Sizes:	0.80	0.90	1.00	1.50	1.80	2.10	2.50	2.90	3.50	4.00	4.50	5.00
ISO No.	008	009	010	015	018	021	025	029	035	040	045	050
BUR-500.00	12 pc Round Assortment											\$21.90
BUR-500.05	12 pc Round Assortment in Wood Stand											\$23.05

MM Sizes:	0.80	0.90	1.00	1.20	1.30	1.40	1.50	1.60	1.70	1.80	2.10	2.30
ISO No.	008	009	010	012	013	014	015	016	017	018	021	023
BUR-500.01	12 pc Round Assortment – Small Sizes											\$13.45

CONE ASSORTMENT

MM Sizes:	0.80	0.90	1.00	1.40	1.80	2.10	2.50	2.90	3.50	4.00	4.50	5.00
ISO No.	008	009	010	014	018	021	025	029	035	040	045	050
BUR-510.00	12 pc Cone Assortment											\$29.95

INVERTED CONE ASSORTMENT

MM Sizes:	0.60	0.70	0.80	0.90	1.00	1.20	1.40	1.60	1.80	2.10	2.30	
ISO No.	006	007	008	009	010	012	014	016	018	021	023	
BUR-520.00	11 pc Inverted Cone Assortment											\$11.50

SETTING ASSORTMENT

MM Sizes:	1.00	1.20	1.50	1.70	2.00	2.20	2.50	3.00	3.50	4.00	4.50	5.00
ISO No.	010	012	015	017	020	022	025	030	035	040	045	050
BUR-540.00	12 pc Setting Assortment											\$40.65
BUR-540.05	12 pc Setting Assortment in Wood Stand											\$41.80

CUP ASSORTMENT

MM Sizes:	0.90	1.00	1.20	1.40	1.50	1.60	1.80	2.00	2.30	2.50	2.70	3.00
ISO No.	009	010	012	014	015	016	018	020	023	025	027	030
BUR-560.00	12 pc Cup Assortment											\$27.60
BUR-560.05	12 pc Cup Assortment in Wood Stand											\$28.75

45° HART ASSORTMENT

MM Sizes:	0.90	1.00	1.20	1.40	1.50	1.80	2.10	2.30	2.50	2.70	2.90	3.10
ISO No.	009	010	012	014	015	018	021	023	025	027	029	031
BUR-570.00	12 pc 45° Hart Assortment											\$28.80
BUR-570.05	12 pc 45° Hart Assortment in Wood Stand											\$29.95

MM Sizes:	0.90	1.00	1.20	1.30	1.40	1.50	1.60	1.70	1.80	2.00	2.10	2.30
ISO No.	009	010	012	013	014	015	016	017	018	020	021	023
BUR-570.02	12 pc 45° Hart Assortment – Small Sizes											\$24.20

LARGE 45° HART ASSORTMENT

MM Sizes:	3.30	3.50	3.70	4.00	4.20	4.50	4.70	5.00
ISO No.	033	035	037	040	042	045	047	050
BUR-570.01	8 pc 45° Hart, Large Size Assortment							\$34.50

BUD ASSORTMENT

MM Sizes:	0.80	0.90	1.00	1.40	2.10	2.50	2.90	3.30	3.50	4.00	4.50	5.00
ISO No.	008	009	010	014	021	025	029	033	035	040	045	050
BUR-580.00	12 pc Bud Assortment											\$30.50

WHEEL ASSORTMENT

MM Sizes:	0.60	0.70	0.80	0.90	1.00	1.20	1.40	1.60	1.80	2.10	2.30	
ISO No.	006	007	008	009	010	012	014	016	018	021	023	
BUR-590.00	11 pc Wheel Assortment											\$11.50

CROSS CUT CONE ASSORTMENT

MM Sizes:	0.70	0.80	0.90	1.00	1.20	1.40	1.60	1.80	2.10	2.30	
ISO No.	007	008	009	010	012	014	016	018	021	023	
BUR-610.00	10 pc Cross Cut Cone Assortment										\$12.65



ISO	MM	Round	Cone	Inv. Cone	Setting	Cup	45° Hart	Bud	Wheel	Cross Cut Cone	Krause	Knife Edge
005	0.50	BUR-500.50 \$0.88										
006	0.60	BUR-500.60 \$0.88		BUR-520.60 \$0.88					BUR-590.60 \$0.85			
007	0.70	BUR-500.70 \$0.88		BUR-520.70 \$0.88					BUR-590.70 \$0.85	BUR-610.70 \$0.99		
008	0.80	BUR-500.80 \$0.88	BUR-510.80 \$1.45	BUR-520.80 \$0.88		BUR-560.80 \$1.85		BUR-580.80 \$1.45	BUR-590.80 \$0.85	BUR-610.80 \$0.99		
009	0.90	BUR-500.90 \$0.88	BUR-510.90 \$1.45	BUR-520.90 \$0.88		BUR-560.90 \$1.85	BUR-570.90 \$1.91	BUR-580.90 \$1.45	BUR-590.90 \$0.85	BUR-610.90 \$0.99		
010	1.00	BUR-501.00 \$0.88	BUR-511.00 \$1.45	BUR-521.00 \$0.88	BUR-541.00 \$2.50	BUR-561.00 \$1.85	BUR-571.00 \$1.91	BUR-581.00 \$1.45	BUR-591.00 \$0.85	BUR-611.00 \$0.99	BUR-801.00 \$2.25	BUR-621.00 \$1.92
011	1.10	BUR-501.10 \$0.88				BUR-561.10 \$1.85						
012	1.20	BUR-501.20 \$0.88	BUR-511.20 \$1.45	BUR-521.20 \$0.88	BUR-541.20 \$2.50	BUR-561.20 \$1.85	BUR-571.20 \$1.91	BUR-581.20 \$1.45	BUR-591.20 \$0.85	BUR-611.20 \$0.99	BUR-801.20 \$2.25	BUR-621.20 \$1.92
013	1.30	BUR-501.30 \$0.88				BUR-561.30 \$1.85	BUR-571.30 \$1.91					
014	1.40	BUR-501.40 \$0.88	BUR-511.40 \$1.45	BUR-521.40 \$0.88		BUR-561.40 \$1.85	BUR-571.40 \$1.91	BUR-581.40 \$1.45	BUR-591.40 \$0.85	BUR-611.40 \$0.99		BUR-621.40 \$1.92
015	1.50	BUR-501.50 \$0.88			BUR-541.50 \$2.50	BUR-561.50 \$1.85	BUR-571.50 \$1.91					BUR-621.50 \$1.92
016	1.60	BUR-501.60 \$0.88	BUR-511.60 \$1.45	BUR-521.60 \$0.88	BUR-541.60 \$2.50	BUR-561.60 \$1.85	BUR-571.60 \$1.91	BUR-581.60 \$1.45	BUR-591.60 \$0.85	BUR-611.60 \$0.99		BUR-621.60 \$1.92
017	1.70	BUR-501.70 \$0.88			BUR-541.70 \$2.50	BUR-561.70 \$1.85	BUR-571.70 \$1.91					
018	1.80	BUR-501.80 \$0.88	BUR-511.80 \$1.45	BUR-521.80 \$0.88		BUR-561.80 \$1.85	BUR-571.80 \$1.91	BUR-581.80 \$1.45	BUR-591.80 \$0.85	BUR-611.80 \$0.99		BUR-621.80 \$1.92
019	1.90	BUR-501.90 \$0.88				BUR-561.90 \$1.85	BUR-571.90 \$1.91					
020	2.00	BUR-502.00 \$0.88	BUR-512.00 \$1.45		BUR-542.00 \$2.50	BUR-562.00 \$1.85	BUR-572.00 \$1.91					BUR-622.00 \$1.92
021	2.10	BUR-502.10 \$0.88	BUR-512.10 \$1.45	BUR-522.10 \$0.88		BUR-562.10 \$1.85	BUR-572.10 \$1.91	BUR-582.10 \$1.45	BUR-592.10 \$0.85	BUR-612.10 \$0.99		BUR-622.10 \$1.92
022	2.20	BUR-502.20 \$0.88	BUR-512.20 \$1.45		BUR-542.20 \$2.50		BUR-572.20 \$1.91					
023	2.30	BUR-502.30 \$0.88	BUR-512.30 \$1.45	BUR-522.30 \$0.88		BUR-562.30 \$1.85	BUR-572.30 \$1.91	BUR-582.30 \$1.45	BUR-592.30 \$0.85	BUR-612.30 \$0.99		BUR-622.30 \$1.92
024	2.40	BUR-502.40 \$1.70					BUR-572.40 \$2.88					
025	2.50	BUR-502.50 \$1.70	BUR-512.50 \$2.75		BUR-542.50 \$3.65	BUR-562.50 \$2.88	BUR-572.50 \$2.88	BUR-582.50 \$2.75				
027	2.70	BUR-502.70 \$1.70	BUR-512.70 \$2.75		BUR-542.70 \$3.65	BUR-562.70 \$2.88	BUR-572.70 \$2.88	BUR-582.70 \$2.75				
029	2.90	BUR-502.90 \$1.70	BUR-512.90 \$2.75			BUR-562.90 \$2.88	BUR-572.90 \$2.88	BUR-582.90 \$2.75				
030	3.00				BUR-543.00 \$3.65	BUR-563.00 \$2.88	BUR-573.00 \$2.88					
031	3.10	BUR-503.10 \$1.70	BUR-513.10 \$2.75				BUR-573.10 \$2.88	BUR-583.10 \$2.75				
033	3.30	BUR-503.30 \$2.16			BUR-543.30 \$3.65		BUR-573.30 \$2.88	BUR-583.30 \$2.75				
035	3.50	BUR-503.50 \$2.16	BUR-513.50 \$2.75		BUR-543.50 \$3.65	BUR-563.50 \$2.88	BUR-573.50 \$2.88	BUR-583.50 \$2.75				
037	3.70	BUR-503.70 \$2.16					BUR-573.70 \$4.35					
040	4.00	BUR-504.00 \$2.16	BUR-514.00 \$4.05		BUR-544.00 \$5.35	BUR-564.00 \$4.35	BUR-574.00 \$4.35	BUR-584.00 \$4.05				
042	4.20	BUR-504.20 \$2.16	BUR-514.20 \$4.05				BUR-574.20 \$4.35	BUR-584.20 \$4.05				
045	4.50	BUR-504.50 \$3.65	BUR-514.50 \$4.05		BUR-544.50 \$5.35	BUR-564.50 \$4.35	BUR-574.50 \$4.35	BUR-584.50 \$4.05				
047	4.70						BUR-574.70 \$4.35					
050	5.00	BUR-505.00 \$3.65	BUR-515.00 \$4.05		BUR-545.00 \$5.35	BUR-565.00 \$4.35	BUR-575.00 \$4.35	BUR-585.00 \$4.05				

Burs packaged six per pack, priced per piece.

HIGH-SPEED STEEL BURS

We now offer a complete selection of High-Speed Steel Burs. HSS is known for its hardness and durability. It will stay sharper much longer than conventional tungsten-vanadium. With $\frac{3}{32}$ " shanks, our HSS burs will fit any handpiece. Sold per piece.



HSS BUR SETS

A wide variety of assortments of High-Speed Steel Burs packaged in convenient durable wood storage boxes.

Stock #	Style	Burs Included	Pieces	
BUR-300.50	Round	#1 - #15	15	\$50.39
BUR-300.53	Round	#1 - #30	29	\$110.29
BUR-300.54	Round	#1 - #34	33	\$128.79
BUR-301.50	Cone	#2 - #18	15	\$49.24
BUR-301.52	Cone	#2 - #34	23	\$87.20
BUR-304.52	Setting	#1 - #26	25	\$112.01
BUR-304.54	Setting	#1 - #34	33	\$154.28
BUR-306.51	90° Hart	#1 - #15	15	\$60.37
BUR-306.54	90° Hart	#1 - #34	33	\$154.49
BUR-307.50	45° Hart	#2 - #28 (even)	14	\$67.86
BUR-307.53	45° Hart	#2 - #34	25	\$115.80
BUR-308.50	Bud	#2 - #18	15	\$49.14
BUR-308.52	Bud	#2 - #34	23	\$87.20
BUR-311.50	Flame	#2 - #30 (even)	14	\$68.17
BUR-309.50	Wheel	#5 - #34 (8 round/8 square)	16	\$88.82
BUR-312.50	Cylinder/Inv. Cone	#4 - #34 Cylinder #4 - #30 Inv. Cone	14	\$77.95

CUT LUBE



Hi-tech lubrication for most cutting applications. Use when sawing, drilling or drawing wire to insure cool, clean cuts. Cut Lube adheres to the tool surface and is less affected by heat than oil. Not only does Cut Lube make cutting easier and more precise, but it adds life to all of your cutting tools. The two ounce stick is made in the USA and comes in a convenient push-up plastic sleeve.





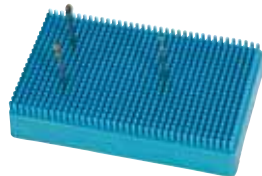







Stock #	Description	
BUR-180.00	2 oz.	\$3.95



We have many different bur holders and accessories - see page 48.



Size	MM	Round	Cone	Inverted Cone	Tree
1	1.05	BUR-300.01 \$2.85			
2	1.20	BUR-300.02 \$2.85	BUR-301.02 \$2.85		
3	1.35	BUR-300.03 \$2.85	BUR-301.03 \$2.85		
4	1.50	BUR-300.04 \$2.85	BUR-301.04 \$2.85		
5	1.70	BUR-300.05 \$2.85	BUR-301.05 \$2.85	BUR-302.05 \$3.45	BUR-303.05 \$3.45
6	1.90	BUR-300.06 \$2.85	BUR-301.06 \$2.85		
7	2.10	BUR-300.07 \$2.85	BUR-301.07 \$2.85		
8	2.30	BUR-300.08 \$2.85	BUR-301.08 \$2.85	BUR-302.08 \$3.45	BUR-303.08 \$3.45
9	2.50	BUR-300.09 \$3.40	BUR-301.09 \$3.40		
10	2.70	BUR-300.10 \$3.40	BUR-301.10 \$3.40		
11	2.90	BUR-300.11 \$3.40	BUR-301.11 \$3.40		
12	3.10	BUR-300.12 \$3.40	BUR-301.12 \$3.40		
13	3.30	BUR-300.13 \$4.05	BUR-301.13 \$4.05	BUR-302.13 \$5.15	BUR-303.13 \$5.10
14	3.50	BUR-300.14 \$4.05	BUR-301.14 \$4.05		
15	3.80	BUR-300.15 \$4.05			
16	4.00	BUR-300.16 \$4.05	BUR-301.16 \$4.05		
17	4.30	BUR-300.17 \$4.05			
18	4.50	BUR-300.18 \$4.05	BUR-301.18 \$4.05		
19	4.70	BUR-300.19 \$4.75		BUR-302.19 \$5.75	BUR-303.19 \$5.75
20	5.00	BUR-300.20 \$4.75	BUR-301.20 \$4.75		
22	5.20	BUR-300.22 \$4.75	BUR-301.22 \$4.75		
23	5.40	BUR-300.23 \$4.75			
24	5.60	BUR-300.24 \$4.75	BUR-301.24 \$4.75		
25	5.90	BUR-300.25 \$4.75			
26	6.30	BUR-300.26 \$6.05	BUR-301.26 \$6.05	BUR-302.26 \$6.15	BUR-303.26 \$6.15
27	6.70	BUR-300.27 \$6.05			
28	7.20	BUR-300.28 \$6.05	BUR-301.28 \$6.05		
29	7.60	BUR-300.29 \$6.20			
30	8.00	BUR-300.30 \$6.20	BUR-301.30 \$6.05	BUR-302.30 \$6.40	BUR-303.30 \$6.40
31	8.90	BUR-300.31 \$6.75			
32	9.60	BUR-300.32 \$6.75	BUR-301.32 \$6.75		
33	10.40	BUR-300.33 \$7.25			
34	11.00	BUR-300.34 \$7.25	BUR-301.34 \$7.25		

											
Size	MM	Setting	90° Hart	45° Hart	Bud	Square Edge Wheel	Round Edge Wheel	Flame	Cylinder	Slim Reamer	Cone Reamer
1	1.05	BUR-304.01 \$3.40	BUR-306.01 \$3.45								
2	1.20	BUR-304.02 \$3.40	BUR-306.02 \$3.45	BUR-307.02 \$3.45	BUR-308.02 \$2.85			BUR-311.02 \$3.45			
3	1.35	BUR-304.03 \$3.40	BUR-306.03 \$3.45	BUR-307.03 \$3.45	BUR-308.03 \$2.85						
4	1.50	BUR-304.04 \$3.40	BUR-306.04 \$3.45	BUR-307.04 \$3.45	BUR-308.04 \$2.85			BUR-311.04 \$3.45			
5	1.70	BUR-304.05 \$3.40	BUR-306.05 \$3.45	BUR-307.05 \$3.45	BUR-308.05 \$2.85	BUR-309.05 \$3.45	BUR-310.05 \$3.45		BUR-312.05 \$3.45		
6	1.90	BUR-304.06 \$3.40	BUR-306.06 \$3.45	BUR-307.06 \$3.45	BUR-308.06 \$2.85			BUR-311.06 \$3.45			
7	2.10	BUR-304.07 \$3.40	BUR-306.07 \$3.45	BUR-307.07 \$3.45	BUR-308.07 \$2.85						
8	2.30	BUR-304.08 \$3.40	BUR-306.08 \$3.45	BUR-307.08 \$3.45	BUR-308.08 \$2.85	BUR-309.08 \$3.45	BUR-310.08 \$3.45	BUR-311.08 \$3.45	BUR-312.08 \$3.45		
9	2.50	BUR-304.09 \$4.05	BUR-306.09 \$4.05	BUR-307.09 \$4.05	BUR-308.09 \$3.45					BUR-313.09 \$4.35	
10	2.70	BUR-304.10 \$4.05	BUR-306.10 \$4.05	BUR-307.10 \$4.05	BUR-308.10 \$3.45			BUR-311.10 \$4.40			
11	2.90	BUR-304.11 \$4.05	BUR-306.11 \$4.05	BUR-307.11 \$4.05	BUR-308.11 \$3.45						
12	3.10	BUR-304.12 \$4.05	BUR-306.12 \$4.05	BUR-307.12 \$4.05	BUR-308.12 \$3.45			BUR-311.12 \$4.40			
13	3.30	BUR-304.13 \$4.85	BUR-306.13 \$4.85	BUR-307.13 \$4.85	BUR-308.13 \$4.05	BUR-309.13 \$4.85	BUR-310.13 \$4.85		BUR-312.13 \$5.05	BUR-313.13 \$5.10	
14	3.50	BUR-304.14 \$4.85	BUR-306.14 \$4.85	BUR-307.14 \$4.85	BUR-308.14 \$4.05			BUR-311.14 \$4.40			
15	3.80	BUR-304.15 \$4.85	BUR-306.15 \$4.85	BUR-307.15 \$4.85							
16	4.00	BUR-304.16 \$4.85	BUR-306.16 \$4.85	BUR-307.16 \$4.85	BUR-308.16 \$4.05	BUR-309.16 \$4.85	BUR-310.16 \$4.85	BUR-311.16 \$5.05	BUR-312.16 \$5.05		
17	4.30	BUR-304.17 \$4.85	BUR-306.17 \$4.85	BUR-307.17 \$4.85							
18	4.50	BUR-304.18 \$4.85	BUR-306.18 \$4.85	BUR-307.18 \$4.85	BUR-308.18 \$4.05			BUR-311.18 \$5.05			
19	4.70	BUR-304.19 \$5.35	BUR-306.19 \$5.35	BUR-307.19 \$5.35		BUR-309.19 \$5.35	BUR-310.19 \$5.35		BUR-312.19 \$5.65	BUR-313.19 \$5.65	
20	5.00	BUR-304.20 \$5.35	BUR-306.20 \$5.35	BUR-307.20 \$5.35	BUR-308.20 \$4.75			BUR-311.20 \$5.65			
22	5.20	BUR-304.22 \$5.35	BUR-306.22 \$5.35	BUR-307.22 \$5.35	BUR-308.22 \$4.75			BUR-311.22 \$5.65			
23	5.40	BUR-304.23 \$5.35	BUR-306.23 \$5.35								
24	5.60	BUR-304.24 \$5.35	BUR-306.24 \$5.35	BUR-307.24 \$5.35	BUR-308.24 \$4.75			BUR-311.24 \$5.65			
25	5.90	BUR-304.25 \$5.35	BUR-306.25 \$5.35								
26	6.30	BUR-304.26 \$6.05	BUR-306.26 \$6.05	BUR-307.26 \$6.05	BUR-308.26 \$6.05	BUR-309.26 \$6.05	BUR-310.26 \$6.05	BUR-311.26 \$6.25	BUR-312.26 \$6.25		BUR-314.26 \$6.25
27	6.70	BUR-304.27 \$6.05	BUR-306.27 \$6.05								
28	7.20	BUR-304.28 \$6.25	BUR-306.28 \$6.25	BUR-307.28 \$6.205	BUR-308.28 \$6.05						
29	7.60	BUR-304.29 \$6.25	BUR-306.29 \$6.25								
30	8.00	BUR-304.30 \$6.25	BUR-306.30 \$6.25	BUR-307.30 \$6.25	BUR-308.30 \$6.15	BUR-309.30 \$6.40	BUR-310.30 \$6.40	BUR-311.30 \$6.50	BUR-312.30 \$6.65		BUR-314.30 \$6.65
31	8.90	BUR-304.31 \$7.15	BUR-306.31 \$7.15								
32	9.60	BUR-304.32 \$7.15	BUR-306.32 \$7.15		BUR-308.32 \$6.75						
33	10.40	BUR-304.33 \$7.75	BUR-306.33 \$7.75								
34	11.00	BUR-304.34 \$7.75	BUR-306.34 \$7.75	BUR-307.34 \$7.75	BUR-308.34 \$7.25	BUR-309.34 \$7.55	BUR-310.34 \$7.55		BUR-312.34 \$8.00		

Inside Ring Burs are great for smoothing and finishing the insides of rings.

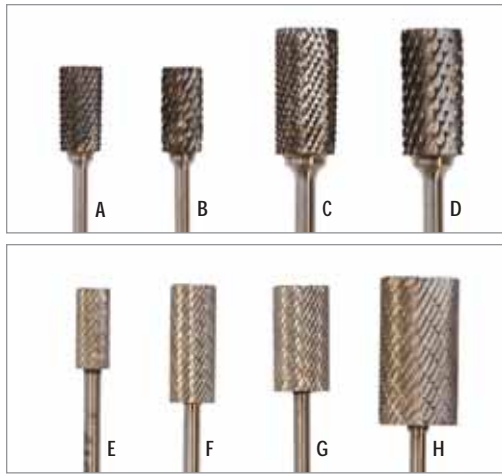

INSIDE RING BURS

Made of carbide steel to assure extra long life, these tools are used for deburring, smoothing and finishing the insides of rings.

Stock #	Head Dia.	Head Length	Shank	Cut	
A. BUR-970.00	1/4"	1/2"	3/32"	Fine	\$12.75
B. BUR-972.00	1/4"	1/2"	3/32"	Coarse	\$12.75
C. BUR-974.00	3/8"	3/4"	1/8"	Fine	\$21.65
D. BUR-976.00	3/8"	3/4"	1/8"	Coarse	\$21.65

Also available an extra fine cut inside ring bur in high speed steel. All with 3/32" shanks, four diameter choices.

Stock #	Head Dia. (mm)	Shank	Cut	
E. BUR-978.19	4.70	3/32"	Extra Fine	\$5.30
F. BUR-978.26	6.30	3/32"	Extra Fine	\$6.10
G. BUR-978.30	8.00	3/32"	Extra Fine	\$6.50
H. BUR-978.34	11.10	3/32"	Extra Fine	\$8.50

KRAUSE BURS

German-made precision tungsten vanadium Krause burs to finish hard-to-reach places. Per pack of six; priced per each.

Stock #	Description	
I. BUR-000.10	1.0mm	\$1.85
J. BUR-000.12	1.2mm	\$1.85

MASTER SWISS BUR SET

This 24 piece bur set offers Swiss-made round, cup, bud, hart and setting burs of smaller sizes all in one set. Shanks are 3/32" (2.35mm) and are made of super hard Tungsten Vanadium. Packaged in a handy organizer with lid. See page 31 for individual replacement burs.

Stock #	
K. BUR-400.00	\$49.95

24 PC SWISS BUR SET ASSORTMENT

These burs are made of the finest Swedish Tool Steel in precision Swiss factories that specialize in the very finest cutting instruments in the world. Each set comes in a plastic stand with a clear dome lid and 3/32" shanks. Sizes 1.00 to 7.20mm. Shapes include: Round, Bur, Hart, Setting, Cone, Finishing, Flame, Cup, Oval, Cylinder and many more (shapes will vary).

Stock #	
L. BUR-416.00	\$36.95

KLEIN BURS

Made in England, Klein burs are equal to any of the better known brands of Tungsten Vanadium Burs. Available in the most popular sizes and shapes, Klein burs are manufactured on the most modern equipment with methods which give Klein burs the edge in economy without sacrificing quality. All are total length of 44.5mm with 3/32" (2.35mm) shanks for quick-change handpieces. Try Klein burs, we guarantee your satisfaction. Per pack of six, priced per each.

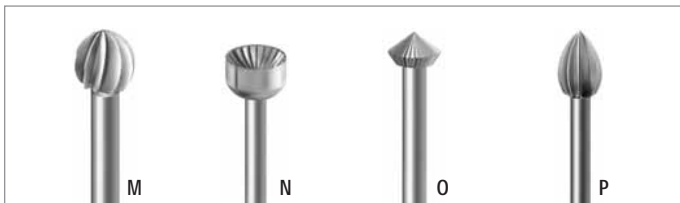

M. ROUND BURS (priced per each)

BUR-700.50	0.50mm	\$0.61
BUR-700.60	0.60mm	\$0.61
BUR-700.70	0.70mm	\$0.61
BUR-700.80	0.80mm	\$0.61
BUR-700.90	0.90mm	\$0.61
BUR-701.00	1.00mm	\$0.61
BUR-701.20	1.20mm	\$0.61
BUR-701.30	1.30mm	\$0.61
BUR-701.40	1.40mm	\$0.61
BUR-701.50	1.50mm	\$0.61
BUR-701.60	1.60mm	\$0.61
BUR-701.70	1.70mm	\$0.61
BUR-701.80	1.80mm	\$0.61
BUR-702.00	2.00mm	\$0.61
BUR-702.10	2.10mm	\$0.61
BUR-702.30	2.30mm	\$0.61

N. CUP BURS (priced per each)

BUR-760.80	0.80mm	\$1.55
BUR-760.90	0.90mm	\$1.55
BUR-761.00	1.00mm	\$1.55
BUR-761.20	1.20mm	\$1.55
BUR-761.30	1.30mm	\$1.55
BUR-761.40	1.40mm	\$1.55
BUR-761.50	1.50mm	\$1.55
BUR-761.60	1.60mm	\$1.55
BUR-761.70	1.70mm	\$1.55
BUR-761.80	1.80mm	\$1.55
BUR-762.00	2.00mm	\$1.55
BUR-762.10	2.10mm	\$1.55
BUR-762.30	2.30mm	\$1.55

O. 45° HART BURS (priced per each)

BUR-770.90	0.90mm	\$1.50
BUR-771.00	1.00mm	\$1.50
BUR-771.20	1.20mm	\$1.50
BUR-771.30	1.30mm	\$1.50
BUR-771.40	1.40mm	\$1.50
BUR-771.50	1.50mm	\$1.50
BUR-771.60	1.60mm	\$1.50
BUR-771.70	1.70mm	\$1.50
BUR-771.80	1.80mm	\$1.50
BUR-771.90	1.90mm	\$1.50
BUR-772.00	2.00mm	\$1.50
BUR-772.10	2.10mm	\$1.50
BUR-772.30	2.30mm	\$1.50

P. BUD BURS (priced per each)

BUR-780.90	0.90mm	\$0.68
BUR-781.00	1.00mm	\$0.68
BUR-781.20	1.20mm	\$0.68
BUR-781.40	1.40mm	\$0.68
BUR-781.50	1.50mm	\$0.68
BUR-781.60	1.60mm	\$0.68
BUR-781.80	1.80mm	\$0.68
BUR-782.00	2.00mm	\$0.68
BUR-782.10	2.10mm	\$0.68
BUR-782.30	2.30mm	\$0.68

FCC CHAMPION CUP™ BUR

A revolutionary, patented cup bur design. The “Champion Cup” has no inner blades, instead it features two ‘slotted’ openings opposing each other. Outstanding, “smooth” surface prong eliminates additional polishing procedure. No “clogging” on softer metals and particularly good for platinum. Guaranteed to outlast conventional cup burs over two times. The FCC Champion Cup is the ultimate cup bur for reaching tight places and rounding prongs that are very close together, because it has an extra thin wall – a setter’s favorite. Packaged per six; priced per piece.



See our complete section of diamond coated instruments – page 66.

Stock #	Description	
A. BUR-040.80	0.80mm	\$2.15
BUR-041.00	1.00mm	\$2.15
BUR-041.20	1.20mm	\$2.15
BUR-041.40	1.40mm	\$2.15
BUR-041.60	1.60mm	\$2.15
BUR-041.80	1.80mm	\$2.15

DELUXE CARVING KIT

Kit contains 12 assorted burs with aggressive flutes and strong 1/8" shanks for serious carving in wax, wood, and even metals. Burs are Swiss made and supplied in a plastic bur stand with clear dome cover.

Stock #	Description	Shank	
B. BUR-925.00	12 pc Carving Set	1/8"	\$18.85



B

Our coarse fluted burs are excellent for carving wood as well as wax.

24 PIECE WAX BUR SET

This 24 piece set offers the largest variety of wax burs available in a single set. All are Swiss made Tungsten Vanadium with deep flutes for carving wax when designing jewelry and other items. Our wax bur set is also excellent for woodworking and plastic. All burs have 3/32" shanks and approximately 44.5mm total length.

Stock #	Description	Shank	
C. BUR-905.24	24 pc Assorted Wax Bur Set	3/32"	\$59.25



C

WAX BUR SETS

Three different wax bur sets in attractive point-of-purchase packages or wood stands. Each Swiss bur features coarse, no-clog flutes and are made of Tungsten Vanadium for years of service. Shanks are a EURO TOOL exclusive 3/32" for quick change handpieces. Excellent for WOOD or PLASTIC. Available in sets only. Sets may vary slightly.

D. Sets in Hang-Up Packaging

Stock #	Description	Shank	
BUR-930.00	Set of 12, Small Sizes	3/32"	\$14.95
BUR-935.00	Set of 12, Medium Sizes	3/32"	\$25.10
BUR-940.00	Set of 5, Large Sizes	3/32"	\$17.50



D

E. Sets in Wood Stand

Stock #	Description	Shank	
BUR-930.05	Set of 12, Small Sizes	3/32"	\$16.00
BUR-935.05	Set of 12, Medium Sizes	3/32"	\$26.15

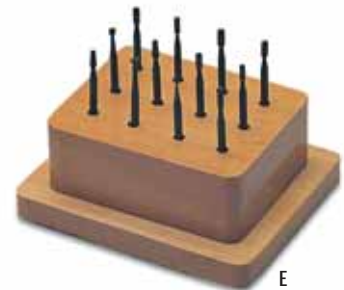

E

DETAILERS WAX BUR KIT

Kit contains a round wax bur, helix wax bur and four detail carving burs. Swiss-made, 3/32" shanks.

Stock #	Description	Shank	
F. BUR-906.00	6 pc Wax Bur Set	3/32"	\$8.40

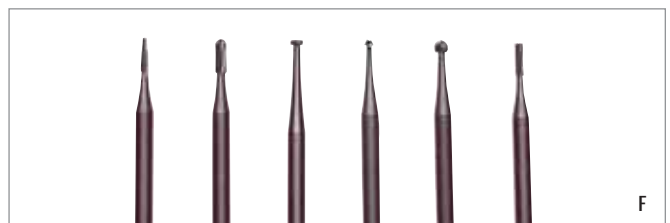

F

WAX BUR SET OF 10

Made of tool steel and great for wax carving or wood carving. The burs are deep-fluted so they do not clog. Each of the ten pieces is a different shape and features 1/8" (3mm) shanks. Packaged in convenient hang-up pouch. Available as a set only.

Stock #	Description	Shank	
G. BUR-950.00	Set of 10	1/8"	\$31.20

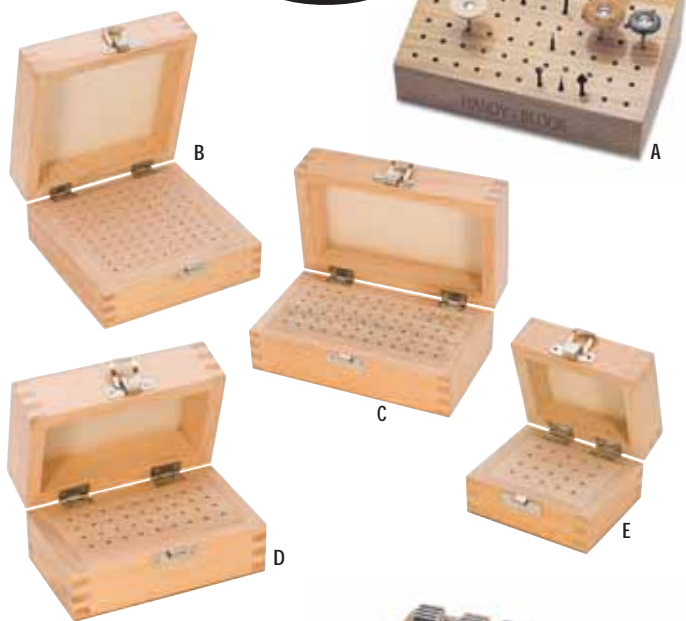

G

EURO TOOL®
original**HANDY BLOCK**

Our HANDY BLOCK is a 4 1/2" x 6" block of cured hardwood with 88 holes for organizing burs, needle files, beaders, mini brushes, etc. Each hole is 1/8" in diameter to accommodate either 1/8" or 3/32" shanks. This block is slanted so the user can see all instruments at a glance. The HANDY BLOCK also features stay-put rubber pads on the bottom to keep it from sliding. A EURO TOOL original!

Stock #

A. HOL-348.00

\$14.95

WOOD STORAGE BOXES

Nicely finished wood boxes allow you to store your burs or create your own assortments. Great for any 3/32" or 1/8" shank instruments including burs, drills, mini brushes, buffs, etc.

Stock #	Size	No. of Holes	
B. PKG-100.00	5 1/2" x 5 1/2"	100 Holes	\$15.95
C. PKG-172.00	6 1/4" x 3 1/2"	72 Holes	\$15.55
D. PKG-136.00	4 7/8" x 3"	36 Holes	\$8.25
E. PKG-120.00	3" x 5"	20 Holes	\$7.40

HANDY BUR BOX

Wood compartment bur box is simply for storing burs. Most jewelers and setters prefer to leave burs in the plastic boxes for easy identification. This box holds small and large packages and has removable dividers which keep boxes upright to easily identify the size and shape. Made of wood and attractively finished, it should be a must for every bench.

Stock #

F. HOL-350.00

\$10.95

ROTATING BUR ORGANIZER

Stop wasting time searching for lost tools! This rotating bur organizer which rotates on steel ball bearings is the best answer to keeping burs, mini brushes, drills, diamond points or anything else which fits into a handpiece from being lost. Holds up to 156 items with 108 holes sized for 3/32" shank instruments and 48 larger holes for 1/8" shank tools. Height 3 3/4" (9.5cm).

Stock #

G. HOL-355.00

\$15.95

LUCITE BUR and ACCESSORIES BLOCK

Attractive and functional, this 40-hole bur block measuring 4 1/4" x 3" x 3/4" puts burs, drills, mini brushes and other 3/32" shank tools at your fingertips. Made of high-impact lucite, you'll get years of service from this handy organizer.

Stock #

H. HOL-340.00

\$5.95

BUR HOLDER

Bristle block holds burs, mini buffs, brushes and any 3/32" shank attachments. Injection-molded plastic measuring 3" x 5" x 7/8". Perfect organizer for any bench.

Stock #

I. BUR-350.00

\$5.45

ATTACHABLE BUR BLOCKS

Simple 40 hole plastic blocks can be attached together to store unlimited number of mini brushes, buffs, drills, beading tools, needle files and much more. Measures 4 1/4" x 3 1/8" with 3/32" holes.

Stock #

J. HOL-332.10

\$2.95

ROUND WOOD TOOL STAND

This new hardwood stand, designed by EURO TOOL makes keeping your deluxe wax carvers handy. With a one inch center cavity to store extra carvers or other tools, and holes in the base to store burs or mini brushes, you'll get a lot of good out of this practical stand. Unique in appearance and design, this unit is 2 1/2" tall with a base diameter of 4 1/8" and weighs 6.3 ounces.

Stock #

K. HOL-360.00

\$13.95

Rotates to keep all your accessories at your fingertips.



Great for holding carvers!

New!

**MAGNETIC BUR HOLDER**

This magnetic bur holder keeps burs readily available for the busy jeweler. Made of high impact plastic, with an extra strong magnet for quick retrieval of burs, drills and other rotary instruments.

Stock #

HOL-335.00

\$11.95



New!

WAX DETAILER SET

A phenomenal tool for filing and shaping wax and enlarging small holes where necessary. Our detailers are extremely small to work in tight places where other tools cannot reach. Quickly and smoothly cut with very sharp spiral, file-like edges. Detail filigree with ease and clean small, tight corners in wax patterns. Stainless steel tips will not rust. Spiral cut sheds the wax so it will not load up. This set features fine and very fine detailers with comfortable wood handles. American made.

Stock #	Description	Tip Diameter	
A. CVR-505.15	Set of 2		\$10.25
CVR-505.05	Very Fine	0.6mm	\$5.15
CVR-505.10	Fine	1.0mm	\$5.15



SWIVEL BLADE WAX CARVERS

Our swivel blade wax carvers are handy tools for rounding edges, especially the inside of wax rings. The easy grip aluminum handle is made of anodized aluminum. The cutting blade smoothly swivels, making it easy to follow curved edges.

Stock #	Description	Length	Handle Diameter	
B. CVR-510.00	Carver	5"	5/8"	\$12.95
C. CVR-512.00	Carver - Pencil Type	5"	5/16"	\$10.90



WAX CUTTING MANDREL

Use this steel ring mandrel for a quick and convenient way to size wax ring models. Six sharp blades running from the tip to the handle act as a reaming tool on wax models and ring tubes.

Stock #	Length	Weight	
D. MAN-340.00	8 3/4"	1 lb.	\$38.95



WAX CARVERS – SHARP EDGE, EASY CUTTING

This new set, made of high grade, non-rust, non-corrosive, stainless steel features all new shapes that cut or scrape wax the way you need to. Ergonomic shapes give the user the ability to get into tight places, at the correct angles for nooks and corners. Handles are non-roll octagonal and cross-grooved for a firm but pleasant grip. Heads feature sharp edges to cut properly, eliminating additional smoothing.

Stock #	Description	Length	Blade Width	
CVR-550.12	Set of 6 (A – F)			\$19.95
E. CVR-550.01	90° Flat Small	6"	3.40mm (1/8")	\$3.45
F. CVR-550.02	90° Flat Large	6"	6.80mm (1/4")	\$3.45
G. CVR-550.03	30° Angled	6"	3.40mm (1/8")	\$3.45
H. CVR-550.05	Sharp Claw	6"	Pointed	\$3.45
I. CVR-550.06	Small Chisel	6"	1.60mm (1/16")	\$3.45
J. CVR-550.07	Scooper	6"	4mm (3/16")	\$3.45



WAX CARVING FILES

This idea makes a lot of sense – files made specifically for wax carving. Single cut teeth won't clog and the files can be held like a pen for good control. Overall length of 6 3/4" with a cut length of 1".

Stock #	Description	
FIL-755.00	Set of 4	\$19.95
K. FIL-750.00	Flat	\$4.95
L. FIL-750.05	Three-Square	\$4.95
M. FIL-750.03	Flat, 1 Side Cut	\$4.95
N. FIL-750.10	Half-Round	\$4.95



EUROPOINT PRECISION WAX CARVING FILES

With pointed tips for fine work, each Europoint Precision Carver features single cuts, which will not clog, yet leaves a smooth surface. Made of stainless steel with sure-grip handles, they are the only files of this type available today. 5 1/2" length.

Stock #	Description	Point Size	
FIL-740.00	3 Pc Europoint Wax File Set		\$14.95
O. FIL-740.01	Small Point	2.20mm x 10.50mm	\$4.75
P. FIL-740.03	Medium Point	3.20mm x 11.50mm	\$4.75
Q. FIL-740.05	Large Point	4.10mm x 19.50mm	\$4.75



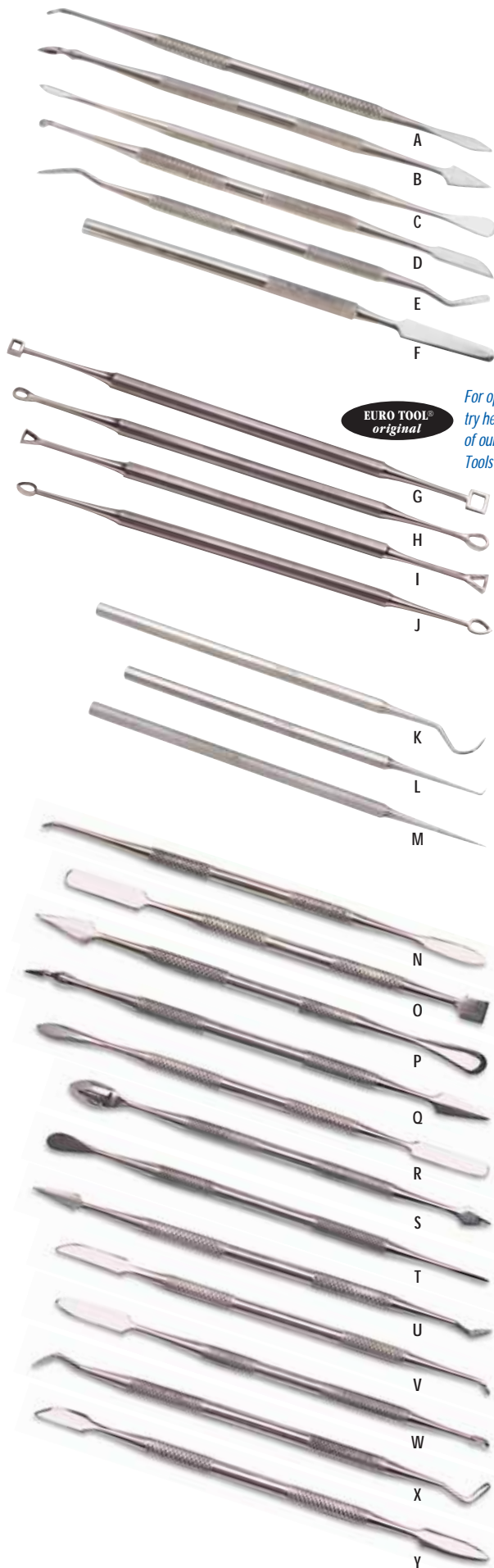

EURO TOOL®
original

*For optimal use,
try heating the tips
of our Wax Carving
Tools Supreme!*



WAX CARVING TOOLS SUPREME

A revolutionary change in wax carvers which allows the user to actually carve the wax rather than scrape it away. Available in four shapes, with two sizes on each tool, the loops are sharp on one edge. Great to make designs, to smooth or to use with wax lathes for making rings. Each carver is made of surgical-grade stainless steel with a sure-grip handle. Developed and manufactured exclusively for EURO TOOL.

Stock #	Description	Length	
CVR-500.00	Set of 4		\$24.95
G. CVR-500.10	Square	7"	\$7.95
H. CVR-500.15	Round	7"	\$7.95
I. CVR-500.20	Triangle	7"	\$7.95
J. CVR-500.25	Spade	7"	\$7.95

PICKS

Originally used as dental explorers, picks are excellent for a variety of uses including scribing, positioning, probing, etc. All are fine stainless steel with knurled handles. Sold as a set or individually.

Stock #	Description	Length	
CVR-530.00	Set of 3		\$8.15
K. CVR-400.10	Hook	5 1/2"	\$2.65
L. CVR-400.20	Bent	5 1/2"	\$2.65
M. CVR-400.30	Straight	6"	\$2.65

DOUBLE ENDED SPATULAS/CARVERS

Stainless steel carvers with knurled handles are offered in a wide variety of shapes and styles for every use. Overall length approximately 6 1/2" with 12 different shapes to choose from. Convenient 12 piece set is packaged in a foldover pouch.

Stock #	Description	
CVR-312.00	Set of 12 (I-T)	\$29.95

Individual Carvers

Stock #	Description	Length	
N. CVR-312.05	Double Ended	6 1/2"	\$2.65
O. CVR-312.10	Double Ended	6 1/2"	\$2.65
P. CVR-312.15	Double Ended	6 1/2"	\$2.65
Q. CVR-312.20	Double Ended	6 1/2"	\$2.65
R. CVR-312.25	Double Ended	6 1/2"	\$2.65
S. CVR-312.30	Double Ended	6 1/2"	\$2.65
T. CVR-312.35	Double Ended	6 1/2"	\$2.65
U. CVR-312.40	Double Ended	6 1/2"	\$2.65
V. CVR-312.45	Double Ended	6 1/2"	\$2.65
W. CVR-312.50	Double Ended	6 1/2"	\$2.65
X. CVR-312.55	Double Ended	6 1/2"	\$2.65
Y. CVR-312.60	Double Ended	6 1/2"	\$2.65



*Our HOL-356.00 Tool Stand
offers convenient and safe
storage for carvers.*

DOUBLE-ENDED "SCOOP" CARVERS

Two double-ended "scoop" type carvers offer four sizes. Popular for years in the pottery industry, we've found these sharp-edge tools excellent for carving, transferring wax, etc. Made of rust-free stainless steel.

Stock #	Description	Length	
A. CVR-430.10	Small - 3.20mm and 4.25mm	5 ¹ / ₄ "	\$4.15
B. CVR-430.20	Large - 5.25mm and 7.35mm	5 ¹ / ₄ "	\$4.15
CVR-430.25	Set of 2 - Small and Large Scoop Carvers		\$8.10



TEN PIECE CARVER SET

Why not have a carver set of ten that you can really handle? This set offers the best in cutting and shaping technology. Excellent for metal clay work. The PVC handles are a comfortable 5/16" (8.35mm) in diameter and all have sharp edges for shaping and fine detailing. Overall length is 5³/₄" (145mm). The metal used is high quality stainless steel for years of life. Enjoy carving and shaping with this well balanced set, and the results will be very rewarding. Safely stored in protective wood box.

Stock #	Description	
C. CVR-220.00	Set of Ten in Wood Storage Box	\$34.95



MAX WAX PENS

Our wax pens are the ultimate cordless wax tools. Instant heat up to 850 °F with finger pressure control, makes it ideal for design work, spruing, or for everyday bench jobs. Form beads and details, whisk away flares or spray and repair floaters and accidents. The tip is specially designed to transfer wax to models. Max Wax Powered by one AA battery, Super Max Wax powered by two AA batteries (included).

Stock #	Description	Length	
D. PEN-500.00	Max Wax Pen	6 ³ / ₄ "	\$24.95
E. PEN-520.00	Super Max Wax Pen	8 ¹ / ₂ "	\$26.95
PEN-500.01	Replacement Tip for Max Wax		\$5.95
F. PEN-500.30	3 Piece Special Tip Set		\$15.75



SOLDERING IRON

This portable soldering iron is excellent for touch-up, spruing waxes, etc. Heats up to 700 °F and keeps recharging every time it is placed back into the recharging stand, so it is always ready to use. Lasts approximately 40 minutes on a full charge. Tip length 1". Includes soldering iron, fine tip and recharging stand.

Stock #	Description	
G. CVR-610.00	Soldering Iron	\$53.95
CVR-610.05	Fine Tip	\$7.50
CVR-610.10	Heavy Tip	\$7.50



DELUXE WAX CARVING SET

This all inclusive 13 piece kit comes in a smart wooden box to keep tools at hand. This set is comprised of our best and most popular wax tools. Virtually everything one needs to design and finish wax models or patterns. Box measures 9¹/₄" L x 6¹/₄" W x 1¹/₄" H. Set includes:

- Six sharp-edge wax carvers - our supreme set, the finest made.
- Max Wax pen (battery included)
- Two wax detailers for precision work - will not clog.
- Three Precision Wax Files - leaves surfaces smooth, non-clogging.
- One 10X loupe.

Stock #		
H. CVR-105.00		\$59.95





Handpiece and tips also available separately.

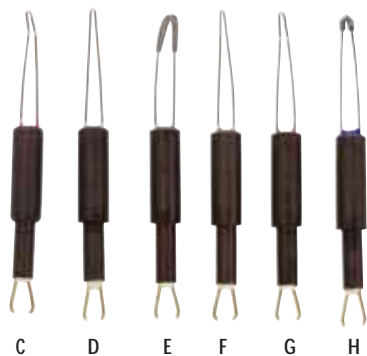

ELECTRIC WAX WORKER

Heavy duty steel body with comfortable non-warming handpiece. Handpiece is designed with eight individual non-flammable wires to provide optimal flexibility and heat resistance. Handpiece is made of lightweight fiber to stay cool and accommodates most tips of other wax workers. A sturdy handpiece holder is located on the top right of the machine. The control box on this unit delivers precise heat and can be precisely varied for different waxes and effects. Standard in 120 volts, and available in 220 volts upon request. Unit is UL listed and approved to meet and exceed all safety standards. The unit is standard with a three-prong grounded plug for maximum safety. The on/off rocker switch is illuminated when the unit is on. Furnished with one tip (WAX-207.01). Full one year warranty on all parts and labor.

Stock #	Description	
A. WAX-205.00	Electric Wax Worker	\$130.00

ELECTRIC WAX WORKER HANDPIECE

A replacement handpiece for wax workers. Designed with eight individual non-flammable and non-warming wires to provide optimal flexibility and heat resistance. The handpiece itself is designed with high quality lightweight fiber to stay cool during any length of operation. The handpiece accommodates most tips of other wax workers as well.

Stock #	Description	
B. WAX-206.00	Handpiece only	\$31.85

WAX WORKER TIPS

Replacement tips for Electric Wax Worker (above) as well as most wax workers. Long lasting and very durable. Made with fine fiber. Variety of tip styles for various patterns and designs.

Stock #	Description	
C. WAX-207.01	Red Tip	\$7.95
D. WAX-207.02	Yellow Tip	\$7.95
E. WAX-207.03	Pink Tip	\$7.95
F. WAX-207.04	Green Tip	\$7.95
G. WAX-207.05	Orange Tip	\$7.95
H. WAX-207.06	Blue Tip	\$7.95

STARWAX 15 DIGITAL INJECTOR

Medium duty injector has a 1.5 quart (1.5 liters) capacity with 300 watts of power. Like our large capacity model this injector comes complete with a hand pump for a self-contained air pressure unit. The wax container is made of aluminum so it will obtain an even diffusion of heat. The size of this unit is 8 $\frac{1}{4}$ " x 9 $\frac{1}{2}$ " x 19 $\frac{1}{2}$ " (205 x 235 x 490mm). Made in Italy. Weight is 19.8 lbs. (9kg).

Stock #		
I. CAS-415.00		\$624.75

STARWAX 30 DIGITAL INJECTOR

Our large capacity MasterWax Digital Injector holds up to 3 quarts (3 liters) of wax. The wax container is made of aluminum so it will obtain an even diffusion of heat. Comes complete with a hand pump for a self-contained air pressure unit. Temperature is controlled with a digital thermostat. Rugged and sturdy enough for production use. Power is 350 watts with a size of 9 $\frac{1}{2}$ " x 10 $\frac{1}{2}$ " x 21" (240 x 265 x 525mm). Made in Italy. Weight 22 lbs. (10kg).

Stock #		
J. CAS-430.00		\$708.75

See our complete line of Injection Waxes on page 54.

Some time ago Kate Wolf asked herself, "Why aren't carving waxes colored to better resemble gold, silver or platinum?" She decided to ask the jewelry wax specialists at Ferris® for help. And help they did...Jointly developed by Kate and the Ferris® wax research laboratory is a true "first" in the international jewelry wax industry...waxes that once carved, possess a gold or silver-toned appearance. Finally, your customers will be able to envision all the wonderful creativity of your wax carving. "Stones look great in these new waxes. They're bright...they shine..."

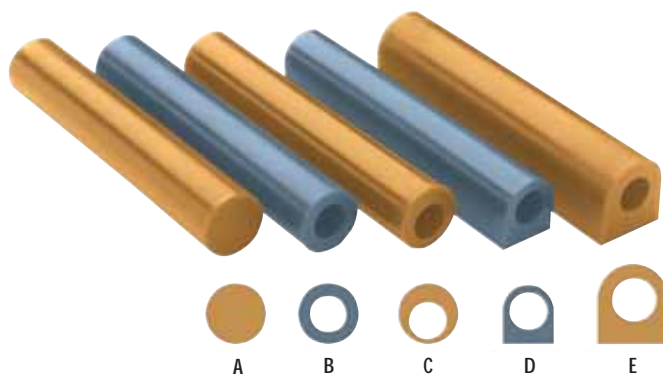

WOLF CARVING WAXES BY FERRIS™

This line of flexible, medium hard waxes can be carved into the finest design detail and polished to an incredibly smooth finish. Once carved, they possess a gold or silver-toned appearance. Wolf Waxes™ are machinable, carvable and strong – plus they're extremely easy to read and total delight to carve.

WOLF WAX™ RING TUBES, BLOCKS AND SLICES

Stock #	Description	Size	
A. WAX-261.01	Solid Ring Tube - Gold	1 ¹ / ₁₆ " O.D.	\$7.95
WAX-261.03	Solid Ring Tube - Silver	1 ¹ / ₁₆ " O.D.	\$7.95
WAX-262.01	Round Tube with Centered Hole - Gold	1 ¹ / ₁₆ " O.D.	\$7.95
WAX-262.03	Round Tube with Centered Hole - Silver	1 ¹ / ₁₆ " O.D.	\$7.95
C. WAX-263.01	Round Tube with Off-Centered Hole - Gold	1 ¹ / ₁₆ " O.D.	\$7.95
WAX-263.03	Round Tube with Off-Centered Hole - Silver	1 ¹ / ₁₆ " O.D.	\$7.95
WAX-264.01	Flat Top - Gold	1 ¹ / ₈ " O.D.	\$7.95
D. WAX-264.03	Flat Top - Silver	1 ¹ / ₈ " O.D.	\$7.95
E. WAX-265.01	Large Flat Top - Gold	6" L x 1 ³ / ₁₆ " W x 1 ⁵ / ₁₆ " H	\$8.95
WAX-265.03	Large Flat Top - Silver	6" L x 1 ³ / ₁₆ " W x 1 ⁵ / ₁₆ " H	\$8.95
F. WAX-253.01	Gold Block - 1 lb.	3 ³ / ₁₆ " Square x 2 ³ / ₈ " Thick	\$14.45
G. WAX-253.03	Silver Block - 1 lb.	3 ³ / ₁₆ " Square x 2 ³ / ₈ " Thick	\$14.45
H. WAX-255.01	Five Gold Slices - 1 lb.	3 ³ / ₁₆ " Square (various thickness)	\$14.45
WAX-255.03	Five Silver Slices - 1 lb.	3 ³ / ₁₆ " Square (various thickness)	\$14.45

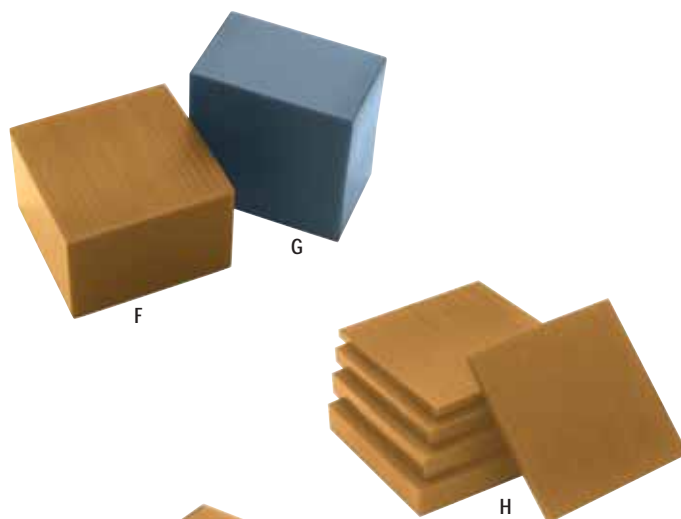

WOLF BUILD-UP/REPAIR WAX™

This durable repair wax makes it easy to blend built-up and repaired sections of Wolf's Gold or Silver Carving Wax. To insure a thorough bond, melt model where repair wax is to be added. Three ounce bar measures 1⁷/₁₆" square x 3⁵/₈" long.

Stock #	Description	Weight	
I. WAX-270.01	Gold Bar	3 oz.	\$7.95
J. WAX-270.03	Silver Bar	3 oz.	\$7.95

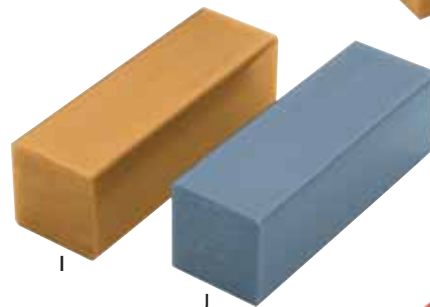

WOLF'S WICKED STICKY POSITIONING WAX

Ideal when securing stones for accurate tracing. Simply smear wax on stone then press it onto wax or metal then scribe around the stone. Measures 3¹/₁₆" square x 5" long. Flows at 173 °F (78 °C)

Stock #	Description	
K. WAX-275.05	3 oz. Box	\$8.95



WOLF RELIEF WAX™

Use for creating raised detail on carving waxes. Apply molten Relief Wax onto surface of the wax model. Can be easily carved. Flows at 165 °F (74 °C).

Stock #	Description	
L. WAX-281.05	1.7 oz. Tin	\$15.95



WOLF TOUCH-UP WAX™

Ideal for the final touch-up of wax imperfections such as pits, cracks or to flow inside bezel walls for a tighter fit. Can be easily scraped-off or trimmed for a smooth finish. Flows at 163 °F (73 °C).

Stock #	Description	
M. WAX-280.00	1.7 oz. Tin	\$15.95



Aqua Green Flakes

All-purpose detail wax. Also recommended for stone in place casting.



Turquoise Flakes

All-purpose detail wax. Also recommended for stone in place casting.

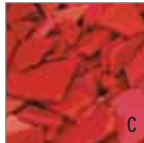

Ruby Red Flakes

All-purpose detail wax. Also recommended for stone in place casting.



Filigree Pink Flakes

Highest detail, easy removal without breakage. Recommended for stone in place casting.



Tuf Guy Green Flakes

Toughest wax. Accurate and durable, yet flexible. Ideal for large pieces.

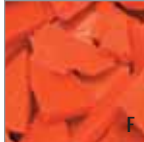

Super Pink Flakes

Has the quickest solidification. Ideal for bezel settings.



Flexide Blue Flakes

Longest shelf-life and highest flexibility. Well-suited for metal molds and stone in place casting.



Carvable Purple Flakes

Superior carvability with minimal filling or clogging of tools. Highest injection temperature means no breakage under stress and easier handling.



J



See our new wax cutting mandrel for ring tubes on pg. 49.

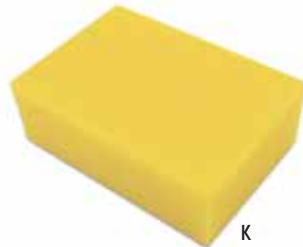

K

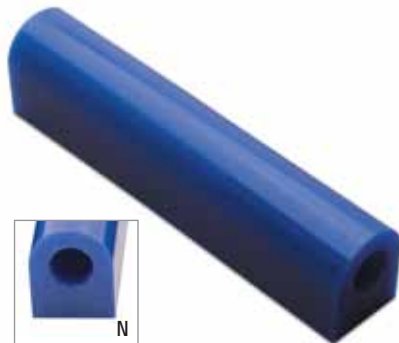

L



M

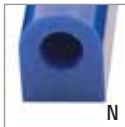

N



O

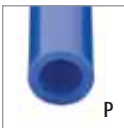

P



Q



R



S



T

Wax Ring Tubes available in Blue (Medium-Hard) or Dark Green (Hard).

FREEMAN FLAKES PREMIUM INJECTION WAX

For over 30 years, Freeman injection wax has been the industry standard for quality and consistency. Freeman formulations are renowned for their high pattern detail, rapid wax solidification, minimal shrinkage, excellent flow, and low ash content (.003%) enabling the cleanest burnouts and most accurate reproductions of alloys. All are designed for platinum, gold and silver, as well as industrial and dental alloys. Priced per pound. Packaged in bags with a case quantity of 10 or 50 lbs.

Stock #	Description	Injection Temp.	
A. WAX-300.10	Aqua Green Flakes	65°C / 150°F	\$7.85/lb
B. WAX-300.20	Turquoise Flakes	65°C / 150°F	\$7.85/lb
C. WAX-300.30	Ruby Red Flakes	65°C / 150°F	\$7.85/lb
D. WAX-300.40	Filigree Pink Flakes	68°C / 155°F	\$7.85/lb
E. WAX-300.50	Tuf Guy Green Flakes	73°C / 165°F	\$7.85/lb
F. WAX-300.60	Super Pink Flakes	65°C / 150°F	\$7.85/lb
G. WAX-300.70	Flexide Blue Flakes	68°C / 155°F	\$8.35/lb
H. WAX-300.80	Carvable Purple Flakes	77°C / 170°F	\$8.35/lb

FREEMAN CARVING WAX BLOCKS

A smooth, non-brittle wax designed for carving and/or machining. The softer light green wax is specifically formulated for easy hand carving. The blue (medium-hard) and dark green (hard) waxes can be either hand carved or machined to form intricate patterns.

Stock #	Description	Melting Temp.	Size	
WAX-331.10	Blue (Medium-Hard)	226°F / 108°C	1 lb. Block	\$14.95
I. WAX-331.20	Blue (Medium-Hard)	226°F / 108°C	1 lb. Assorted, Sliced	\$16.95
WAX-331.25	Blue (Medium-Hard)	226°F / 108°C	1/2 lb. Assorted, Sliced	\$12.95
WAX-332.10	Dark Green (Hard)	229°F / 110°C	1 lb. Block	\$14.95
J. WAX-332.20	Dark Green (Hard)	229°F / 110°C	1 lb. Assorted, Sliced	\$16.95
WAX-332.25	Dark Green (Hard)	229°F / 110°C	1/2 lb. Assorted, Sliced	\$12.95

SOL-U-CARV WAX

A carvable wax that is water soluble, making it ideal for use in lost wax casting, especially in the making of cores, hollow beads, or other pieces that feature hollow areas. Dissolves easily when immersed in water. Melts at 60°C/140°F.

Stock #	Description	
K. WAX-335.10	1 lb. Block	\$23.95

CARVING WAX RING TUBES

Carvable wax in ring tube forms are easy to cut for creating and designing rings. All tubes are 6" long with a 5/8" diameter shank allowing for many rings to be cut from each tube. Available in blue (medium-hard) and dark green (hard).

Blue	Description	Dimensions	
L. WAX-321.10	Small Flat Side Tube (FS-1)	1" x 1"	\$6.50
M. WAX-321.20	Medium Flat Side Tube (FS-3)	1" x 1 1/8"	\$6.50
N. WAX-321.30	Large Flat Side Tube (FS-5)	1 3/8" x 1 1/8"	\$6.50
O. WAX-321.40	Extra Large Flat Side Tube (FS-7)	1 3/8" x 1 1/4"	\$6.50
P. WAX-321.50	Small Round Center Hole Tube (RC-1)	7/8"	\$6.50
Q. WAX-321.60	Large Round Center Hole Tube (RC-3)	1 1/16"	\$6.50
R. WAX-321.70	Large Round Off-Center Hole Tube (ROC-3)	1 1/16"	\$6.50
S. WAX-321.80	Small Round Solid Bar (RS-1)	7/8"	\$6.50
T. WAX-321.90	Large Round Solid Bar (RS-3)	1 1/16"	\$6.50

Dark Green	Description	Dimensions	
WAX-322.10	Small Flat Side Tube (FS-1)	1" x 1"	\$6.50
WAX-322.20	Medium Flat Side Tube (FS-3)	1" x 1 1/8"	\$6.50
WAX-322.30	Large Flat Side Tube (FS-5)	1 3/8" x 1 1/8"	\$6.50
WAX-322.40	Extra Large Flat Side Tube (FS-7)	1 3/8" x 1 1/4"	\$6.50
WAX-322.50	Small Round Center Hole Tube (RC-1)	7/8"	\$6.50
WAX-322.60	Large Round Center Hole Tube (RC-3)	1 1/16"	\$6.50
WAX-322.70	Large Round Off-Center Hole Tube (ROC-3)	1 1/16"	\$6.50
WAX-322.80	Small Round Solid Bar (RS-1)	7/8"	\$6.50
WAX-322.90	Large Round Solid Bar (RS-3)	1 1/16"	\$6.50

A. FREEMAN CASTING SHEET WAX

Smooth, flexible and transparent, these thin wax sheets allow easy tracing, design and molding of free form shapes. Melts at 177°F/81°C. Each box contains 12 sheets measuring 6" x 6" (152mm x 152mm).

Stock #	Description	
WAX-340.18	18 Gauge (.101mm / .040")	\$16.95
WAX-340.20	20 Gauge (.81mm / .032")	\$16.35
WAX-340.22	22 Gauge (.65mm / .025")	\$16.35
WAX-340.24	24 Gauge (.51mm / .020")	\$16.35
WAX-340.26	26 Gauge (.40mm / .016")	\$16.35
WAX-340.28	28 Gauge (.30mm / .012")	\$16.35
WAX-340.30	30 Gauge (.25mm / .010")	\$16.35
WAX-340.32	32 Gauge (.20mm / .008")	\$16.35



B. SPRUE WAX

A wax that features ample flexibility and sufficient rigidity for sprueing and mounting a wax pattern. Specially formulated (145°F/63°C melting temp.) not just to hold patterns during the investing process, but also for easy elimination during burnout. Available in 8 oz. bulk boxes or convenient 1 oz. boxes.

Stock #	Description	Size	
WAX-310.06	6 Gauge / 4.12mm	1 oz. (28gram) box, 4" length	\$10.95
WAX-312.06	6 Gauge / 4.12mm	8 oz. box, 6¾" length	\$17.95
WAX-310.08	8 Gauge / 3.25mm	1 oz. (28gram) box, 4" length	\$10.95
WAX-312.08	8 Gauge / 3.25mm	8 oz. box, 6¾" length	\$17.95
WAX-310.10	10 Gauge / 2.60mm	1 oz. (28gram) box, 4" length	\$10.95
WAX-312.10	10 Gauge / 2.60mm	8 oz. box, 6¾" length	\$17.95
WAX-310.12	12 Gauge / 2.05mm	1 oz. (28gram) box, 4" length	\$10.95
WAX-310.14	14 Gauge / 1.63mm	1 oz. box, 6¾" length	\$10.95
WAX-312.04	¾" x 9.0mm	1 oz. box, 6¾" length	\$17.95

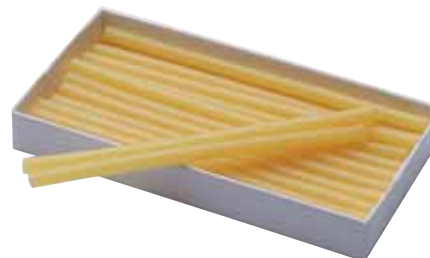

All Freeman Waxes
Made in USA.

C. PURPLE SPRUE WAX

Hardest sprue wax available. Each piece is 24" length with a choice of three diameters. 50 lb. box.

Stock #	Description	
WAX-315.20	¼" Dia. x 24"	\$399.00
WAX-315.30	⅜" Dia. x 24"	\$399.00
WAX-315.40	½" Dia. x 24"	\$399.00

D. WAX WIRE ASSORTMENTS

Wax wire assortments offer greater design versatility. Flexible wax wire can be used to create patterns or details by twisting or bending. Pieces are approximately 4" in length.

Stock #	Description	
WAX-350.01	Assortment No. 1 – Round/Half Round	\$19.95
WAX-350.02	Assortment No. 2 – Round	\$19.95
WAX-350.03	Assortment No. 3 – Rectangle/Square	\$19.95
WAX-350.04	Assortment No. 4 – Bezel	\$19.95
WAX-350.05	Assortment No. 5 – Triangle/Prong	\$19.95



E. WAX WIRE – ROUND

Box of round wax wire is offered in gauges 8 thru 20. Can be twisted or bent to desired shape. 2 oz. material.

Stock #	Description	Size	
WAX-355.08	8 Gauge Round	2 oz. Box	\$9.95
WAX-355.10	10 Gauge Round	2 oz. Box	\$9.95
WAX-355.12	12 Gauge Round	2 oz. Box	\$9.95
WAX-355.14	14 Gauge Round	2 oz. Box	\$9.95
WAX-355.16	16 Gauge Round	2 oz. Box	\$9.95
WAX-355.18	18 Gauge Round	2 oz. Box	\$9.95
WAX-355.20	20 Gauge Round	2 oz. Box	\$9.95



F. WAX WIRE SPOOLS – ROUND

Flexible wax wire on spools allows for less waste as the exact amount can be unwound as needed. Each spool contains a half pound of wax wires.

Stock #	Description	Size	
WAX-360.06	6 Gauge Round	½ lb. Spool	\$23.95
WAX-360.08	8 Gauge Round	½ lb. Spool	\$23.95
WAX-360.10	10 Gauge Round	½ lb. Spool	\$23.95
WAX-360.12	12 Gauge Round	½ lb. Spool	\$23.95
WAX-360.14	14 Gauge Round	½ lb. Spool	\$23.95
WAX-360.16	16 Gauge Round	½ lb. Spool	\$23.95
WAX-360.18	18 Gauge Round	½ lb. Spool	\$23.95
WAX-360.20	20 Gauge Round	½ lb. Spool	\$23.95



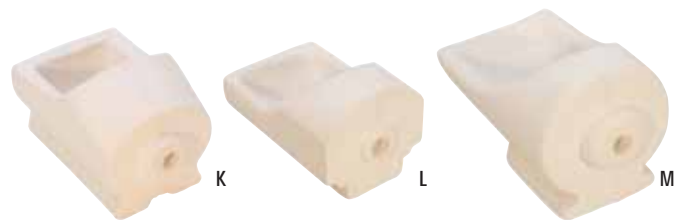

See our Gentec casting torches and torch accessories shown on page 197-200.



MELTING DISHES

Shallow ceramic melting dishes of fused silica for melting precious metals in temperatures up to 2,800 °F. Available in four sizes or as a set.

Stock #	Description	Size (dia x ht)	Capacity		
			(dwt)	(g)	
A. CAS-300.01	1 ³ / ₄ " Melting Dish	46 x 13mm	20	31	\$4.10
B. CAS-300.02	2 ¹ / ₄ " Melting Dish	60 x 17mm	40	62	\$4.50
C. CAS-300.03	3" Melting Dish	77 x 22mm	100	155	\$5.15
D. CAS-300.04	4" Melting Dish	96 x 30mm	175	271	\$6.05
CAS-304.00	Set of 4 (one each of above)				\$18.65

MELTING DISHES

For melting and easy pouring of metals such as gold, silver alloys etc. Made of fused silica with clay bond. Use with a torch for melting points up to 2,500 °F. High temperature melting dish (CAS-310.05) designed for use with platinum.

Stock #	Description	Size (dia x ht)	Capacity			
			(oz)	(dwt)	(g)	
E. CAS-310.01	Straight Side	70 x 39mm	7.5	150	233	\$7.85
F. CAS-310.05	High-Temp Straight Side	70 x 39mm	8	160	248	\$23.05
G. CAS-310.08	High Back	77 x 63mm	12	240	373	\$9.40

CENTRIFUGAL CASTING MACHINE CRUCIBLES

Replacement ceramic crucibles for centrifugal casting machines are made of fused silica with a clay bond. Suitable for melting temperatures up to 2500 °F.

Stock #	Description	Capacity			
		(oz)	(dwt)	(g)	
H. CAS-320.01	1.2 kg Casting Crucible 89 x 80 x 66mm	39	780	1.2kg	\$12.55
I. CAS-320.02	1.3 kg Casting Crucible 92 x 89 x 66mm	41	820	1.3kg	\$12.55
J. CAS-320.05	12 oz. w/o Slot (to fit Procraft Machines) 82 x 49 x 59mm	12	240	370	\$12.95
K. CAS-320.06	12 oz. w/ Slot (to fit Procraft Machines) 82 x 49 x 59mm	12	240	370	\$11.95
L. CAS-320.15	4 oz. Casting Crucible (to fit Kerr Machines) 73 x 45 x 45mm	4	80	125	\$12.55
M. CAS-320.18	9 oz. Casting Crucible (to fit Neycraft Machines) 102 x 58 x 64mm	9	180	280	\$13.75

GRAPHITE CRUCIBLES

Graphite crucibles for electric melting furnaces offered in several styles.

Stock #	Description	Capacity		
		(oz)	(dwt)	
N. CAS-330.05	1 kg Crucible (for Electric Furnaces) 65 x 125mm	32	643	\$21.95
O. CAS-330.06	2 kg Crucible (for Electric Furnaces) 75 x 160mm	64	1286	\$29.20
P. CAS-330.01	30 oz. Crucible (For Kerr Mini Melting Furnaces) 57 x 125mm	30	600	\$19.25
Q. CAS-330.02	100 oz. Crucible (For Kerr Maxi Melting Furnaces) 100 x 125mm	100	2000	\$33.55

NUCAST

A "space age" formula used in the melting process of casting to revitalize old scrap yellow gold. Eliminates porosity and pits. No flux needed. Allows casting at higher temperatures and gives old scrap gold new luster. Comes in shot form, packaged in a two ounce jar. Each jar contains enough product to cast approximately 800 dwt. of old gold.

Stock #	Description	
R. CAS-100.00	2 oz. Jar	\$39.95

"WHIP" - WIRE HANDLED INSTRUMENT FOR POURING

Another EURO TOOL exclusive invented by a jeweler, the WHIP makes a lot of sense when using small melting dishes. Made of stainless steel, the two sizes shown fit all of our melting dishes, 1 $\frac{3}{4}$ ", 2 $\frac{1}{4}$ ", 3" and 4". The spring action keeps good tension to assure the user that melting dishes will not slip. Sold individually or in sets. Total length is 9 $\frac{3}{4}$ ".

Stock #	Description	
A. CAS-250.01	Small WHIP only – Fits 1 $\frac{3}{4}$ " and 2 $\frac{1}{4}$ " dishes	\$7.95
B. CAS-250.02	Large WHIP only – Fits 3" and 4" dishes	\$8.95
CAS-250.98	Set of Two WHIPS (small and large)	\$16.80
CAS-250.10	Small WHIP with Two Dishes (includes 1 each 1 $\frac{3}{4}$ " and 2 $\frac{1}{4}$ " dish)	\$16.95
CAS-250.20	Large WHIP with Two Dishes (includes 1 each 3" and 4" dish)	\$20.95

New!

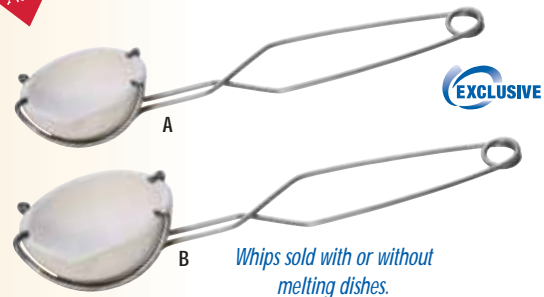

Whips sold with or without melting dishes.

FLASK TONGS

Our sturdy 16" flask tongs make retrieving hot flasks easy. Solid steel.

Stock #	Length	
C. CAS-230.00	16"	\$5.20

CRUCIBLE HOLDERS

Perfect for moving or pouring liquid metal from small crucibles, our stainless steel crucible pliers are box-jointed and very sturdy to handle metals securely. A total of 13" (330mm) long with PVC handle for a steady grip. You won't find a better way to hold crucibles than this.

Stock #	Length	
D. CAS-235.00	13"	\$19.95

CRUCIBLE HANDLE WITH MELTING DISH

EURO TOOL selected this crucible handle because it provides safety and assurance for the user. The shaft is steel, mounted into a hardwood handle secured by a steel pin so that after years of use around heat, there is no possibility that the handle will slip off. Moreover the shaft is heavier than others assuring a firm hold when transferring liquid metals. 19 $\frac{1}{4}$ " long supplied with a 3" 7.5 ounce capacity crucible.

Stock #	Description	
E. CAS-236.00	Handle with Crucible	\$17.95
CAS-236.01	Handle Only	\$11.55
CAS-310.01	Replacement Crucible	\$7.85

THREE PART MOLD FRAME - 7 IN 1

Made of high-grade aluminum, our three piece 7 in 1 mold frame offers the convenience of having a combination of seven mold frames at your disposal. Three frames which are securely held together with screws enable the user to make 1/2", 5/8", 3/4", 11/8", 1 1/4", 1 3/8" and 1 7/8" (13, 16, 19, 29, 32, 35.25 and 48mm) thick frames! This unit comes with extra screws which allow one to easily change the thickness. Save money, use the 7 in 1!

Stock #	Size	
F. CAS-169.00	1 $\frac{7}{8}$ " x 2 $\frac{1}{8}$ " (76 x 101mm)	\$36.95

PRIMO INGOT MOLD

Reversible two-in-one ingot mold. May be used to make flat stock or wire stock from scrap metal. Flat stock is 3" long by 2" wide by 1/8" thick. Wire sizes are 3" long by 2.5, 3.5, 4.5 and 6mm in diameter. Sturdy C-clamp holds both halves together tightly. Width of flat stock can be varied.

Stock #	Weight	
G. CAS-136.00	3 $\frac{1}{2}$ lbs.	\$33.95

SPRUE BASE HOLDER

Holds sprue bases 3 to 5 inches. Adjustable angles for different comfort positions. Portable or stationary base.

Stock #		
H. CAS-112.00		\$13.95

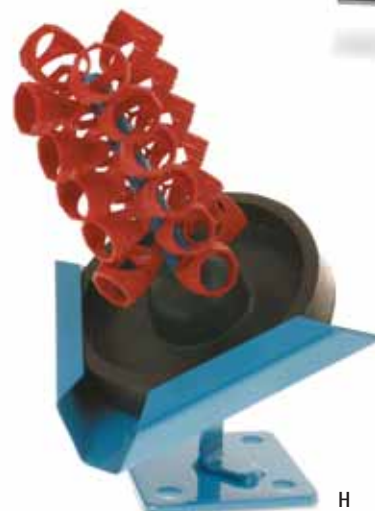



A



C

B



D



E

F

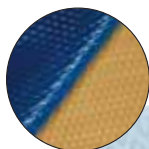

Flex: Soft, pliable, well-suited to delicate work and thicker molds. Yellow in color with dark blue polyethylene cover. Less than 3% shrinkage.

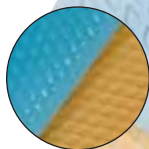

Firm: Preferred for thin molds and applications where extra firmness is required. Provides the best fine detail application. Yellow with light blue polyethylene cover. Less than 2% shrinkage.

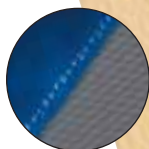

Super Low-Shrink Gray: Perfect for molds where extra firmness and extreme minimal shrink is required. Dark blue polyethylene cover.

A. RTV SILICONE™

RTV Silicone™ is a clear liquid two-part mold rubber system designed specifically for jewelry applications. It has the highest heat resistance available in a two-part liquid today. Zero shrink for accurate model reproduction. 24 hour room temperature or 30 minute accelerated cure option. Make production molds from original wax. Clear for easy bubble detection and parting line placement. Available in a 2.2 lb. kit, it is a 10 to 1 two-part mix.

Stock #	Description	
CAS-540.01	1.1 lb. Kit	\$35.95
CAS-540.02	2.2 lb. Kit	\$55.60
CAS-540.08	8.8 lb. Kit	\$199.95

SLICK™ MOLD RELEASE SPRAY

Silicone mold release spray for rubber molds is used to prevent broken patterns, saving time and frustration. Simply spray lightly on rubber mold before injecting wax. Non-toxic, non-hazardous, each can of Slick contains 590 ml of product making it very economical.

Stock #	Description	
B. CAS-128.00	590ml (20 fl. oz.)	\$8.95

FREEMAN CLEAR SILICONE

Freeman Clear Silicone is a two part component, room temperature vulcanizing (RTV) silicone rubber compound. Designed specifically for mold making, it is an ideal rubber for reproducing intricate detail and maintaining close tolerances. It features low viscosity for easy pouring and excellent clarity for ease of use and cutting visibility. It also features high tear strength and the ability to endure temperatures up to 350 °F. Advantages of silicone over urethane molds include: safer to work with, self-releasing, extreme shelf life, water clear, and can be heat accelerated to cut down on curing time.

Stock #	Description	
C. CAS-560.02	2.2 lb. Kit	\$71.90
CAS-560.08	8.8 lb. Kit	\$249.00

4X™ GOLD SILICONE MOLD RUBBER

4X™ Gold is a premium grade, soft Silicone Mold Rubber with amazing wax release and extreme high tear resistance and elongation properties. Intended to be used for very intricate designs, this premium rubber is designed for hand cutting method. 4X™ Gold produces an extraordinarily smooth, extremely high finish making it perfect for Platinum casting applications. Far less dense than other silicones on the market, making the mold yield per pound higher. 5 lb. box of 5/16" x 8" x 9" sheets.

Stock #	Qty	
D. CAS-542.05	5 lb. Box	\$53.00



E

JEWELRY RUBBER

Akron Natural Latex Jewelry Mold Rubber delivers controlled shrinkage, excellent cutting qualities, high tear resistance and elongation, and excellent fill and detail reproduction. Because our formulations contain certain waxes, oils and antioxidants, your molds will have many years of productive life. Available in flex, firm and low shrink in pre-cut pieces or strips. 5 lb. box.

Stock #	Description	Size	
E. CAS-520.05	Pre-Cut Mold Rubber – Flex	1/8" x 1 7/8" x 2 7/8"	\$32.25
CAS-521.05	Pre-Cut Mold Rubber – Firm	1/8" x 1 7/8" x 2 7/8"	\$32.25
CAS-522.05	Pre-Cut Mold Rubber – Gray	1/8" x 1 7/8" x 2 7/8"	\$42.00
F. CAS-530.05	Mold Rubber Strips – Flex	1/8" x 2 7/8" x 18"	\$32.25
CAS-531.05	Mold Rubber Strips – Firm	1/8" x 2 7/8" x 18"	\$32.25
CAS-532.05	Mold Rubber Strips – Gray	1/8" x 2 7/8" x 18"	\$39.00

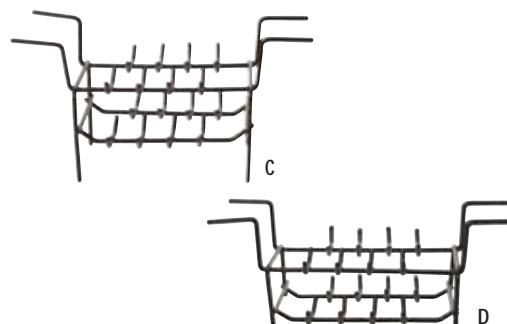
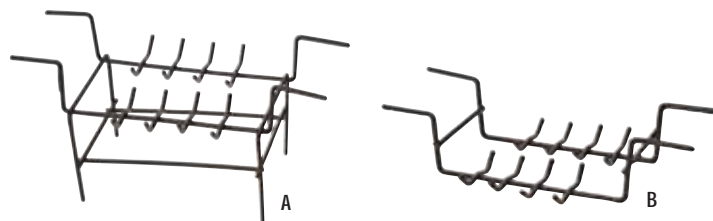

CLEANING RACKS

Wide selection of quality ultrasonic cleaning racks to fit every requirement. Racks have heavy PVC coating, double sided arms, and are available in hanging or standing models. Maximum size of ultrasonic tank that can be used with each rack is listed below.



Stock #	Description	# of Hooks	Size	
A. CLN-605.00	Standing	16	5" x 3 ¹ / ₄ " x 4"	\$3.95
B. CLN-608.00	Hanging	16	5" x 2 ³ / ₄ " x 1 ³ / ₄ "	\$3.25
C. CLN-605.50	Standing	32	5" x 3 ¹ / ₂ " x 4"	\$4.95
D. CLN-605.65	Hanging	32	5" x 3 ¹ / ₂ " x 3"	\$4.95
<i>(Please note: racks A-D fit 1 and 2 quart tanks lengthwise or 3,6, and 10 quart tanks crosswise)</i>				
E. CLN-606.00	Standing	64	9" x 3 ¹ / ₄ " x 4 ¹ / ₂ "	\$5.95
F. CLN-606.10	Hanging	64	9" x 3 ¹ / ₄ " x 3 ³ / ₄ "	\$5.95
<i>(Please note: racks E-F fit 3,6, and 10 quart tanks)</i>				

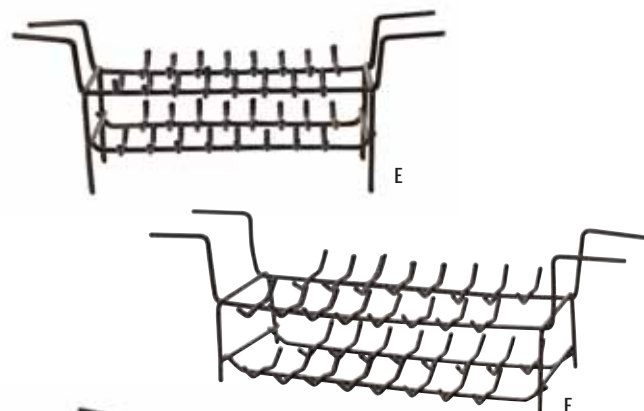

EXTRA WIDE CLEANING RACK

Our extra wide cleaning rack for rings gives the user more efficiency when cleaning rings, chains, etc. in the ultrasonic. Made to fit three to six quart units, this 5" wide rack is heavily coated PVC over thick wire and features 18 hooks from which to hang rings deep into the tank for thorough cleaning. This is another helpful cleaning aid developed by EURO TOOL.

Stock #	Description	Length	
G. CLN-602.00	18 Hooks	12 ³ / ₄ "	\$6.95



ULTRASONIC RING RACKS

Ultrasonic racks are excellent to suspend rings and bracelets into solution without damage to the metal or soft stones. Made of heavy gauge wire, with a thick protective coating, holds either 8 or 12 rings which are well submerged, but easy to retrieve.

Stock #	Description	Length	
H. CLN-603.00	12 Rung	12"	\$3.95
I. CLN-604.00	8 Rung	6 ¹ / ₂ "	\$3.25

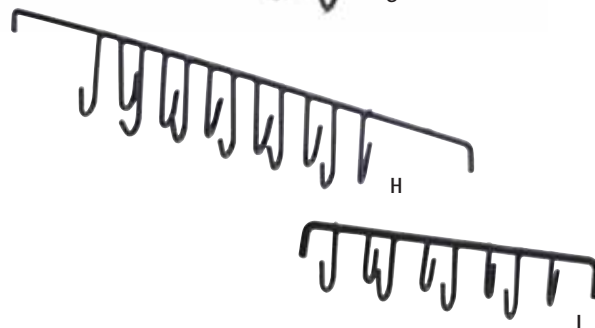

CLEANING RACK WITH MOVABLE HOOKS

Versatile cleaning racks with movable hooks are made of non-rust aluminum. The hooks are plastic and can be moved along the rack for the best positioning of items being cleaned. The neat part is that these cleaning racks fit all tanks! Great for chains, rings, etc. Replacement hooks also available.



Stock #	Description	Length	
J. CLN-609.08	8 Hook Rack	11 ³ / ₄ "	\$6.95
CLN-609.12	12 Hook Rack	14 ³ / ₄ "	\$8.98
K. CLN-609.01	Replacement Hook		\$1.00



Several small task baskets can be hung from any of our hanging cleaning racks. See page 60.

CLEANING RACK STAND

Our new stand is the perfect match to our ultrasonic ring racks. It allows the user to dry rings, chains, or other articles after rinsing. PVC coated so it won't rust, and designed to hold the ring rack securely while items drip dry. An excellent aid to keep your cleaning well-organized. 6" H x 4¹/₂" W x 10" L.

Stock #		
L. CLN-609.50		\$9.95



EXCLUSIVE**UNIVERSAL CLEANING BASKETS**

Our stainless steel cleaning baskets are universal, as they will fit virtually any ultrasonic unit. With practical side clips, they can be used with smaller ultrasonic units as well as larger ones. Easily fit two baskets into larger units allowing great flexibility.

Stock #	Description	Dimensions	
CLN-650.00	Standard Mesh	5" x 4" x 1 ³ / ₄ "	\$13.95
A. CLN-650.10	Fine Mesh	5" x 4" x 1 ³ / ₄ "	\$13.95
CLN-650.20	Extra-Fine Mesh	5" x 4" x 1 ³ / ₄ "	\$14.95

RECTANGULAR CLEANING BASKETS

Our line of economical baskets has expanded to include several new sizes. Made of stainless steel with stainless steel mesh, our baskets offer the user a size for every need. All are available in 1/4" standard mesh, fine and extra-fine mesh. Extra-fine mesh keeps meales and other small items from falling through to the bottom of your tank.



Standard mesh is great for general use and small items.

Order fine mesh baskets when cleaning small pieces of jewelry, findings, etc.

Extra-fine mesh holds the smallest of items and parts safely when cleaning.

Stock #	Description	Dimensions	
CLN-651.00	Standard Mesh	4" x 3" x 1 ¹ / ₂ "	\$14.75
B. CLN-651.10	Fine Mesh	4" x 3" x 1 ¹ / ₂ "	\$14.75
CLN-651.20	Extra-Fine Mesh	4" x 3" x 1 ¹ / ₂ "	\$14.75
C. CLN-652.10	Fine Mesh	5" x 4" x 3"	\$17.95
CLN-652.20	Extra-Fine Mesh	5" x 4" x 3"	\$17.95
D. CLN-653.10	Fine Mesh	8" x 4" x 3 ¹ / ₂ "	\$21.95
CLN-653.20	Extra-Fine Mesh	8" x 4" x 3 ¹ / ₂ "	\$21.95



E

Several small task baskets can be hung from any of our hanging cleaning racks (see page 59).



F

CLEANING BASKET

Available in two sizes. Perfect for holding small parts in your ultrasonic. Basket is brass with stainless steel mesh to hold the smallest screws and other miniature parts. Simply screw both halves together and clean small items with ease.

Stock #	Description	
E. CLN-634.00	5/8" Diameter	\$4.95
CLN-635.00	1" Diameter	\$5.95

SMALL TASK BASKET

Our ultrasonic task basket allows the user to confine small parts in the ultrasonic and retrieve them easily. Basket is mesh stainless steel to resist corrosion and drain easily. Available in two sizes to fit smaller to mid-size ultrasonic units. Several can be used at one time and can be hung from any of our hanging cleaning racks.

Stock #	Height	Diameter	
F. CLN-645.00	4"	2 ¹ / ₂ "	\$5.45
CLN-645.10	3 ¹ / ₂ "	2 ¹ / ₂ "	\$5.45

STEAMOSTATS

The original, perfect, non-scratch holder for steam and ultrasonic cleaning. Steamostats feature stainless steel box-joint construction, PVC covered non-scratching tips, and are available in locking or non-locking models. Locking version has a three-position lockable handle to prevent twisting and slipping. The large, easy-hold loop grips provide comfortable, secure usage. Excellent tool for steam cleaning rings and other jewelry as well as retrieving items from the bottom of your ultrasonic.

Stock #	Description	Length	
G. HEM-250.00	Locking	7 ¹ / ₂ "	\$6.25
H. HEM-255.00	Non-Locking	8"	\$7.45

STEAM TWEEZERS

Chrome plated steam tweezers with thick coating on tips holds items securely.

Stock #	Length	
I. TWZ-954.00	8"	\$4.95
J. TWZ-955.00	10"	\$5.50
K. TWZ-957.00	12"	\$5.95

**EURO TOOL® original**

PARTS HOLDING BASKETS

Our convenient parts holding baskets are perfect for ultrasonic or steam cleaning. The spring open/close action for quick unloading and the fine mesh screen keeps small parts together like nothing else can. Available in two sizes with metal handles or plastic handles which will not transfer heat. 18/8 stainless steel mesh.

Stock #	Handle	Basket Dia.	Length	
A. HOL-751.00	Metal	2 1/2"	7"	\$3.60
B. HOL-750.00	Metal	1 1/2"	6 1/2"	\$3.20
C. HOL-756.00	Plastic	2 1/2"	7 1/2"	\$3.90
D. HOL-755.50	Plastic	1 3/4"	7"	\$3.75
E. HOL-755.00	Plastic	1 1/2"	6 1/2"	\$3.45

"BEND-TO-FIT" BASKETS

Strainers with bendable metal handles which may be used for holding normally or can be bent as shown to hang onto the side of your favorite ultrasonic unit leaving hands free. Since the edge thickness varies on different ultrasonic units, we have opted to offer our bendable strainers in a straight form and let you do the bending. Simply hold the handle near the basket with a sturdy pair of pliers and shape to your liking. Two sizes available.



Stock #	Description	Basket Dia.	Length	
F. CLN-640.00	Small Basket	2 1/2"	6 3/4"	\$2.95
G. CLN-643.00	Large Basket	3"	7 1/4"	\$3.60

ULTRASONIC/STEAMER STRAINERS

Plastic strainers with nylon mesh are great for many uses. Nylon will not scratch jewelry and is perfect for dipping jewelry into the ultrasonic or holding it under a steam machine.

Stock #	Description	Basket Dia.	Length	
H. CLN-630.00	Small Basket	2 1/4"	7 1/2"	\$1.95
I. CLN-632.00	Large Basket	4"	9"	\$2.95

FITZALL NYLON MESH BASKETS

Probably one of the most practical ideas EURO TOOL has developed in a long time, our ultrasonic baskets simply cannot scratch precious jewelry! Priced right and made to do the job better, our baskets will never scratch or damage precious goods.

- Baskets are 100% plastic with fine nylon mesh.
- Nylon mesh will not allow small parts or stones to drop to the bottom of your ultrasonic unit.
- Our 4" x 2 3/4" x 2" basket with 6 1/4" handle features a flat end, with two 1 1/4" tabs, to fit onto the edge of virtually any unit. You can even put several across larger units.
- The larger basket is 4 1/2" x 3 1/2" x 2" deep with two arms. Fits two quart, three quart, and six quart units.
- Both baskets have holes in the handles for hanging when not in use. Baskets also "nest" for compact storage.

Stock #	Basket Dimensions	Total Length	
J. CLN-700.10	4" x 2 3/4" x 2"	11 3/4"	\$4.95
K. CLN-720.10	4 1/2" x 3 1/2" x 2"	9 1/4"	\$5.95

BEAKER HOLDER

Simple but very effective. Our new beaker holders allow the jeweler to place a 600ml beaker into an ultrasonic without fear of it spilling. Quite often jewelers wish to clean with extra strong solution. Using our new beaker holder makes good sense to avoid contamination when using a beaker. The holder is made of metal with a heavy PVC coating.



Stock #	
L. CLN-675.00	\$6.95



Nylon mesh securely keeps small parts in basket.





Each Ionic Cleaning Machine includes 16 oz. of Super Concentrate ionShine solution.



B C



Tank dimensions: 5 $\frac{3}{4}$ " W x 5 $\frac{1}{4}$ " D x 4" H
Overall dimensions: 7" W x 6 $\frac{1}{4}$ " D x 9 $\frac{3}{4}$ " H
Capacity: 2 Quart

Beaker holder shown sold on page 61.

New!

Tank dimensions: 5 $\frac{1}{2}$ " W x 4" D x 9" H
Overall dimensions: 6 $\frac{5}{8}$ " W x 11" D x 9 $\frac{1}{2}$ " H
Capacity: 3 Quart



E

Tank dimensions: 5 $\frac{3}{4}$ " W x 5 $\frac{1}{4}$ " D x 4" H
Overall dimensions: 7" W x 6 $\frac{1}{4}$ " D x 9 $\frac{3}{4}$ " H
Capacity: 2 Quart



Combines the best of both ultrasonic and ionic cleaning powers.

16 oz. Sparklemaster included with each Ionsonic Machine.



G H

Tank dimensions: 6" W x 3 $\frac{1}{2}$ " D x 2" H
Overall dimensions: 8" W x 5" D x 5 $\frac{1}{2}$ " H
Capacity: 600ml



I

IONIC CLEANING MACHINE

This improved performance ionic cleaner gives a whole new level of cleaning. Because the ionic system does not vibrate in any way, it is safe for softer stones including turquoise, opals, emeralds, and pearls. Removes oxidation and cleans gold, silver or platinum in seconds without leaving residue to tarnish. One year warranty.

Stock #	Capacity	
A. CLN-520.10	12 fl. oz.	\$84.95

IONSHINE IONIC CLEANER CONCENTRATE

Newly developed concentrate mixes two ounces to one quart of water to produce the best solution for use in our new ionShine cleaning unit, or any others for that matter. Leaves silver and other precious metals clean and shiny, without tarnish. Just rinse and wipe dry for a sparkling clean look. Safe for soft stones and pearls.

Stock #	Description	
B. CLN-845.05	16 oz. (Twin neck bottle)	\$9.95
C. CLN-845.10	32 oz.	\$10.95

ULTRASONIC CLEANING MACHINE - 2 QUART

The O.N.E. two quart ultrasonic cleaning machine is manufactured to the highest standards and with the latest technology to provide years of cleaning. 42khz of power/ 2 amp, 120 watts and pulsating hydrosonic technology for enhanced transducer life. Tank and lid are all stainless steel for easy trouble-free cleanup. Includes heater and timer. One year warranty. Made in USA.

Stock #	Capacity	Weight	
D. CLN-520.30	2 Quart	7 lbs.	\$199.99

ULTRASONIC CLEANING MACHINE - 3 QUART

Three quart HS3Q high performance unit with a full 120 watts of power and built-in heater. Advanced ultrasonic technology - industrial strength with commercial grade transducers. Stainless steel tank and lid with durable plastic chassis. Timer with continuous options. One year warranty. Made in USA.

Stock #	Capacity	Weight	
E. CLN-520.40	3 Quart	8 lbs.	\$299.99

IONSONIC MACHINE

This newly developed ionSonic machine is the result of research and a true breakthrough in the effective cleaning of jewelry. High tech but extremely practical, it offers the user both ultrasonic and ionic cleaning options. The ultrasonic option features a heater and 120 watts (2 amp) of cleaning power; the ionic cleaning is for soft stones and other fragile items. For unequaled cleaning, one can use both ionic and ultrasonic cleaning at the same time. Includes 16 oz. Sparklemaster concentrate. One year warranty.

Stock #	Capacity	Weight	
F. CLN-520.00	2 Quart	9 lbs.	\$299.95

SPARKLEMASTER IONSONIC CONCENTRATE

Sparklemaster is specially formulated for use with the revolutionary ionSonic cleaning system. This liquid concentrate is biodegradable and safe for all jewelry. Super concentrated formula makes Sparklemaster very economical - mix only 2 ounces in two quart tank. You will get incredible results and tarnish-free jewelry with a beautiful shine.

Stock #	Description	
G. CLN-835.05	16 oz. (Twin neck bottle)	\$11.99
H. CLN-835.10	32 oz.	\$18.99

ULTRASONIC CLEANING MACHINE

A true ultrasonic, this unit cleans quickly and efficiently. With 35 watts producing 42,000 cycles of cleaning power and solid state circuitry, this is an excellent machine for many applications. Stainless steel one-piece tank construction. The see-through lid is attached, making this unit extremely easy to load and unload. Includes a convenient plastic cleaning basket. Packed individually in styrofoam in an attractive corrugated box to arrive in good working order. 110-volt AC 50/60hz. 600ml capacity.

Stock #	Description	Weight	
I. CLN-520.20	Ultrasonic Cleaner	2.5 lbs.	\$49.95
CLN-520.25	Digital Ultrasonic Cleaner	2.5 lbs.	\$59.95



Exclusive from EURO TOOL! Our best cleaner and it's bio-friendly!

Mixes 30:1!



Try our Bend-To-Fit Ultrasonic Baskets – pg 61.



A

A. EUROSONIC CONCENTRATE CLEANER

EuroSonic concentrate exclusively from EURO TOOL is an advanced technology, bio-friendly ultrasonic cleaning solution containing thousands of enzymes which will remove body oils, debris, rouges and grime accumulations from metals, stones and other materials. You've seen biodegradable cleaners before which lack the cleaning power of good old ammonia. Trust us on this one, EuroSonic contains no phenols, ammonia, sulphur or nitrites and is non-toxic, biodegradable and requires no hazardous shipping. Our best cleaner – MSDS approved. Try it – it really works! MIXES 30 TO 1.

Stock #	Size	
CLN-850.01	Half-Pint (12 to a case)	\$3.65
CLN-850.10	Quart (6 to a case)	\$9.85
CLN-850.15	Gallon (2 to a case)	\$34.25

TIVACLEAN CLEANING CONCENTRATE

Tivaclean is an electrocleaning concentrate for both metals and plastics. An orange powder that, when mixed with water, (8 oz. to the gallon) changes to a fluorescent green to insure full rinsing, Tivaclean is biodegradable with no need to use toxic chlorinated solvents. In solution, Tivaclean has a non-caustic Ph of 9-10. Tivaclean is also a great ultrasonic cleaner. Can be used at room temperature, however, heating the solution to a temperature between 160° and 180°F enhances its performance.

Stock #	Description	
B. CLN-118.01	1 lb. Jar	\$7.50



B

POWERBRITE SUPER ULTRASONIC CONCENTRATE

A new formula that separates dirt, grime or polishing compounds from jewelry and deposits them at the bottom of your ultrasonic tank. Powerbrite contains no ammonia and normal mixture is 1:30, although it can be mixed stronger for tough compound removal. This product is fully V.O.C. compliant, releasing no harmful compounds into the atmosphere.

Stock #	Size	
C. CLN-870.15	One Gallon (4 to a case)	\$21.95



C

MAGIC GREEN POWDER CONCENTRATE

A revolutionary ultrasonic concentrate powder which, when mixed with water, forms an excellent cleaning concentrate which removes buffing rouge instantly and attacks tripoli within 45 seconds. One 32 ounce tub makes up to 32 gallons making it an outstanding value.

Stock #	Size	
D. CLN-120.02	32 oz. (12 to a case)	\$16.95
E. CLN-120.10	10 lb. (4 to a case)	\$72.00
CLN-120.50*	50 lb.	\$255.00

* additional shipping charge applies



D



E

MAGIC LUSTER

A major breakthrough in liquid ultrasonic cleaner! Magic Luster is a liquid super concentrate cleaner that is fast and long lasting. It cuts through rouge and tripoli in seconds. Magic Luster is a 40 to 1 mix ratio, so one gallon makes 40 gallons of ultrasonic liquid by simply adding water. Get four times more cleaning solution than the 10 to 1 products on the market at about the same price. Plus, there is no UPS surcharge for hazardous materials.

Stock #	Size	
F. CLN-130.00	One Gallon (4 to a case)	\$17.95



BLACK MAGIC PICKLE

This is a fantastic non-acid pickle for removing oxidation and firescale, which means no toxic fumes or corrosion on the work bench. Jewelers can use steel tweezers in the pickle pot. No more copper tweezers, no contaminating! And it will not hurt spring rings. Powder form makes one gallon when water is added. Non-hazardous to ship.

Stock #	Size	
G. CLN-160.00	Makes one gallon (6 to a case)	\$9.95



F



G

Introducing...

New!



A

See the difference!

ULTRA-POLISH PADS 

Fast and easy, these convenient sized Ultra-Polish Pads are great for removing tarnish, highlighting when using liver of sulfur or silver black, or polishing to a high luster. Leaves no residue. They are made of thin, tight-bond foam with permanently bonded micro-abrasives. A handy, economical polisher that is truly amazing. Sold in packs of 20.

Stock #	Description	Size	Qty.	
A. POL-695.00	Ultra-Polish Pads	2" x 2"	pk/20	\$6.50



B

B. QUIKBRITE

This cleaning solution is biodegradable, safe, fast and easy to use. Simply spray a mist of QuikBrite onto the object to be cleaned. Allow it to set one to two minutes and wipe off with a clean cotton cloth. This cleaner contains enzymes to remove all body oils, general debris and grime accumulated on all jewelry and stones. QuikBrite is organic in nature and is non-toxic. It contains no phenols, ammonia, sulphur compounds, nitrates or harmful components. Simple and quick, try it today! Sold by the case, priced per each.

Stock #	Size	
CLN-855.02	2 oz. Spray Bottle (12 to a Case)	\$1.39
CLN-855.04	4 oz. Spray Bottle (12 to a Case)	\$1.55
CLN-855.08	8 oz. Spray Bottle (12 to a Case)	\$1.96



C

EURO-SHINE

Euro-Shine is a specially formulated polishing cream which cleans, polishes and leaves a microscopic residue which keeps metals bright and protects from tarnish. Works on gold, silver, copper, brass, chrome, stainless steel and aluminum. Simply apply Euro-Shine with a damp cloth, then wipe off. Contains no acid and is gentle to the skin.

Stock #	Size	
C. POL-680.00	150 ml Tube	\$9.95



E

D

PR-88 HAND PROTECTANT

Another good idea. PR-88 is a wet compound, MSDS approved, which keeps grease and grime from penetrating the skin. Apply PR-88 before work begins - you won't even know you have it on, then just wash with soap and water when you're finished.

Stock #	Size	
D. CLN-800.03	3.5 oz.	\$7.95
E. CLN-800.10	1 Liter	\$31.50

Lintless cloths leave glass showcases and countertops spot free.



F

CLEAR REFLECTIONS GLASS AND SURFACE WIPE

Perfect for counter tops or virtually any smooth surface. Lint-free wipes contain a safe but potent cleaner which leaves glass spot-free, and eliminates overspray which is difficult to clean up. Each bucket contains 70 wipes.

Stock #	Size	
F. CLN-420.70	7.1" x 10.5" (18 x 26.7cm)	\$13.80



Extensive shelf life - will not dry out.

G

G. ROUGHTOUCH® WATERLESS HAND TOWELS

Roughtouch® Scrubs aren't really rough at all, but they do one heck of a job cleaning dirty hands. Made of a high-tech non-woven fiber, "Scrubs" are impregnated with a special non-hazardous chemical (MSDS approved) which removes grease, dirt or compound instantly. One side of the cloth is covered with a non-scratch abrasive to remove ground-in dirt, the other side for a final wipe. An amazing way to clean up in a hurry.

Stock #	Description	Towel Size	
CLN-423.10	One Multi-Pack of 10	9" x 11"	\$3.49
CLN-424.00	30 Count Bucket		
	(case of 6, 7.25 lb./case)	10 1/2" x 12 1/4"	\$42.95
CLN-424.10	30 Count Bucket	10 1/2" x 12 1/4"	\$8.18
CLN-425.00	72 Count Bucket		
	(case of 6, 17 lb./case)	10 1/2" x 12 1/4"	\$89.55
CLN-425.10	72 Count Bucket	10 1/2" x 12 1/4"	\$16.15

VELVET WAND

The Velvet Wand is the way to keep your displays and boxes looking clean and new. With its rounded corners and flexible shape, it can easily clean any surface shape and reach the corners of display cases, jewelry boxes, etc. One side for removing lint or dust, the other for de-pilling, and lifting the nap on crushed or matted fabrics. Reusable – simply pull fuzz off to clean and can be washed in cold water.

Stock #	Size	
A. POL-745.00	pk/3	\$9.00



SPECKGRABBER™

SpeckGrabber™ is a unique tool designed to remove individual contaminant particles from delicate and sensitive surfaces without damage or additional contamination. A small, soft, washable pad on the SpeckGrabber™ provides a high adhesion surface that particles stick to. Non-conductive and leaves no residue on the contacted surface. When tips become dirty, they can be cleaned with mild soap and water to restore tack. SpeckGrabber™ Pro model has a heavy-duty rubberized grip. Both models packaged in handy storage tube.

Stock #	Description	
B. CLN-905.00	SpeckGrabber™	\$5.95
C. CLN-905.10	SpeckGrabber™ Pro	\$12.95



CLEAN SWABS

Made in Switzerland, these high quality swabs are ideal for precision cleaning and applicator needs for the watch and clock industry or where a lintless applicator is required. Available in packs of 12 or swab assortment.

SEALED FOAM SWABS

Economical general purpose swabs. The open cell structure gives the best solvent holding ability of any style swab. Free of adhesives or binders that could contaminate your process. Fiberless construction guarantees particle free.

SEALED POLYESTER SWABS

Very clean and durable all-purpose swabs. These swabs are acid and solvent resistant and are ideal for tough scrubbing around raised shapes or delicate cleaning applications.

WRAPPED FOAM SWABS

Durable wrapped foam swabs designed for precise applications. Wrapped foam delivers superior abrasion resistance for removal of tough contaminants. Wicking action pulls solvent from surfaces. The small tip allows use in very tight tolerance areas, while the pointed end works as a pick.

Stock #	Description	
CLN-912.00	12pc Assortment, (3 ea style)	\$5.75
D. CLN-907.01	Sealed Foam Swabs, Bg/12	\$5.30
E. CLN-907.02	Sealed Foam Swabs – Pointed, Bg/12	\$5.30
F. CLN-908.01	Sealed Polyester Swabs – Round Tip, Bg/12	\$5.30
G. CLN-909.01	Wrapped Foam Swabs – Double-Ended, Bg/12	\$6.25

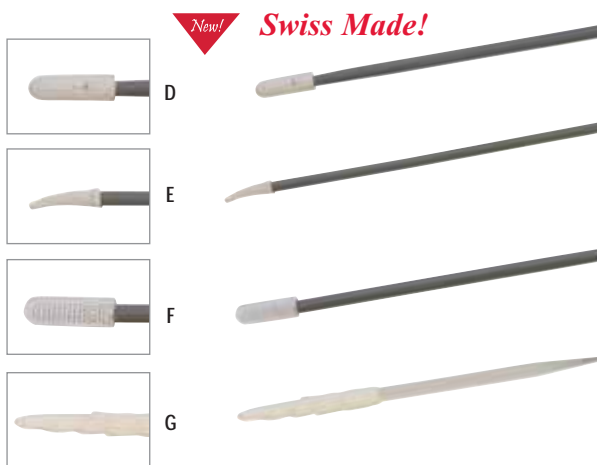

JEWELER'S CLEANING KIT

Whether you're showing an intricate piece or a single diamond, the tools in this kit will make sure it is presented dust-free! Jewelers and Gemologists Static and Dust Cleaning Kit contains unique tools for removing dust, lint and specks from diamonds, jewelry, watches, microscope lenses, loupes and appraisal cameras. Kit includes: anti-static microfiber cloth, StaticWisk™ anti-static brush for cleaning hard-to-reach places, precision cleaning solution, and the unique SpeckGrabber™ tool to pick up tiny particles off jewels, watch dials, crystals and other sensitive surfaces without leaving residue. All items packed in durable plastic storage box.

Stock #		
H. CLN-920.00		\$23.95



Portable, easy to store Jeweler's Cleaning Kit has everything needed to remove dust and lint from diamonds and jewelry.

PRECISION CLEANING SOLUTION

This alcohol based solution has been formulated to dissolve oils, fingerprints, organic and inorganic surface contaminants that can accumulate on surfaces. Effectively cleans all optics, plastics, glass, view finders, crystals and jewelry. This solution is quick-drying, kills germs and inhibits bacterial growth.

Stock #	Size	
I. CLN-901.00	1 oz. Bottle	\$4.00



"DIAMOND SUPREME" DIAMOND POINTS

Diamond points are instruments with diamond particles electroplated onto stainless steel. Our quality is unequalled, and each one shown features a 3/32" stainless steel shaft. Each instrument is a total of 13/4" (44.5mm) in length – the same as standard burs. Excellent for stone carving, cleanup work, glass, ceramics and metals. Available in medium-fine (120-140) and coarse (80) grit. We offer several sets to choose from, or points may be ordered individually. Always use water or a diamond lubricant when using diamond instruments of any kind. Our diamond instruments are premium professional grade, manufactured to last many times the life of cheaper diamond points. Don't be misled by cheap imitations which will, in the end, cost you more.

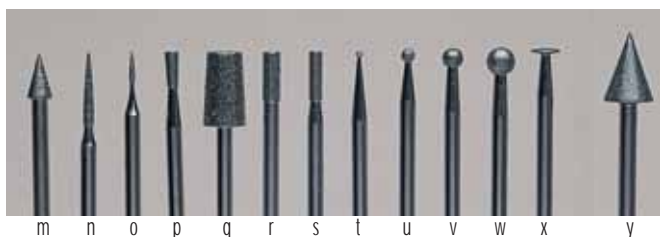

Always use a lubricant or water when working with diamond coated instruments.



Dia. x Length (mm)	Med.-Fine Grit		Coarse Grit	
	Stock #	Price	Stock #	Price
a. 2 x 1.5	DIB-100.02	\$4.31	DIB-100.12	\$5.37
b. 2.7 x 1.5	DIB-100.03	\$4.31	DIB-100.13	\$5.37
c. 4 x 1.5	DIB-100.04	\$4.83	DIB-100.14	\$6.05
d. 6 x 2	DIB-100.06	\$6.43	DIB-100.16	\$8.04
e. 1.5 x 4	DIB-110.01	\$4.31	DIB-110.11	\$5.37
f. 2 x 8	DIB-120.02	\$4.31	DIB-120.12	\$5.37
g. 3 x 11	DIB-120.03	\$5.18	DIB-120.13	\$6.46
h. 7 x 12	DIB-125.07	\$13.11	DIB-125.17	\$16.37
i. 6 x 8	DIB-130.06	\$9.01	DIB-130.16	\$11.27
j. 1.5 x 10	DIB-135.01	\$4.31	DIB-135.11	\$5.37
k. 2 x 12	DIB-135.02	\$4.31	DIB-135.12	\$5.37
l. 3 x 12	DIB-135.03	\$5.18	DIB-135.13	\$6.46
m. 3.5 x 6	DIB-140.03	\$6.43	DIB-140.13	\$8.04
n. 1.5 x 10	DIB-145.01	\$4.31	DIB-145.11	\$5.37
o. 0.9 x 4	DIB-145.00	\$4.31	DIB-145.10	\$5.37
p. 2 x 5	DIB-150.02	\$4.31	DIB-150.12	\$5.37
q. 6 x 10	DIB-120.06	\$9.01	DIB-120.16	\$11.27
r. 2.5 x 7	DIB-130.03	\$4.88	DIB-130.13	\$6.11
s. 2 x 7	DIB-130.02	\$4.88	DIB-130.12	\$6.11
t. 1 x 1	DIB-155.01	\$4.31	DIB-155.11	\$5.37
u. 2 x 2	DIB-155.02	\$4.31	DIB-155.12	\$5.37
v. 3 x 3	DIB-155.03	\$4.83	DIB-155.13	\$6.05
w. 4 x 4	DIB-155.04	\$5.56	DIB-155.14	\$6.96
x. 4 x 0.8	DIB-160.04	\$4.83	DIB-160.14	\$6.05
y. 6 x 9	DIB-170.00	\$12.47	DIB-170.10	\$15.56



Diamond Supreme Sets available in easy-to-store pouch or convenient wood stand!

B

A DIAMOND SUPREME SETS

Our 12 piece sets are available in a reusable, easy-to-store pouch or wood stand which offers great bench top convenience.

Stock #	Description	Price
DIB-212.01	12 pc Set In Pouch (1 each a-l, med-fine grit, listed above)	\$55.23
A. DIB-212.02	12 pc Set In Pouch (1 each m-x, med-fine grit, listed above)	\$49.66
B. DIB-213.01	12 pc Set In Wood Stand (1 each a-l, med-fine grit, listed above)	\$56.23
DIB-213.02	12 pc Set In Wood Stand (1 each m-x, med-fine grit, listed above)	\$50.66

**LARGE BULLET DIAMOND BURS**

Two lengths, one 4mm and the other 6mm, available in both medium and coarse grit for general use. Bullet burs are extra handy for a multitude of jobs. They feature 3/32" stainless steel shanks and top quality diamond electroplating. Use with water or diamond lubricant.

Stock #	Dia. x Length	Grit	Price
C. DIB-145.04	4mm x 10mm	Medium	\$7.92
D. DIB-145.06	6mm x 17mm	Medium	\$14.30
E. DIB-145.14	4mm x 10mm	Coarse	\$8.35
F. DIB-145.16	6mm x 17mm	Coarse	\$16.23

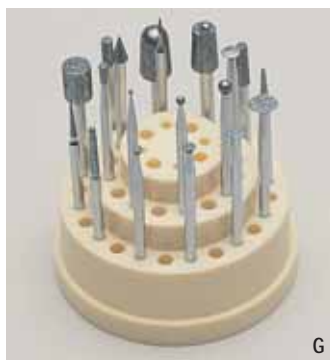

G

20 PIECE MASTER DIAMOND SET

Master Diamond Point set includes twenty of the most popular point shapes. Packaged in plastic stand with clear, domed lid to keep burs in place.

Stock #	Description	Price
G. DIB-220.00	20 pc Master Set	\$87.48

A. MINI HIGH-SPEED DIAMOND POINTS

For use in high-speed air driven turbo handpieces with a range up to 80,000 RPM. The quality is excellent, with diamond particles electroplated onto surgical-grade stainless steel. Shanks are 1.6mm (1/16") in diameter, with an average length of 20mm (3/4").

Stock #	Description	Grit	
DIB-700.00	Set of 24	Coarse	\$53.95
DIB-700.01	Set of 12 (components noted with *)	Coarse	\$26.95
DIB-700.50	Set of 24	Fine	\$53.95
DIB-700.51	Set of 12 (components noted with *)	Fine	\$26.95
Individual Points	(sold per piece, packaged in boxes of six)		\$2.65

Individual Points			
	Coarse(80)	Fine(120/140)	
a.	DIB-701.00	DIB-701.50	m. DIB-715.00
b.	DIB-701.01	DIB-701.51	n. DIB-716.00
c.	DIB-703.02	DIB-703.52	o. DIB-716.01
d.	DIB-705.00	DIB-705.50	p. DIB-717.00
e.	DIB-707.00	DIB-707.50	q. DIB-718.00
f.	DIB-708.01	DIB-708.51	r. DIB-718.01
g.	DIB-708.04	DIB-708.54	s. DIB-718.02
h.	DIB-708.05	DIB-708.55	t. DIB-718.03
i.	DIB-710.07	DIB-710.57	u. DIB-720.02
J.	DIB-712.01	DIB-712.51	v. DIB-722.00
k.	DIB-712.03	DIB-712.53	w. DIB-723.02
l.	DIB-714.00	DIB-714.50	x. DIB-724.01

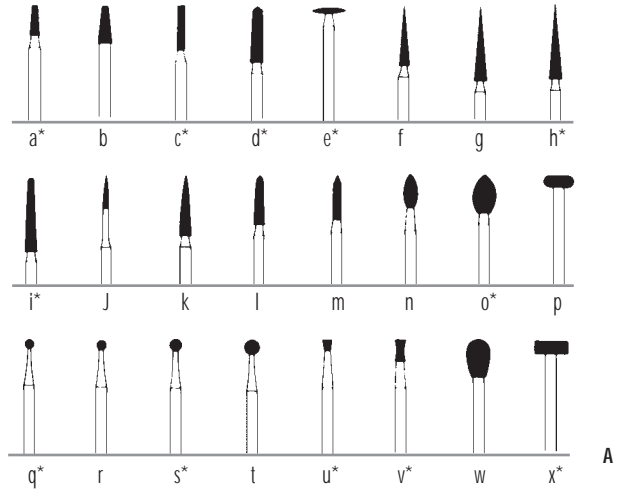

* Indicates components of 12 piece sets

B. SUPREME DIAMOND WHEELS - DELUXE QUALITY

Diamond wheels are used for grinding, cutting and texturing. Our quality diamond wheels are durable and will withstand high speed for extended periods of time. Use our miniature mandrel (BRS-275.00) with the unmounted wheels. Mounted wheels are permanently set on a 3/32" mandrel.

Stock #	Description	Size	
DIB-180.10	Mounted	1/2" x 0.6mm	\$8.55
DIB-180.20	Mounted	3/4" x 3.5mm	\$16.23
DIB-180.30	Unmounted	1" x 0.5mm	\$20.34
DIB-180.40	Unmounted	1" x 0.4mm	\$16.73
DIB-180.50	Mounted	5/8" x 2.5mm	\$13.37
DIB-180.60	Unmounted	1" x 0.5mm	\$17.73

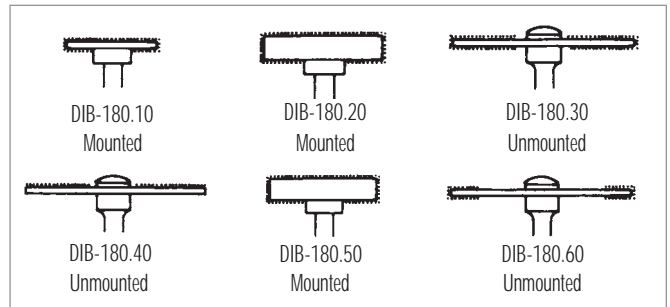

B

20 PIECE ECONOMY DIAMOND BIT SET

This diamond bit set is a good value for the novice or hobbyist. Several shapes and sizes in a handy plastic organizer. Can be used on ceramic, glass or stones. Available in either 3/32" or 1/8" shanks and all are the standard 44.5mm in length. Fine/medium grit.

Stock #	Description	
C. DIB-224.00	Set of 20 with 1/8" Shanks	\$8.45
DIB-225.00	Set of 20 with 3/32" Shanks	\$8.45



20 Piece Diamond Bit Set can be used on ceramic, glass or stone.

C

DIAMOND DISCS - ECONOMY

Another "value engineered" product, the 3/4" diamond discs mount on 3/32" mandrels (BRS-275.00). Thin, with electroplated diamond (medium grit) on both sides, discs are excellent for smoothing or sawing glass, stone or ceramics. Water or diamond lube should be used with these and all diamond instruments.

Stock #	Description	
D. DIB-225.01	3/4" Unmounted Diamond Disc	\$3.35



D

5 PIECE DIAMOND DISC SET

Five diamond discs, all medium grit for cutting or sanding stones and glass. This kit comes with an 1/8" mandrel. All discs are 0.033" (.84mm) thick and 13/16" (20.25mm) in diameter with diamond electroplated onto both sides. Discs will also fit perfectly onto a standard 3/32" mandrel.

Stock #	Description	
E. DIB-226.00	5 pc Set with Mandrel	\$14.05



E



Try our 412 Slick Lube with all of your Diamond Instruments for faster cutting and longer tool life. See page 37 for more information.



POCKET DIAMOND NEEDLE FILE SETS

Pen sized aluminum holder/handle with 3/8" diameter anodized barrel and pocket clip holds 5 1/2" diamond needle files with shortened shanks that are stored in the barrel. Handle has non-slip finger grip surface for positive control. An easy, convenient way to keep these files at your finger tips.

Stock #	Description	
A. FIL-671.00	Set of 3 (Includes: Flat, Three-Square, Half-Round)	\$16.95
FIL-673.00	Set of 5 (Includes: Flat, Three-Square, Half-Round, Square, Round)	\$19.95

DIAMOND-COATED NEEDLE FILES

The finest steel, milled to perfection with a diamond coating makes this range of files the best for precision filing jobs. Longevity is assured, as the diamond particles are electroplated onto the surface of the metal. Sold as a set or individually.

Stock #	Description	
B. FIL-965.00	Set of 5	\$45.60

Individual File	Shape	Overall Length	Cutting Length	
FIL-600.20	Pillar	5 1/2"	2"	\$8.95
FIL-605.20	Three Square	5 1/2"	2"	\$8.95
FIL-610.20	Half-Round	5 1/2"	2"	\$8.95
FIL-615.20	Square	5 1/2"	2"	\$8.95
FIL-620.20	Round	5 1/2"	2"	\$8.95

DIAMOND NEEDLE FILE SETS

Economy diamond needle file sets of five or ten pieces. All are 5 1/2" (140mm) long with medium grit diamond electroplated onto high-grade steel.

Stock #	Description	
FIL-970.00	Set of 5 (Includes: Round, Half-Round, Flat, Three-Square, Square)	\$11.50
C. FIL-972.00	Set of 10 (Includes: Round, Half-Round, Flat, Three-Square, Square, Warding, Slitting, Oval, Knife, Barrette)	\$24.15

4" PRECISION DIAMOND NEEDLE FILE SET

Economy diamond needle file set of ten pieces. All are 4" (100mm) long with fine grit diamond electroplated onto high-grade stainless steel. Set includes: round, half-round, flat, three-square, square, warding, slitting, oval, knife, and barrette.

Stock #	Description	
D. FIL-974.00	4" Diamond Needle File Set of 10	\$12.95

E. DIAMOND SAWBLADES

We offer you another quality engineered product: our diamond-coated sawblades. Made by electroplating diamond particles onto piano wire, our diamond blades are the best quality available at prices well below the competition. Our manufacturer offers a generous supply of diamond for long life and quick cutting. Blades come individually packaged and are 5 3/8" long to fit existing sawframes. Great for glass, ceramic and stones. Other grits available upon request.

Stock #	Description	
SAW-270.60	60 Grit (Coarse)	\$8.95
SAW-271.00	100 Grit (Medium/Coarse)	\$8.95
SAW-271.20	120 Grit (Medium)	\$8.95
SAW-271.40	140 Grit (Medium/Fine)	\$8.95

DIAMOND-COATED BEAD REAMER SET

Our handy bead reamer set is an excellent tool for bead stringers. One diamond instrument is long and sharp for reaming bead holes. The other is a 45° point for rounding off the edges of holes so that they do not cut through bead cord. Both are set securely in hardwood handles. This will be a great addition to any toolbox. The separate components are also available individually. Water should be used as a lubricant when using diamond-coated instruments. Length 4 1/2".

Stock #	Description	
DIB-270.01	Bead Reamer Set (2 pc)	\$8.95
F. DIB-261.05	Reaming Point with Hardwood Handle	\$4.45
G. DIB-271.50	45° Edging Point with Hardwood Handle	\$4.45

DELUXE THREE PIECE DIAMOND BEAD REAMER SET

The Diamond Bead Reamer Set, exclusively from EURO TOOL features three points and a 4 1/2" hollow handle in which to store them. You'll find the Diamond Bead Reamer set to be versatile, easier to use and trouble free. Made in USA. Features include:

- Three diamond tips: small and large reaming tips plus 45° edge reamer. Also available separately a steel cone reamer for metal beads.
- Easy release chuck friction fitted into the aluminum housing which releases instantly when the collet is unscrewed.
- Anodized aluminum handle; brass chuck so rust is never a problem.

Stock #	Description	
A. DIB-274.00	Three Piece Set w/ Comfort Grip Handle	\$15.95
B. DIB-275.00	Three Piece Set	\$14.95
DIB-275.01	Three Piece Tip Set (Includes C-E listed below)	\$5.95
DIB-275.02	Four Piece Tip Set (Includes C-F listed below)	\$6.95
C. DIB-275.55	Large Diamond Reamer	\$2.45
D. DIB-275.05	Small Diamond Reamer	\$1.85
E. DIB-275.50	45° Diamond Edging Point	\$1.65
F. DIB-275.40	Steel Cone Bur Reamer for Metal Beads	\$1.65



CORDLESS BEAD REAMER

The cordless bead reamer is a great tool to smooth and enlarge bead holes. Light weight and easy to use, it comes with 3 tips, small pointed, 45° edger and large pointed reamer. With a comfortable molded handle, and at 10,000 RPM's, bead reaming is made easy. This unit is powered by 2 AA batteries (not included). Packaged retail ready in a clear, compact hang-up blister with card. Always wear safety glasses when using this tool.

Stock #	Description	
G. HDP-380.00	Cordless Bead Reamer	\$11.95



MOTORIZED BEAD REAMER

A revolutionary tool for the beading industry. Motorized Bead Reamer with chuck accommodates 1/8" shank diamond points. With a motor which goes to 15,500 RPM, the speed is adjustable by a switch on the AC adapter. The body of this handpiece is lightweight and only 1 1/8" in diameter making it comfortable to hold while working. Includes three diamond points: Small Point (DIB-275.05), 45° Edger (DIB-275.50) and Large Diamond Reamer (DIB-275.55). Always use safety glasses when using this tool.

Stock #	Description	
H. HDP-375.00	Three Piece Motorized Bead Reamer Set	\$39.95
HDP-375.50	Handpiece Only	\$35.95



I. DIAMOND FLYWHEELS

American-made diamond flywheels are precision manufactured for bright cutting gold and other precious metals. Flywheels are constructed with a high-grade industrial diamond chip. This is a delicate tool for professional jewelers. Due to the nature of this tool, the manufacturer does not offer a warranty. Made in USA.

Stock #	Description	Length	
FLY-100.90	90°, 4mm Shaft	1 1/4"	\$69.45
FLY-101.20	120°, 4mm Shaft	1 1/4"	\$69.45
FLY-101.30	130°, 4mm Shaft	1 1/4"	\$69.45
FLY-101.50	150°, 4mm Shaft	1 1/4"	\$69.45
FLY-101.80	180°, 4mm Shaft	1 1/4"	\$69.45
FLY-200.90	90°, 3mm Shaft	1 1/4"	\$69.45
FLY-201.20	120°, 3mm Shaft	1 1/4"	\$69.45
FLY-201.30	130°, 3mm Shaft	1 1/4"	\$69.45
FLY-201.50	150°, 3mm Shaft	1 1/4"	\$69.45
FLY-201.80	180°, 3mm Shaft	1 1/4"	\$69.45

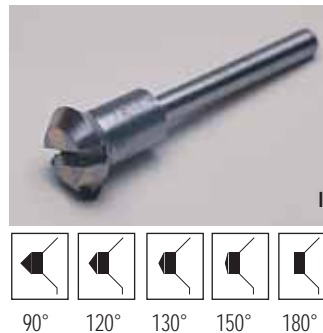

PAVÉTRON

Create exciting jewelry with an extra flair. Pavétron gives you the "Pavé" finish with minimum effort and no learning time required. Hammer action of this diamond tipped tool adds a luxurious texture and sparkle to gold and silver jewelry. Fits all hammer handpieces. Diamond cutting head gives the perfect cut. Made in USA.

Stock #	Length	
J. DIB-300.00	1 1/16"	\$23.45



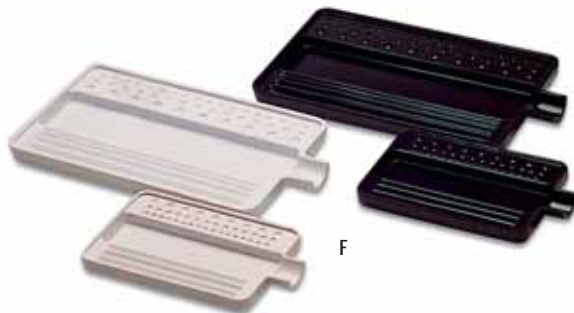

DELUXE DIAMOND/STONE SHOVELS with HANDLES

The best of both worlds – EURO TOOL exclusively offers the popular square shovels with an added handle securely attached. Chrome-plated and excellent for handling diamonds, pearls, and other stones of all shapes and sizes. Beveled lip makes picking up meles easy, and perfect for scooping up metal particles on the bench.

Stock #	Description	Size	
DIA-255.00	Small Deluxe Square Shovel	1½" x 2¼"	\$2.25
A. DIA-256.00	Large Deluxe Square Shovel	2 x 2½"	\$2.25

DIAMOND and STONE SHOVELS

Our chrome-plated shovels are excellent for handling stones of all shapes and sizes.

Stock #	Description	Size	
B. DIA-252.00	Shovel with Loop Handle	1½" x 2¼"	\$2.35
C. DIA-253.00	Square Shovel	2½" x 3½"	\$1.50
DIA-253.10	Square Shovel	1¾" x 2½"	\$1.45
D. DIA-254.00	Mini Square Shovel	1" x 1¼"	\$2.55

BEAD/STONE SCOOP

The most efficient scoop yet made, this EURO TOOL exclusive can scoop beads of all sizes, then with a twist of the wrist one can pour them into bottles or boxes or onto beading trays. This scoop can be used right or left handed. Made of nickel plated copper.

Stock #	Description	Size	
E. DIA-262.00	Bead/Stone Scoop	6½"	\$6.95

F. SORTING TRAYS

Trays for sorting diamonds, pearls, or gemstones. All trays feature indentations, grooves and a pour spout to make sorting easy and quick.

Stock #	Description	Size	
TRA-120.01	Small Black Tray	4½" x 2½"	\$2.65
TRA-120.02	Small White Tray	4½" x 2½"	\$2.65
TRA-220.01	Large Black Tray	7½" x 3¾"	\$4.95
TRA-220.02	Large White Tray	7½" x 3¾"	\$4.95

BEAD SCOOP

A EURO TOOL original, this large scoop makes counting and sorting beads easy. One end is flat for scooping beads, the other long and thin for dispensing beads one at a time. Bead scoop is 6" long, flat lip is 2¼". Made of nickel-plated brass.

Stock #		
G. DIA-260.00		\$5.85

DIAMOND SIEVES

Our high-quality sieves are made for sorting rough or polished stones and come with 22 or 42 plates. Each sieve comes in its own zippered leather pouch.

Stock #	Hole Sizes	Plate Diameter	No. of Plates	
H. DIA-333.00	000 to 20	1⅞" (47mm)	23	\$49.95
DIA-335.00	000 to 20 (1/2 sizes)	2⅞" (66mm)	43	\$89.95

I. GEM PAPER TRAYS

Our ultra white paper trays come flat and are scored for easy folding. High quality and a true white makes them perfect for sorting and grading diamonds or other gemstones. Sold in packs of 25.

Stock #	Description	Size	Qty.	
DIA-308.00	Small Paper Tray	2¾"	pk/25	\$4.55
DIA-309.00	Large Paper Tray	5"	pk/25	\$6.25

New!

Kits are a Hit!



JEWELERS HAND TOOL SET

The essential jewelers hand tools needed for jewelry making are included in this money saving kit. Includes one each of the following unless otherwise noted:

- Jeweler's Saw
- Burnisher
- Shears
- Butane Torch
- Polishing Cloth
- Pin Vise
- Round Nose Pliers 5"
- Sidecutters 5"
- Chain Nose Pliers 5"
- Third Hand
- 1 dozen Cut 0 Saw Blades
- 1 set half-round Sanding Sticks
- Dividers 4"
- Needle File Handle
- Soldering Board
- Scribe
- Silver Solder
- Bench Knife
- Half Round Medium Cut File
- AA Fine Tweezers
- Ring Mandrel
- Ring Clamp
- Locking Tweezers
- Ball Pein Hammer
- Wood Dapping Block & Punches
- 6pc File Set
- Tool Box

Stock #

KIT-100.10

\$199.00

GEM KIT

The Gem Kit is a classy way to offer many of the tools needed to measure, handle and examine gemstones. The contents are packaged in a kidskin leather pouch made for the purpose of holding gemstones. The set includes:

- Leather Box
- 25 White Diamond Papers
- Italian Diamond Tweezer with Groove
- 4-Prong Gem Holder
- Polishing Cloth
- Nylon Loupe Chain
- Brass Millimeter Gauge
- Small Gem Tray
- Stone Gauge
- 10X Triplet Loupe

This is a great gift idea too!

Stock #

KIT-120.10

\$59.95



PROFESSIONAL PEARL/BEAD STRINGING KIT

Professional Pearl/Bead Stringing Kit (includes instructional DVD). This extensive kit includes items specifically needed for stringing and knotting for the experienced and professional level. The kit includes:

- Original Bead crimping pliers
- Flocked bead board
- Thread scissors
- Brass mm gauge
- Deluxe bead reamer set
- Carrying tote
- Stringing needles
- Stackable screw-top organizer
- 100 sterling silver crimps
- Instruction book
- Chain, flat and round nose pliers
- Italian flush cutters
- Knotting tool with instructional video
- Pearl/bead tweezers
- Bees wax
- Silk thread assortment
- Jewelers' Cement

Stock #

KIT-421.00

\$99.95



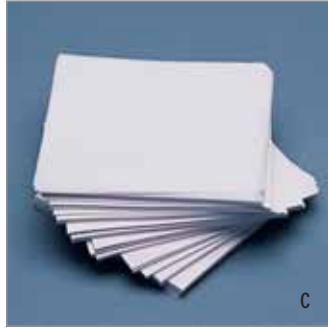
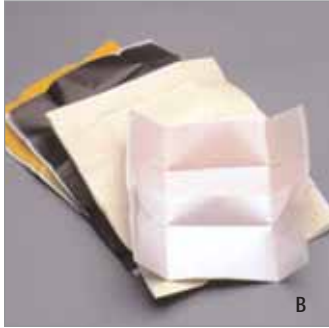

A. ANTWERP-STYLE DIAMOND PAPER

Our Antwerp-style diamond papers are the finest available, and are the best way possible to protect and show precious stones. Dimensions when folded are 3" x 15/8" which protects stones and keeps them in their proper order. We offer both watermarked and embossed (lined) in the following color combinations. Sold by box of 100, packaged by 25 sheets.

Stock #	Description	Qty.	
DIA-301.01	White/White, Watermarked	bx/100	\$11.53
DIA-301.02	Blue/White, Watermarked	bx/100	\$12.78
DIA-301.04	Blue/Blue, Watermarked	bx/100	\$14.43
DIA-301.05	Blue/White, Lined	bx/100	\$12.78

B. COLORED STONE PAPER

Colored stone paper is a new idea and excellent for all your colored stones. Show off loose colored stones with the proper paper. Enhances sales and shows that you are a true professional. They measure 27/8" x 15/8" folded and fit nicely into stone paper wallets. Sold in an assortment of 100 containing 25 pieces of each four colors or in individual packages of 25 each.

Stock #	Description	Color	Qty.	
DIA-303.06	Sapphire	White	pk/25	\$2.25
DIA-303.08	Ruby	Yellow	pk/25	\$2.25
DIA-303.09	Emeralds	Ivory	pk/25	\$2.25

ANTI-TARNISHING TISSUE SQUARES

Known in the industry as watch paper, these handy squares of tissue are excellent for wrapping small parts for shipping, storing or handling. Economical, each box contains 1000 sheets of 4" x 4" high quality tissue which keeps parts from rubbing and scratching.

Stock #	Size	Qty.	
C. DIA-305.00	4" x 4"	bx/1000	\$4.75

DIAMOND PAPERWEIGHT

Perfect for holding stone papers while sorting or packing. This folding diamond paperweight opens to 5 1/2" x 6" and folds to a compact 4 3/4" x 1 1/4".

Stock #		
D. DIA-133.00		\$4.25

LEATHER PARCEL BOX

Leather box is an ideal way to hold your stones. More eye-appealing for in-store use than a wallet. Great for storage in a safe, too. Inside measures 3 1/2" x 6 1/2".

Stock #		
E. DIA-130.00		\$16.95

DELUXE SECURITY DIAMOND WALLET

This handsome, multi-fold, supple black leather diamond wallet fits perfectly into pockets. It features a reinforced grommet for use with safety chains. Elastic bands insure security. Luxuriously lined with silk.

Stock #	Size	
F. DIA-134.00	4" x 7" x 1 1/2"	\$18.95

DIAMOND PAPER WALLETS

These leather wallets are made of the finest kidskin. Soft leather wallets are the perfect way to carry stones in stone papers. Velvet lined and features a zipper closure for maximum security.

Stock #	Size	
G. PKG-415.00	6" x 3 1/2" x 1 1/4"	\$13.95
H. PKG-416.00	6" x 3 1/2" x 3/4"	\$12.95

UNIVERSAL SWIVEL HANDLE with CHUCK

Excellent for drilling, reaming and various other applications because the barrel turns by twisting the knurled collar. Made in France with a chuck opening 0 to 3mm.

Stock #	Length	
A. HAN-734.00	4"	\$14.25



UNIVERSAL HANDLE/HOLDER

Versatile 3 1/8" chuck-style holder can be used with beading tools, millgrain tools, gravers and small needle files. Comfortable hardwood handle at an affordable price. The two chucks have a range of 0 to 3mm.

Stock #	Length	
B. HAN-736.00	3 1/8"	\$3.95



TOOL HOLDER

French-made chuck-style holder can be used with beading tools, millgrain tools, gravers and small needle files. The hardwood handle is shaped for hours of comfortable use. Comes with two chucks for a range of 0 to 3mm.

Stock #	Length	
C. HAN-735.00	3 1/4"	\$9.05



TOOL HANDLE

French-made tool handle with two chucks that range from 0 to 3mm. Most commonly used as an engraving handle, it is tempered steel and hardwood – the best quality available.

Stock #	Length	
D. HAN-733.00	2 3/4"	\$6.80

DELUXE HARDWOOD BEADER HANDLE

Our deluxe wood beader handle with brass fixture holds the beading tool snugly in place. However, this handle at 2 3/4" in length and 1 1/4" in diameter gives the user much better leverage and greater comfort than standard shorter beader handles. Made of hardwood and brass, this handle will save the user from fatigue and assure more control.

Stock #	Length	
E. HAN-650.00	2 3/4"	\$2.65



EXCLUSIVE



Deluxe wood beader handle with brass fixture holds the beading tool snugly in place.

BEADING TOOL PLATE

Our deluxe European plate features a brass body with 12 sunken steel bead inserts that are perfectly formed and polished. They are used for reshaping the ends of standard size beading tools.



Stock #	Size	
F. BDP-391.00	7/8"	\$35.95

EUROPEAN BEADING TOOLS and SETS

The world's hardest beading tools are superbly finished in the cone. Once you use these, you will never accept any other. Dimensions: diameter 2.6 x 60mm. Sets include hardwood handle and storage stand with see-thru lid.

Stock #	Description	
G. BDR-100.00	Set of 12 (Includes sizes: 2,4,6,7,8,9,10,11,12,13,14,16)	\$18.25
BDR-120.00	Set of 23 (Includes one of each size shown below)	\$26.75

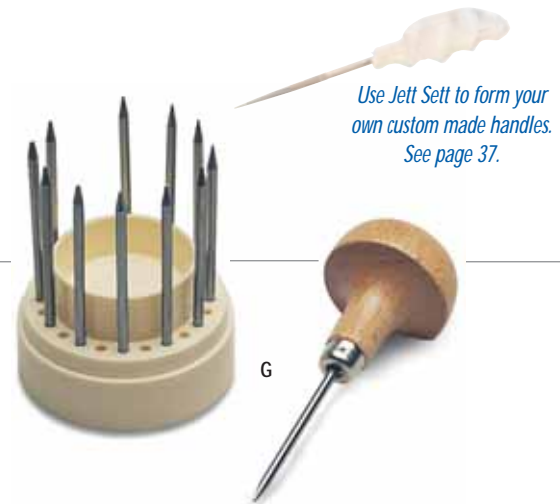

Use Jett Sett to form your own custom made handles. See page 37.

Individual Tips	Size	Individual Tips	Size	Individual Tips	Size
BDR-100.0A	#0	BDR-100.08	#8	BDR-100.16	#16
BDR-100.01	#1	BDR-100.09	#9	BDR-100.17	#17
BDR-100.02	#2	BDR-100.10	#10	BDR-100.18	#18
BDR-100.03	#3	BDR-100.11	#11	BDR-100.19	#19
BDR-100.04	#4	BDR-100.12	#12	BDR-100.20	#20
BDR-100.05	#5	BDR-100.13	#13	BDR-100.21	#21
BDR-100.06	#6	BDR-100.14	#14	BDR-100.22	#22
BDR-100.07	#7	BDR-100.15	#15		

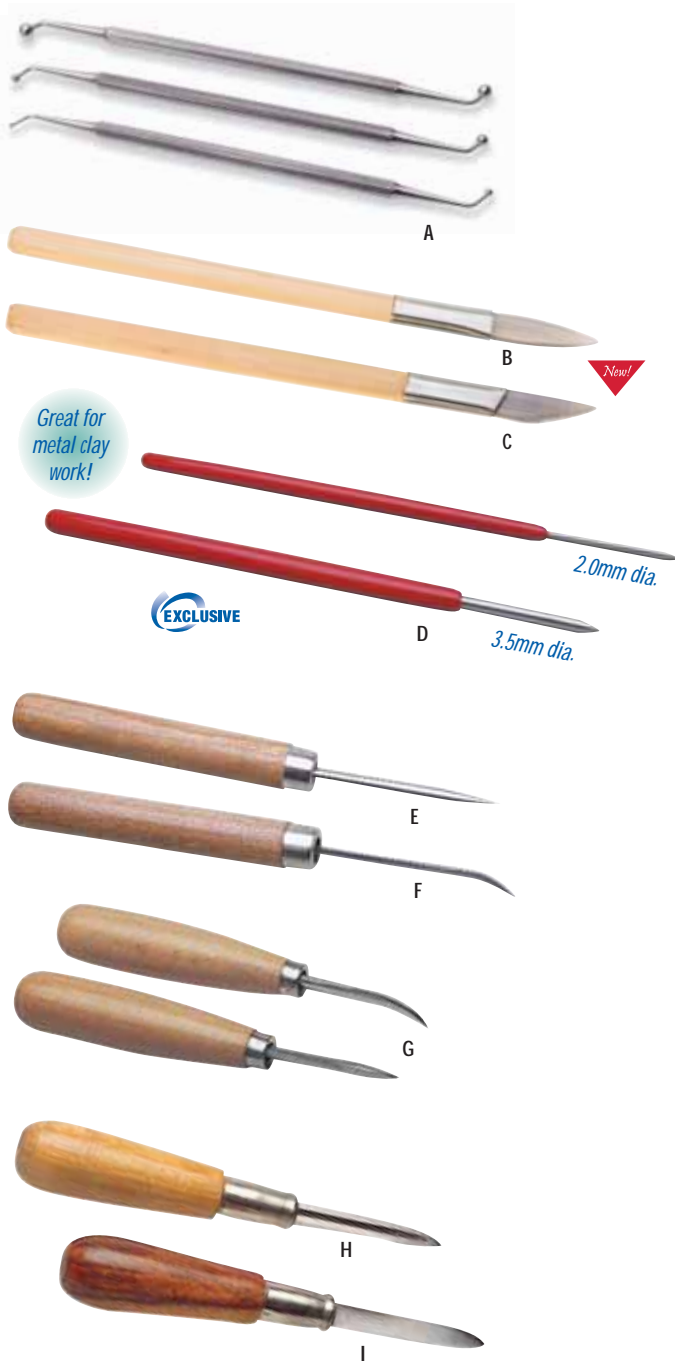

Great for
metal clay
work!

EXCLUSIVE

New!

2.0mm dia.

3.5mm dia.

DOUBLE ROUND HEAD BURNISHERS

Beautifully made of high grade stainless steel. Each perfectly round head is polished to a mirror finish. Used to form PMC, this set is excellent for wax and clay as well. Each is double-ended; six sizes in all with serrated handles, these burnishers are a must for every bench. Also available individually.

Stock #	Description	Length	
A. BRN-300.00	Set of Three		\$19.95
BRN-300.15	Small (1.5 and 2.0mm)	6½"	\$6.39
BRN-300.30	Medium (2.5 and 3.0mm)	6½"	\$6.39
BRN-300.50	Large (4.0 and 5.0mm)	6½"	\$6.39

AGATE BURNISHERS

Our natural agate stone burnishers are perfect for metal clay work, Keum-boo applications and applying gold and silver foil. Also works to burnish unfired metal clay. Can be used like a steel burnisher for smoothing metals and closing bezels, but unlike steel burnishers, they will not damage stones.

Stock #	Description	Length	
B. BRN-620.05	Agate Burnisher - Straight	8½"	\$13.35
C. BRN-620.06	Agate Burnisher - Knife	8½"	\$13.35

RED-HANDLED BURNISHERS

A EURO TOOL exclusive made of stainless steel with comfortable PVC grips. This style of burnisher is especially handy for smaller jobs, precious metal clay work and a variety of other tasks. With mirror polished tips, you'll get years of service.

Stock #	Description	Length	
D. BRN-150.00	Set of 2		\$9.65
BRN-150.20	2.0mm diameter	6¼"	\$4.85
BRN-150.30	3.5mm diameter	6¼"	\$4.85

SLIM BURNISHERS WITH WOOD HANDLES

Slim steel burnishers with hardwood handles are perfect for smaller jobs. Highly polished steel assures the user a smooth finish every time. Hardwood handle is the right grip for this well made burnisher. Some prefer straight, others bent – the choice is yours.

Stock #	Description	Length	
E. BRN-210.25	Straight	6"	\$4.95
F. BRN-215.25	Bent	6"	\$4.95

G. BURNISHERS

Highly polished tool steel burnishers with hardwood handles and metal ferrules for long life. Each burnisher is oval shaped for smoothing metals or bezel setting around stones. Features either curved or straight blades set in hardwood handles.

Stock #	Description		Stock #	Description	
BRN-100.10	Straight – 1"	\$2.95	BRN-200.10	Curved – 1"	\$2.95
BRN-100.15	Straight – 1½"	\$2.95	BRN-200.15	Curved – 1½"	\$2.95
BRN-100.20	Straight – 2"	\$2.95	BRN-200.20	Curved – 2"	\$2.95
BRN-100.25	Straight – 2½"	\$2.95	BRN-200.25	Curved – 2½"	\$2.95

SCRAPERS

Scrapers are used for smoothing, cleaning, and deburring plastics and metals. With their hardwood handles they prepare the surface for soldering, removing excess solder and opening bezels. Can be resharpened on a bench stone.

Stock #	Description	Total Length	Blade Length	
H. BRN-600.30	Hollow Scraper	7"	2½"	\$5.65
I. BRN-600.20	Solid Scraper	7"	2½"	\$5.65

TUNGSTEN-CARBIDE ROTARY BURNISHERS

Rotary burnishers are the quickest, easiest and surest way to remove porosity, firescale, pinholes, and scratches from gold, platinum and silver. The faceted sides of each polished tungsten-carbide burnisher gives a coarse, medium or fine finish depending on the number of facets. ⅜" shanks. Max. 10,000 RPM.

Stock #	Size	# Facets	Finish	
J. BRN-405.12	5 x 13mm	12	Coarse	\$31.50
K. BRN-405.18	5 x 13mm	18	Medium	\$31.50
L. BRN-405.36	5 x 13mm	36	Fine	\$31.50
M. BRN-410.12	10 x 7mm	12	Coarse	\$32.95
N. BRN-410.18	10 x 7mm	18	Medium	\$32.95
O. BRN-410.36	10 x 7mm	36	Fine	\$32.95

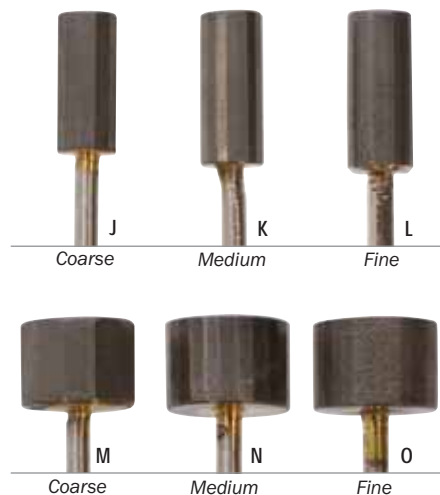

New!

Coarse

Medium

Fine

Coarse

Medium

Fine

DIAMOND-TIPPED SCRIBE

Diamond-tipped pocket scribe for use on hard metals. Features a lightweight, aluminum handle with chuck. Made in USA. 7" length.

Stock #		
A. SCB-431.00		\$8.25

CARBIDE SCRIBES

Pen sized knurled aluminum holder is 5/16" in diameter and 5 1/4" overall length with a 1/8" tungsten carbide tip firmly pressed into the end. Available with or without a magnet. Made in USA.

Stock #	Description	
B. SCB-535.00	Scribe	\$6.95
C. SCB-536.00	Scribe w/ Magnet	\$7.95

PREMIUM CARBIDE SCRIBE

Our 5 1/2" premium scribe is 3/8" in diameter with removable carbide tips and includes one regular and one fine tip both 1 1/4". Tips reverse in chuck when not in use. Extra tip stores in handle. Made in USA.

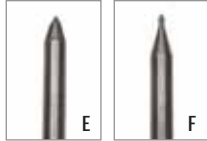

Stock #	Description	
D. SCB-537.00	Premium Scribe with Two Tips	\$13.95
E. SCB-537.05	Replacement Tip - Regular (pk/2)	\$4.95
F. SCB-537.10	Replacement Tip - Fine (pk/2)	\$6.05

CARBIDE SCRIBES

Our carbide scribes are always where you want them - in your pocket. Hardened carbide tip ensures extended life. The sharp point will give you a precise mark in virtually any material and the wood handle offers the user a comfortable grip. Tip is "double-shouldered" to a very fine point.

Stock #	Description	Length	
G. SCB-435.00	Steel Casing	4 3/4"	\$4.45
H. SCB-436.00	Wood Casing	5 1/4"	\$3.90

DELUXE TOOL STEEL SCRIBE

Designed to fit the hand perfectly to assure accuracy and fatigue-free use. Our scribe features an American-made hardwood handle and a tempered tool steel point which may be resharpened. Check out our price - you won't find a scribe of this quality anywhere near this price.

Stock #	Length	
I. SCB-530.00	4 3/4"	\$4.20

PRONG OPENER

Our prong opener/lifter is made of high-grade tool steel. Nicely polished and beveled on one end for smaller mountings, this industry standard is tempered to the proper hardness, tough but not brittle. The handle is a thick attractive dark blue PVC for comfort and stability.

Stock #	Length	
J. PSH-135.10	4 3/4"	\$14.55

ECONOMY PRONG OPENER

Made of tempered steel, this is our economical model. A great value for the price.

Stock #	Length	
K. PSH-129.00	4 3/4"	\$5.05

PRECISION PRONG OPENER

Only 4" (100mm) long and a narrow .079" (2.0mm) thick, this highly tempered opener allows the jeweler easy access to small prongs. Durable, yet precise, this is the best prong opener on the market. Made in USA.



Stock #	Length	
L. PSH-145.00	4" (100mm)	\$12.95

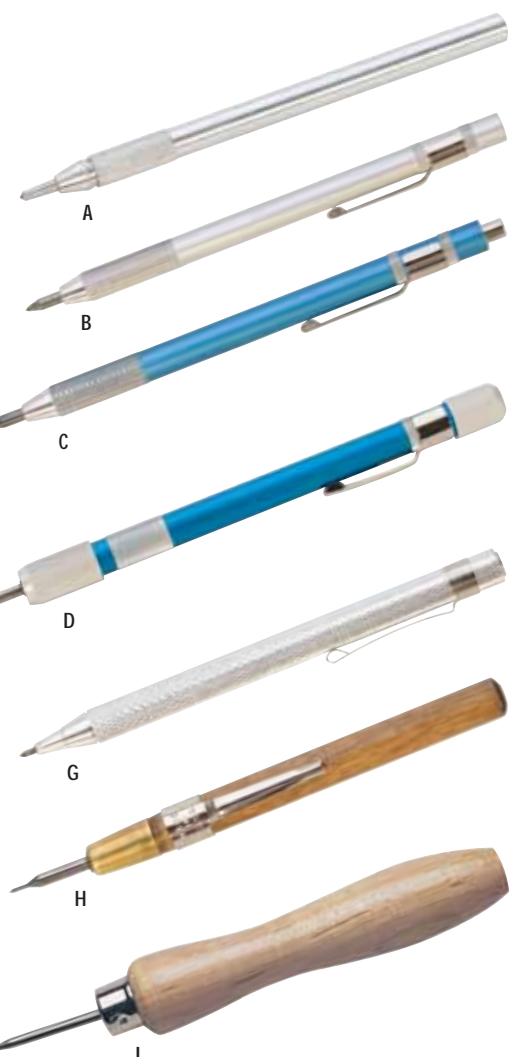

Replaceable Tips!



Quality steel dividers also used for scribing can be found on page 95.



Comfortable
wood handle.



A



B



C



EXCLUSIVE

D

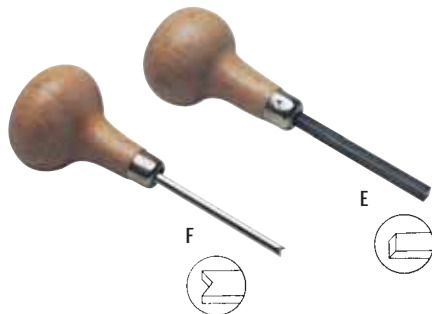

E



F



G



H

New!

BEZEL ROLLER

The half-round polished steel rocker rolls and pushes bezels around stones. It's recommended for larger settings and is mounted on a wooden handle.

Stock #	Length	
A. PSH-775.00	4 1/4"	\$2.95

"BEZEL PERFECT" ROLLER

This improved bezel roller is an upgraded version to assure a better job – faster and easier. With a wider blade (3mm) and re-designed handle, our Bezel Perfect is more ergonomic. The highly polished roller blade assures smoother, more uniform results than conventional bezel rollers, especially on wider bezels.

Stock #	Length	
B. PSH-776.00	4 3/4"	\$4.95

DIAMOND SETTERS HELPER

This tool makes channel setting and prong setting faster and easier. Just fit one of the two collars onto a standard 3/32" shank bur and be assured that each cut will be the same distance from the top of the edge on channels or prongs. Burs sold separately.

Stock #		
C. DIA-160.00		\$19.95



MARTINI HOLDERS

Made exclusively by EURO TOOL to hold three prong "Martini" mountings. Each die adapts to the accompanying pin vise. The pin vise holds the mounting in place so that the jeweler can close each prong with a pair of pliers. Fast and easy, three sizes: small, medium, large and set comes complete with pin vise.

Stock #	Description	
D. HOL-167.00	Set of 3 with Pin Vise	\$20.95
HOL-167.05	Martini Holder - Small	\$5.95
HOL-167.10	Martini Holder - Medium	\$5.95
HOL-167.15	Martini Holder - Large	\$5.95

PRONG PUSHER

This handy tool has a polished steel tip set in a comfortable wooden handle. It's used to bend prongs while setting stones. 4" length.

Stock #	Length	
E. PSH-770.00	4"	\$2.60

BEZEL PUSHER

The polished groove in the tip sets and pushes the bezel against the stone. Mounted securely in hardwood handle with reinforcing collet. 4 1/4" length.

Stock #	Length	
F. PSH-771.00	4 1/4"	\$2.95

FINAL TOUCH

Easy-to-use tool for tightening prong settings or setting stones on earring studs with just one tap. Stones will never be chipped or cracked because pressure is distributed simultaneously and equally among the four or six prongs. Includes urethane post earring base (holds up to 12 studs) and five tools (2.0-3.4mm, 2.8-5.2mm, 3.2-6.6mm, 4.9-8.6mm, 5.6-10.0mm).

Stock #		
G. DIA-163.00		\$56.00

SETTING BURNISHERS

Stone setting system with hardwood handle and 18 concave tempered punches is ideal for setting stones. Simply insert the stone and press the punch directly over the prongs to set. The concave shape pushes prongs in gently and evenly. This system is especially good for more fragile stones. Supplied in an attractive wood box, it will set stones from 2mm up to 6mm in diameter.

Stock #		
H. BRN-418.00		\$51.95

MILGRAIN TOOLS

Premium French-made millgrain tools are used for forming decorative edges on settings and bezels. Available individually in sizes 1-15. Set of six assorted sizes, ranging from 2-12 with premium chuck style handle.



Set of six includes premium chuck-style handle.

Stock #	Description	
A. MLG-200.00	Set of Six with Handle (size 2 - 12)	\$63.95
MLG-200.01	#1	\$10.95
MLG-200.02	#2	\$10.95
MLG-200.03	#3	\$10.95
MLG-200.04	#4	\$10.95
MLG-200.05	#5	\$10.95
MLG-200.06	#6	\$10.95
MLG-200.07	#7	\$10.95
MLG-200.08	#8	\$10.95
MLG-200.09	#9	\$10.95
MLG-200.10	#10	\$10.95
MLG-200.11	#11	\$10.95
MLG-200.12	#12	\$10.95
MLG-200.13	#13	\$10.95
MLG-200.14	#14	\$10.95
MLG-200.15	#15	\$10.95



DIAMOND SELLER - BRILLIANT CUTS

Handy aide for showing the size of brilliant cut diamonds. Ten separate sizes, shown with cubic zirconia and each one has the size and carat weight stamped on the arm. Sizes are 0.10 to 2 carats (3mm to 8.2mm). Folded length 4 1/4".

Stock #		
B. DIA-336.00		\$38.95



FANCY DIAMOND SELLER

Ideal tool for showing different shaped stones. Diamond Seller has seven shapes including: emerald, oval, pear, square, round, marquise and baguette. Folded length 4 1/4".

Stock #		
C. DIA-337.00		\$39.95



DIAMOND WASHING CUP

The perfect way to wash diamonds or other loose stones with alcohol. Features an inside perforated cup and metal lid to assure proper cleaning. Glass jar is 2 1/2" in diameter and 2 1/4" high (6.35mm x 57.2mm).

Stock #		
D. DIA-328.00		\$6.95



E. APPRAISAL CERTIFICATES and ENVELOPES

Very professional! Appraisal forms are three-part NCR paper that contain standard appraisal language. The professional-looking forms with official green ink can be typed, written, or run on computer as the forms are accordion folded and feature standard tear-away tractor feed holes.

Stock #	Description	Qty.	
APR-100.00	Appraisal Certificates	bx/100	\$30.00
APR-105.00	Appraisal Certificates	bx/50	\$16.95
APR-100.05	Envelopes for Certificates	bx/100	\$29.95
APR-105.05	Envelopes for Certificates	bx/50	\$13.95
APR-100.50	Appraisal Pack	50 Certificates / 50 Envelopes	\$28.95



F. SORTING PADS

Secured on all four corners, these sorting pads allow user to conveniently reference items being sorted. Each pad includes 12 thick sheets.

Stock #	Size	
DIA-320.00	5 1/2" x 7 1/2"	\$2.85
DIA-322.00	8" x 10"	\$5.20
DIA-324.00	10" x 12"	\$6.05

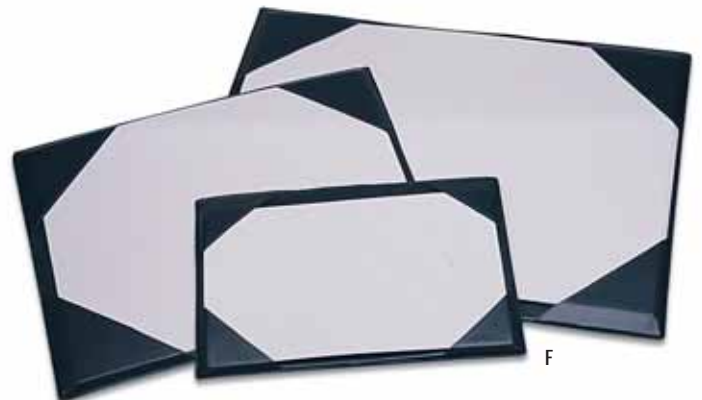



EXCLUSIVE



Jaws do not cover the girdle of stones like other gem holders. Jaws turn so that diamonds and other stones remain in the user's field of view when being rotated.

STONEPERFECT GEM HOLDER

Our new "StonePerfect" gem holder, is the only unit to meet all requirements of gemologists. The StonePerfect was designed and engineered by EURO TOOL in response to requests over the past several years. We believe that it is absolutely the best holder available, and it is priced far lower than many inferior models.

- Black jaws of non-glare glass-filled nylon have surface tack and serrations to hold all gemstones securely.
- Jaws do not cover the girdle of stones as other gem holders do.
- Jaws turn on-axis so that diamonds and other stones remain in the user's field of view when being rotated.
- StonePerfect Gem Holder includes an adapter so it can be fitted to any microscope, although it will fit 80% of all microscopes right out of the package.
- Comes in a sturdy plastic box for maximum protection.

Stock #

A. HOL-510.00

\$39.95



B



C



D



E

EASY LOOP GEM HOLDER



The right way to hold a stone so it can be seen is by the girdle. EURO TOOL has designed the Easy Loop Gem Holder to do just that. Conventional three and four prong holders can scratch delicate stones. EURO TOOL's exclusive Easy Loop gently holds stones the correct way. This assures the best view without any possibility of scratching. Large holder measures 4 1/2" (115mm). Small holder measures 2 1/4" in length.

Stock #	Description	Length	
B. HOL-663.00	Large Easy Loop Gem Holder	4 1/2"	\$4.95
C. HOL-664.00	Small Easy Loop Gem Holder	2 1/4"	\$4.95

STONE HOLDERS

Stone holders are spring-loaded with contracting wire jaws for examining gemstones or other small items. Available in mini (2 1/4") or pocket size (5").

Stock #	Description	Length	
D. HOL-653.00	3 prong jaws	5"	\$2.45
HOL-654.00	4 prong jaws	5"	\$2.45
E. HOL-660.00	3 prong jaws	2 1/4"	\$2.25
HOL-661.00	4 prong jaws	2 1/4"	\$2.25



Design ensures a secure hold and better visual sales aid.



F

F. SURE HOLD DISPLAY RINGS

Available in silver or gold tone for displaying diamonds and other precious stones. Four styles available: gold in regular or long prongs and silver in regular or long prongs. You will find our quality superior to all others and now with an improved design for a more secure hold and a better visual aid. This is the best possible way to present loose stones as a sales aid and it's much more secure for customers than tweezers. Attractive, functional and priced right!

Stock #	Description	
DIS-200.02	Gold, Regular Prongs	\$3.25
DIS-200.03	Silver, Regular Prongs	\$3.25
DIS-210.02	Gold, Long Prongs	\$3.25
DIS-210.03	Silver, Long Prongs	\$3.25

Use several Gem Display Stands together for an effective store display.



G

GEM DISPLAY STAND

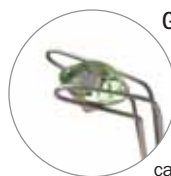

Suspend your beautiful gemstones for display so that they can be seen. This visually appealing display unit allows stones to "float." Metal base ensures stability. In addition, the salesperson can remove the display so that customers can see the stone up close without using a tweezer! Displays are effective sales tools and economical. Show precious gemstones at their best, suspended alone for maximum viewing.

Stock #

G. HOL-525.00

\$7.95

HIGH-SPEED STEEL EURO TWIST DRILLS

Quality made HSS twist drills made to exacting tolerances. Bright finished, with exactly the proper cutting angle at the tip. Flutes are sharp with the proper spiral and finished outer edges. The finest grade tool steel, tempered for maximum hardness and endurance. Individual drills packaged ten to a see-thru tube and labeled with the drill size for easy identification. Assortment includes one tube (10 pc) each sizes 61–80 and a hardwood stand marked with the appropriate size. Please add drill number as suffix when ordering individually.

Stock #	Description	Qty.	
A. DRL-226.xx	Sizes 50 – 71	pk/10	\$5.70/pk
DRL-226.xx	Sizes 72 – 74	pk/10	\$5.90/pk
DRL-226.xx	Sizes 75–80	pk/10	\$6.90/pk
B. DRL-200.00	Assortment w/ Wood Stand Sizes 61–80	200 pc	\$115.50/st



Lets you store, replenish and retrieve the size you need with ease!

Packaged 10 drills to a see-thru tube and labeled with drill size for easy identification.



3/32" UNIFORM SHANK TWIST DRILLS

Polished steel twist drills with uniform 3/32" shanks can be used with all quick-change or Jacobs chuck-style handpieces. Available in all popular sizes by .10mm increments, sold individually or in sets. Individual sizes are packed six per box, priced per piece. Swiss-made.

Stock #	Description	
DRL-250.00	24 Piece Set (two each of drill sizes 0.50mm-1.60mm)	\$49.75
C. DRL-250.02	12 Piece Set (one each of drill sizes 0.50mm-1.60mm)	\$25.65
DRL-250.50	0.50mm	\$2.40
DRL-250.60	0.60mm	\$2.40
DRL-250.70	0.70mm	\$2.40
DRL-250.80	0.80mm	\$2.40
DRL-250.90	0.90mm	\$2.40
DRL-251.00	1.00mm	\$2.40
DRL-251.10	1.10mm	\$2.40
DRL-251.20	1.20mm	\$2.40
DRL-251.30	1.30mm	\$2.40
DRL-251.40	1.40mm	\$2.40
DRL-251.50	1.50mm	\$2.40
DRL-251.60	1.60mm	\$2.40



3/32" Uniform Shank Swiss-made twist drills.



DORMER TWIST DRILLS

High-quality drills have straight shanks and are accurately ground then carefully tempered. They are available in a 20 piece set or individually in sizes No. 80 through No. 30 (.34mm to 3.26mm). Set includes sizes No. 61 to 80 and is packaged in a convenient case with slide cover that allows access to only the size you need, keeping all others securely in their place. For individual sizes order by using the stock number DRL-227 and the drill number (i.e. DRL-227.44 for drill No. 44). Packed ten per box.

Stock #	Description	Qty.	
D. DRL-227.00	Dormer 20 Piece Drill Set, sizes 61–80		\$28.80
DRL-227.xx	Sizes 30 – 50	pk/10	\$1.30/ea
DRL-227.xx	Sizes 51 – 68	pk/10	\$1.27/ea
DRL-227.xx	Sizes 69 – 70	pk/10	\$1.18/ea
DRL-227.xx	Sizes 71 – 77	pk/10	\$1.59/ea
DRL-227.xx	Sizes 78 – 80	pk/10	\$2.40/ea



HSS TWIST DRILLS

Tested and proven to be as good if not better than more well-known brands. Individual sizes available from No. 80 to 50. Packed ten to a box in traditional red packaging. Please add size number as suffix when ordering.

Stock #	Description	Qty.	
E. DRL-228.xx	Sizes 50 – 80	pk/10	\$0.71/ea



See chart below to order individually. Add drill # to the end of the stock number you wish to purchase (i.e. DRL-227.xx plus drill #67 becomes DRL-227.67).

Drill #	Inches	MM	Drill #	Inches	MM	Drill #	Inches	MM	Drill #	Inches	MM	Drill #	Inches	MM
30	.1285	3.264	41	.0960	2.438	52	.0635	1.613	63	.0370	0.940	74	.0225	0.572
31	.1200	3.048	42	.0935	2.378	53	.0595	1.512	64	.0360	0.914	75	.0210	0.533
32	.1160	2.946	43	.0890	2.261	54	.0550	1.397	65	.0350	0.889	76	.0200	0.508
33	.1130	2.870	44	.0860	2.184	55	.0520	1.321	66	.0330	0.838	77	.0180	0.457
34	.1110	2.819	45	.0820	2.083	56	.0465	1.181	67	.0320	0.813	78	.0160	0.406
35	.1100	2.794	46	.0810	2.057	57	.0430	1.092	68	.0310	0.787	79	.0145	0.369
36	.1065	2.705	47	.0785	1.994	58	.0420	1.067	69	.0292	0.734	80	.0135	0.343
37	.1040	2.642	48	.0760	1.930	59	.0410	1.041	70	.0280	0.712			
38	.1015	2.578	49	.0730	1.854	60	.0400	1.016	71	.0260	0.660			
39	.0995	2.528	50	.0700	1.778	61	.0390	0.990	72	.0250	0.635			
40	.0980	2.489	51	.0670	1.702	62	.0380	0.965	73	.0240	0.610			



A

HIGH-SPEED TWIST DRILL SET

If you need a variety of sizes, try our 20 piece high-speed steel twist drill set. One of each drill size No. 61 to 80 is included. The set is conveniently packaged in a plastic stand with clear domed lid. Sizes stamped on stand for easy selection and storage of proper drill size.

Stock #	Description	
A. DRL-230.00	20 Piece Set; Sizes 61-80	\$21.95

DRILL INDEX

Made of high-speed steel, this handy drill index offers sizes 61-80 (.0390"-.0135") for fine jobs. All drills are handily marked by size, finely ground and heat-treated to a Rockwell hardness of 63. Your small drill will stay conveniently organized in this handy metal index.

Stock #	Description	
B. DRL-240.00	20 Piece Set; Sizes 61-80	\$10.95

CUT LUBE

Hi-tech lubrication for most cutting applications. Use when sawing, drilling or drawing wire to insure cool, clean cuts. Cut Lube adheres to the tool surface and is less affected by heat than oil. Not only does Cut Lube make cutting easier and more precise, but it adds life to all of your cutting tools. The two ounce stick is made in the USA and comes in a convenient push-up plastic sleeve.

Stock #	Description	
C. BUR-180.00	2 oz.	\$3.95



C



D

SPIRAL HAND DRILL

Used for fine work, this European-made drill is spring-loaded with a steel chuck. Drill is 4 1/2" long and accepts No. 69 through No. 80 drills.

Stock #		
D. DRL-183.00		\$9.95

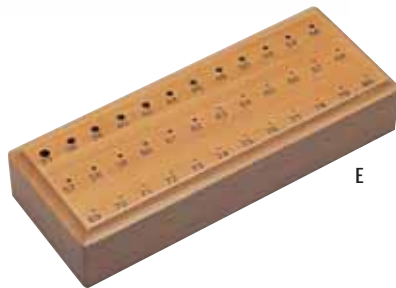

E

36 HOLE DRILL STAND

Marked with numbers for easy size identification of small twist drills sizes 33 through 80. Stand is 5" x 2" and makes drill access fast, accurate and easy.

Stock #		
E. DIS-936.00		\$9.99



F



Replacement drills conveniently store in handle. Available individually or in sets of 6 or 12.



POCKET DRILL SETS

Popular sized American made HSS drills in a blue anodized 3/8" diameter barrel with pocket clip, which prevents rolling. Drills store neatly into the handle which is well-knurled for a perfect grip. All machined parts are rust-free aluminum, except for the chuck, which is black oxide tool steel. The chuck is pressed into the barrel so that it cannot turn and opens easily - never binds. The chuck can take drill sizes from No. 80 (.0135") to 52 (.0635"). Individual drills available in tubes of six.

Stock #	Description	
F. DRL-245.06	6 pc Drill Set with Handle (sizes #52, 56, 60, 66, 70, 74)	\$11.95
DRL-245.12	12 pc Drill Set with Handle (all sizes listed below)	\$13.95
DRL-245.07	6 pc Replacement Drill Set in Tube	\$4.70
DRL-245.13	12 pc Replacement Drill Set in Tube	\$7.95

Individual Drills

Stock #	Drill #	Qty.	
DRL-245.52	#52	pk/6	\$4.95
DRL-245.54	#54	pk/6	\$4.95
DRL-245.56	#56	pk/6	\$4.95
DRL-245.60	#60	pk/6	\$4.95
DRL-245.62	#62	pk/6	\$4.95
DRL-245.64	#64	pk/6	\$4.95
DRL-245.66	#66	pk/6	\$4.95
DRL-245.68	#68	pk/6	\$4.95
DRL-245.70	#70	pk/6	\$4.95
DRL-245.72	#72	pk/6	\$4.95
DRL-245.74	#74	pk/6	\$4.95
DRL-245.76	#76	pk/6	\$4.95

DIAMOND-COATED TWIST DRILLS

We have added a medium-fine grit diamond coating to the tips of high-speed twist drills to drill stone, ceramic, glass and other hard non-metallic materials. The drills are made of superior high-grade steel. Available individually or in sets of twelve. Another EURO TOOL exclusive. *Drill size indicated below is before coating.*

Stock #	Description	Inches	MM	
DIB-227.36	#36 Diamond Drill	.1065	2.705	\$4.95
DIB-227.40	#40 Diamond Drill	.0982	2.489	\$4.95
DIB-227.45	#45 Diamond Drill	.0820	2.083	\$4.95
DIB-227.47	#47 Diamond Drill	.0785	1.994	\$4.95
DIB-227.50	#50 Diamond Drill	.0700	1.778	\$4.95
DIB-227.51	#51 Diamond Drill	.0670	1.702	\$4.95
DIB-227.52	#52 Diamond Drill	.0635	1.613	\$4.95
DIB-227.53	#53 Diamond Drill	.0595	1.512	\$4.95
DIB-227.54	#54 Diamond Drill	.0550	1.397	\$4.95
DIB-227.56	#56 Diamond Drill	.0456	1.181	\$4.95
DIB-227.61	#61 Diamond Drill	.0390	0.990	\$4.95
DIB-227.65	#65 Diamond Drill	.0350	0.889	\$4.95
A. DIB-227.00	Set of 12			\$46.95



DIAMOND CORE DRILLS

You can use core drills to cut holes in ceramic, tile and glass without chipping or cracking. Our diamond-coated core drills have a 3mm (1/8") shank, medium-fine grit and are made of stainless steel on which diamond particles have been electroplated. Six piece set packaged in reusable pouch.

Stock #	Description (mm size = diameter)	
DIB-501.50	1.50mm	\$5.42
DIB-502.00	2.00mm	\$5.42
DIB-502.50	2.50mm	\$5.42
DIB-503.00	3.00mm	\$5.42
DIB-504.00	4.00mm	\$7.84
DIB-505.00	5.00mm	\$8.47
DIB-506.50	6.50mm	\$10.82
DIB-509.50	9.50mm	\$14.86
DIB-510.00	10.00mm	\$15.90
DIB-511.00	11.00mm	\$18.27
B. DIB-500.00	Set of 6 (Sizes 1.5, 2.0, 2.5, 3.0, 5.0, 6.5mm)	\$38.95

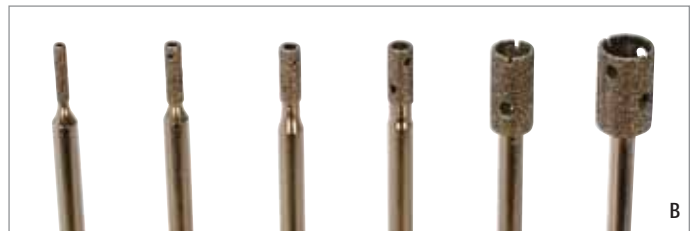

Always use a lubricant or water when working with diamond coated instruments.

DIAMOND "STICK" DRILLS

Perfect for drilling ceramic and stones, drills have diamond particles electroplated onto their hardened surface. Set of six includes sizes 0.75, 1.00, 1.25, 1.50, 2.00 and 2.50mm. Ideally used at speeds between 5,000 and 20,000 RPM, our drills provide the longest life of any in the industry. Also available individually.

Stock #	Description (mm size = diameter)	
DIB-550.75	0.75mm	\$2.75
DIB-551.00	1.00mm	\$2.75
DIB-551.25	1.25mm	\$2.75
DIB-551.50	1.50mm	\$2.75
DIB-552.00	2.00mm	\$2.75
DIB-552.50	2.50mm	\$2.75
C. DIB-550.00	Set of 6 (Sizes: 0.75, 1.00, 1.25, 1.50, 2.00, 2.50mm)	\$16.95



DIAMOND-COATED UNIFORM SHANK DRILLS

Our 3/32" shank Swiss-made twist drills with electroplated diamond particles are the ultimate for drilling stones, pearls, glass or ceramics. Use with standard hand-pieces and a small amount of water as lubricant. All drills are medium-fine grit.

Stock #	Description	
DIB-210.70	1.00mm	\$4.80
DIB-210.90	1.30mm	\$4.80
DIB-211.00	1.40mm	\$4.80
DIB-211.20	1.60mm	\$4.80
DIB-211.40	1.80mm	\$4.80
DIB-211.60	2.10mm	\$4.80
D. DIB-210.00	Set of 6	\$26.60

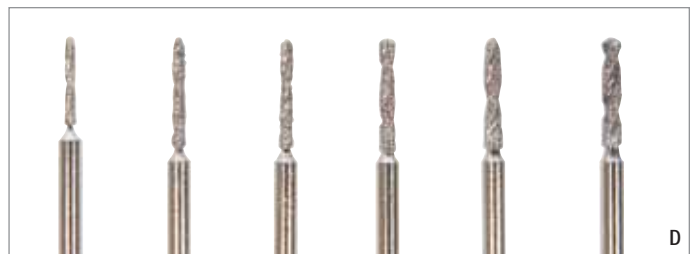

** Please note drill diameters are approximate due to the nature of the coating.*

RELENTLESS® NEEDLE FILES

EURO TOOL Relentless® needle files are made in Europe but very affordable. Made of the finest quality high carbon steel to exacting specifications, we believe our files will outperform anything in their price range and beyond. All are double-cut, with knurled handles and Swiss pattern design. We offer cuts 0, 2 and 4 in 6¼" (16cm) and 7¾" (20cm). We stock the six most popular shapes available individually or in sets.

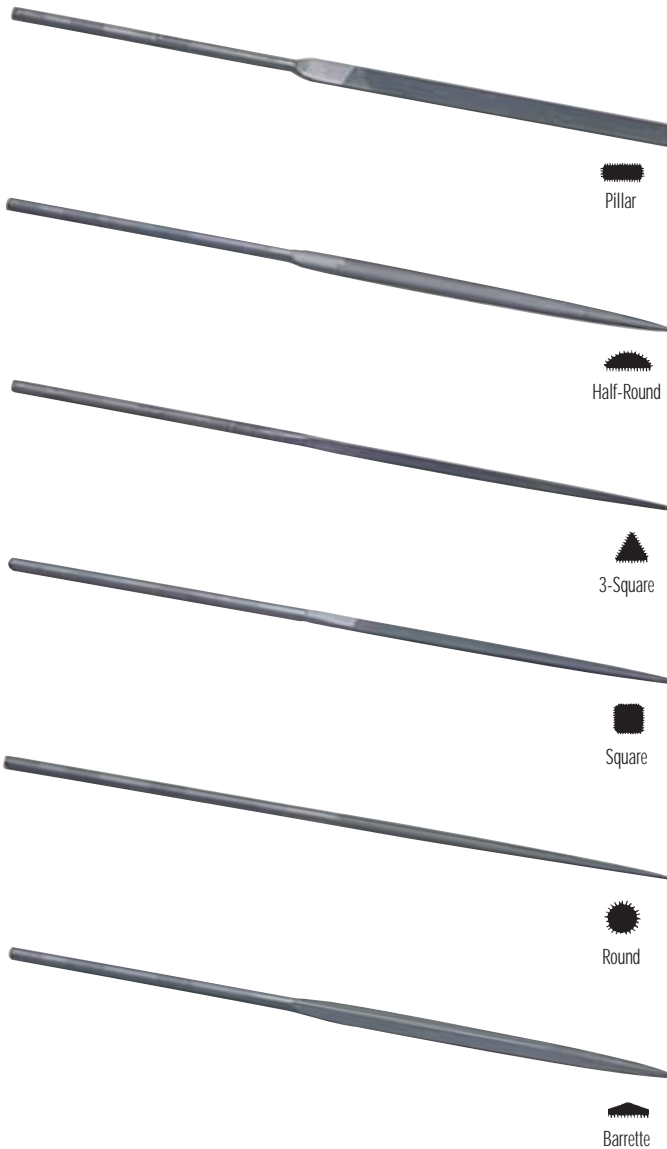
**PILLAR FILES**

Stock #	Description	Length	
FIL-202.10	Pillar, Cut 0	6¼" (16cm)	\$4.60
FIL-202.20	Pillar, Cut 2	6¼" (16cm)	\$4.60
FIL-202.30	Pillar, Cut 4	6¼" (16cm)	\$4.60
FIL-304.10	Pillar, Cut 0	7¾" (20cm)	\$5.75
FIL-304.20	Pillar, Cut 2	7¾" (20cm)	\$5.75
FIL-304.30	Pillar, Cut 4	7¾" (20cm)	\$5.75

HALF-ROUND FILES

Stock #	Description	Length	
FIL-207.10	Half-Round, Cut 0	6¼" (16cm)	\$4.60
FIL-207.20	Half-Round, Cut 2	6¼" (16cm)	\$4.60
FIL-207.30	Half-Round, Cut 4	6¼" (16cm)	\$4.60
FIL-309.10	Half-Round, Cut 0	7¾" (20cm)	\$5.75
FIL-309.20	Half-Round, Cut 2	7¾" (20cm)	\$5.75
FIL-309.30	Half-Round, Cut 4	7¾" (20cm)	\$5.75

THREE-SQUARE FILES

Stock #	Description	Length	
FIL-229.10	Three-Square, Cut 0	6¼" (16cm)	\$4.60
FIL-229.20	Three-Square, Cut 2	6¼" (16cm)	\$4.60
FIL-229.30	Three-Square, Cut 4	6¼" (16cm)	\$4.60
FIL-329.10	Three-Square, Cut 0	7¾" (20cm)	\$5.75
FIL-329.20	Three-Square, Cut 2	7¾" (20cm)	\$5.75
FIL-329.30	Three-Square, Cut 4	7¾" (20cm)	\$5.75

SQUARE FILES

Stock #	Description	Length	
FIL-232.10	Square, Cut 0	6¼" (16cm)	\$4.60
FIL-232.20	Square, Cut 2	6¼" (16cm)	\$4.60
FIL-232.30	Square, Cut 4	6¼" (16cm)	\$4.60
FIL-334.10	Square, Cut 0	7¾" (20cm)	\$5.75
FIL-334.20	Square, Cut 2	7¾" (20cm)	\$5.75
FIL-334.30	Square, Cut 4	7¾" (20cm)	\$5.75

ROUND FILES

Stock #	Description	Length	
FIL-242.10	Round, Cut 0	6¼" (16cm)	\$4.60
FIL-242.20	Round, Cut 2	6¼" (16cm)	\$4.60
FIL-242.30	Round, Cut 4	6¼" (16cm)	\$4.60
FIL-344.10	Round, Cut 0	7¾" (20cm)	\$5.75
FIL-344.20	Round, Cut 2	7¾" (20cm)	\$5.75
FIL-344.30	Round, Cut 4	7¾" (20cm)	\$5.75

BARRETTE FILES

Stock #	Description	Length	
FIL-249.10	Barrette, Cut 0	6¼" (16cm)	\$4.60
FIL-249.20	Barrette, Cut 2	6¼" (16cm)	\$4.60
FIL-249.30	Barrette, Cut 4	6¼" (16cm)	\$4.60
FIL-348.10	Barrette, Cut 0	7¾" (20cm)	\$5.75
FIL-348.20	Barrette, Cut 2	7¾" (20cm)	\$5.75
FIL-348.30	Barrette, Cut 4	7¾" (20cm)	\$5.75

SIX PIECE RELENTLESS® NEEDLE FILE SETS

Set of six Relentless® needle files in 6¼" (16cm) or 7¾" (20cm) sets. The following files are included: pillar, half-round, three-square, square, round and barrette.

Stock #	Cut	Length	
FIL-911.10	Cut 0	6¼" (16cm)	\$25.15
FIL-911.20	Cut 2	6¼" (16cm)	\$25.15
FIL-911.30	Cut 4	6¼" (16cm)	\$25.15
FIL-912.10	Cut 0	7¾" (20cm)	\$32.95
FIL-912.20	Cut 2	7¾" (20cm)	\$32.95
FIL-912.30	Cut 4	7¾" (20cm)	\$32.95

Handy needle file pouch made of durable canvas for portable storage. See page 87.

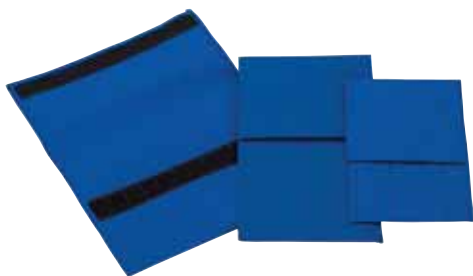

GROBET® HAND FILES

We offer precision Grobet® Swiss files, simply the finest file on the planet. Made of the best steel on modern equipment, each file is subject to inspection. The best quality available. Measurement of precision files indicates the length of cut. All files are standard 6" long.

Stock #	Description	Cut	Length	
A. FIL-000.10	Barrette	0	6"	\$22.50
FIL-000.20	Barrette	2	6"	\$25.25
FIL-000.30	Barrette	4	6"	\$28.35
B. FIL-040.10	Flat Hand	0	6"	\$16.65
FIL-040.20	Flat Hand	2	6"	\$17.95
FIL-040.30	Flat Hand	4	6"	\$20.85
C. FIL-020.10	Half-Round	0	6"	\$29.95
FIL-020.20	Half-Round	2	6"	\$32.35
FIL-020.30	Half-Round	4	6"	\$37.75
D. FIL-030.10	Half-Round Ring	0	6"	\$31.65
FIL-030.20	Half-Round Ring	2	6"	\$34.15
FIL-030.30	Half-Round Ring	4	6"	\$39.90

PRECISION HAND FILES

Our Swiss-pattern European files are made from the world's finest cutting steel, milled to the exact shape and size desired. All are the essence of durability and hardness combined with the feel that a fine file should have. Available individually or in four piece sets (includes one each: barrette, flat, half-round and half-round ring). Measurement of precision files indicates the length of cut.

Stock #	Description	Cut	Length	
A. FIL-100.10	Barrette	0	6"	\$16.50
FIL-100.20	Barrette	2	6"	\$17.95
FIL-100.30	Barrette	4	6"	\$21.75
B. FIL-110.10	Flat Hand	0	6"	\$9.50
FIL-110.20	Flat Hand	2	6"	\$10.35
FIL-110.30	Flat Hand	4	6"	\$12.95
C. FIL-120.10	Half-Round	0	6"	\$17.50
FIL-120.20	Half-Round	2	6"	\$18.25
FIL-120.30	Half-Round	4	6"	\$22.20
D. FIL-125.10	Half-Round Ring	0	6"	\$17.50
FIL-125.20	Half-Round Ring	2	6"	\$18.25
FIL-125.30	Half-Round Ring	4	6"	\$22.20
E. FIL-950.10	Set of Four in Pouch	0	6"	\$68.75
FIL-950.20	Set of Four in Pouch	2	6"	\$69.90
FIL-950.30	Set of Four in Pouch	4	6"	\$75.95

UNIVERSITY GRADE HAND FILES

Excellent student files in the required starter shapes. Also great files for any application where price is an issue. Starter set includes one 6" half-round and one 6" flat file in medium cut, plus a blue plastic handle which fits either file. Also sold separately.

Stock #	Description	
F. FIL-500.30	Set of Two Files with Handle (Flat, Half-Round)	\$14.65
FIL-511.30	Flat (Machinist Medium Cut)	\$5.95
FIL-521.30	Half-Round (Machinist Medium Cut)	\$5.95
HAN-720.00	File Handle	\$3.45

ROTARY FILES

Made of carbide steel to assure extra long life, these tools are used for deburring, smoothing and finishing the insides of rings. Also available an extra fine cut inside ring bur in high speed steel.

Stock #	Head Dia.	Head Length	Cut	Grit	
G. BUR-970.00	1/4"	1/2"	3/32"	Fine	\$12.75
H. BUR-972.00	1/4"	1/2"	3/32"	Coarse	\$12.75
I. BUR-974.00	3/8"	3/4"	1/8"	Fine	\$21.65
J. BUR-976.00	3/8"	3/4"	1/8"	Coarse	\$21.65

ROTARY FILES – Extra Fine

Stock #	Head Dia.	Shank	Cut	
K. BUR-978.19	4.70mm	3/32"	Extra Fine	\$5.30
L. BUR-978.26	6.30mm	3/32"	Extra Fine	\$6.10
M. BUR-978.30	8.00mm	3/32"	Extra Fine	\$6.50
N. BUR-978.34	11.10mm	3/32"	Extra Fine	\$8.50

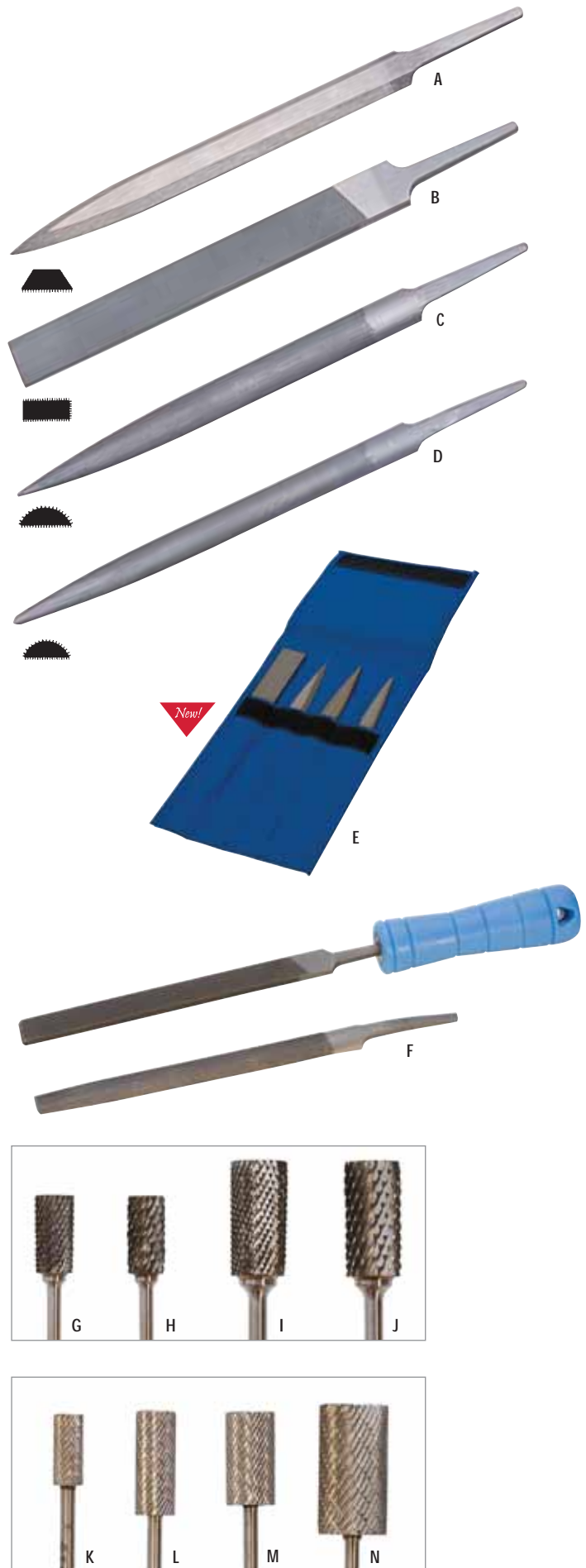

EXCLUSIVE



NEEDLE FILE HANDLES – THE WORLD'S BEST!

Blue anodized aluminum handles are well-knurled for an excellent grip. Length of handles is 4 1/2" and feature a steel "easy release" chuck which is pressed into the barrel to remain secure. Available in small, medium and large handle sizes each suitable for different file lengths. Handles will last a lifetime and make filing much easier. A EURO TOOL exclusive. Made in USA.

Stock #	Description	File Length	Handle Dia.	
A. HAN-739.00	Small Handle	4"	3/8"	\$7.75
B. HAN-740.00	Medium Handle	5 1/2" and 6 1/4"	1/2"	\$7.75
HAN-742.00	Large Handle	7 3/4"	1/2"	\$7.95
C. HAN-740.05	Medium w/ Textured Grip	5 1/2" and 6 1/4"	1/2"	\$8.25
HAN-742.05	Large w/ Textured Grip	7 3/4"	1/2"	\$8.25

WOOD FILE HANDLES

American-made file handles of hardwood with strong metal collars. Can be used with all tang files.

Stock #	Description	
D. HAN-175.00	#4 Twist-On Handle for 6" Files	\$2.45
HAN-185.00	#4 Press-On Handle for 6" Files	\$1.30

PLASTIC FILE HANDLE

Heavy duty for hand files securely holds as you work. Textured for secure grip. An excellent value. Length 4".

Stock #	
E. HAN-720.00	\$3.45

NEEDLE FILE HANDLE

Our universal needle file handle is made of durable plastic and shaped for comfortable use without fatigue. You can change files in seconds with a twist of the ring. It is 3 1/8" long and holds files securely for precision work. European made.

Stock #	
F. HAN-725.00	\$4.95

NEEDLE FILE HANDLE with BRASS CHUCK

Needle file handle with brass chuck offers the jeweler a reusable handle with a quality chuck which will not allow the file to slip or turn. Because the handle is a premium hardwood, it has excellent feel and grip for precision work. This handle fits 5 1/2" (140mm) needle files making it ideal to use with our economy needle files (page 85).

Stock #	
G. HAN-942.00	\$3.65

ROSEWOOD GRAVER HANDLES

Handles available in a variety of shapes with reinforcing metal collets.

Stock #	Description	Size	
H. HAN-601.00	Half-Head	1 1/2" x 1 1/4"	\$2.50
I. HAN-602.00	Half-Head, Long	2" x 1 1/4"	\$2.50
J. HAN-603.00	Round	1 5/8" x 1 3/8"	\$2.50
K. HAN-604.00	Mushroom	2" x 1 1/4"	\$2.50

SPECIAL GRAVER HANDLE

Our graver handle offers the best in comfort and convenience for those who do hand engraving. Made of ultra-hard boxwood, this graver handle features a groove which allows the user to adjust the length of the graver with relationship to the handle as the graver is sharpened (graver not included).

Stock #	
L. HAN-605.00	\$5.95

EXCLUSIVE

A. ECONOMY NEEDLE FILE SETS

Exceptional quality for outstanding value! Available in cuts 0 (fine) and 2 (coarse), in 5 1/2" (140mm) length. Handy three-piece, six piece or twelve piece sets. Count on our files for the highest and most consistent quality of files in this price range. Order them individually or in sets.

Stock #	Description	
FIL-992.50	Cut 2, 3 pc Set <i>(Includes Round, Three-Square, Half Round)</i>	\$4.15
FIL-993.00	Cut 2, 6 pc Set <i>(Includes: Square, Round, Half Round, Three-Square, Equaling, Barrette)</i>	\$6.85
FIL-994.00	Cut 0, 6 pc Set <i>(Includes: Square, Round, Half Round, Three-Square, Equaling, Barrette)</i>	\$6.85
FIL-995.00	Cut 2, 12 pc Set	\$12.60
FIL-996.00	Cut 0, 12 pc Set	\$12.60
Individual Needle Files (listed below)		\$1.10

Stock #	Shape	Cut		Stock #	Shape	Cut	
FIL-995.21	Round	2 Fine	\$1.10	FIL-996.21	Round	0 Coarse	\$1.10
FIL-995.22	Square	2 Fine	\$1.10	FIL-996.22	Square	0 Coarse	\$1.10
FIL-995.23	Knife	2 Fine	\$1.10	FIL-996.23	Knife	0 Coarse	\$1.10
FIL-995.24	Half-Round	2 Fine	\$1.10	FIL-996.24	Half-Round	0 Coarse	\$1.10
FIL-995.25	Oval	2 Fine	\$1.10	FIL-996.25	Oval	0 Coarse	\$1.10
FIL-995.26	Three-Square	2 Fine	\$1.10	FIL-996.26	Three-Square	0 Coarse	\$1.10
FIL-995.27	Warding	2 Fine	\$1.10	FIL-996.27	Warding	0 Coarse	\$1.10
FIL-995.28	Equaling	2 Fine	\$1.10	FIL-996.28	Equaling	0 Coarse	\$1.10
FIL-995.29	Barrette	2 Fine	\$1.10	FIL-996.29	Barrette	0 Coarse	\$1.10
FIL-995.30	Crossing	2 Fine	\$1.10	FIL-996.30	Crossing	0 Coarse	\$1.10



Use file handle HAN-740.00 (page 84) with 5 1/2" needle files.

MINI 4" NEEDLE FILE SET

Set of 12 extra-fine needle files allows you to get into tight spots. All are 4" (100mm) long and cut 2. This is the smallest set available and a must for fine work. Use file handle HAN-739.00 (page 66) with this set.

Stock #		
B. FIL-990.00		\$11.45

SIX PIECE POCKET FILE SET

This file set includes six different shapes all cut 2, 5 1/2" files with handles shortened so they conveniently store in the handle. With a handy, non-roll pocket clip and aluminum anodized handle, you can carry these sets anywhere.

Stock #	Description	
C. FIL-663.00	Set of 6 w/ Handle	\$17.55

POCKET MINI FILE SETS

Our 4" (100mm) mini files, all cut 2, store in the anodized handle. Features pocket clip and steel chuck. Handle is well-knurled for easy gripping.

Stock #	Description	
D. FIL-653.00	Set of 6 w/ Handle	\$10.95
FIL-655.00	Set of 12 w/ Handle	\$12.45

FIVE PIECE MINI FILE SET ON RING

Handy – we think so! This is a first – 4" needle files on a key ring. Okay...so you're not going to carry your key around with files in your pocket, but keeping them together makes a lot of sense. Various shapes and cuts for use with jewelry, PMC and much more.

Stock #		
E. FIL-900.05		\$7.95

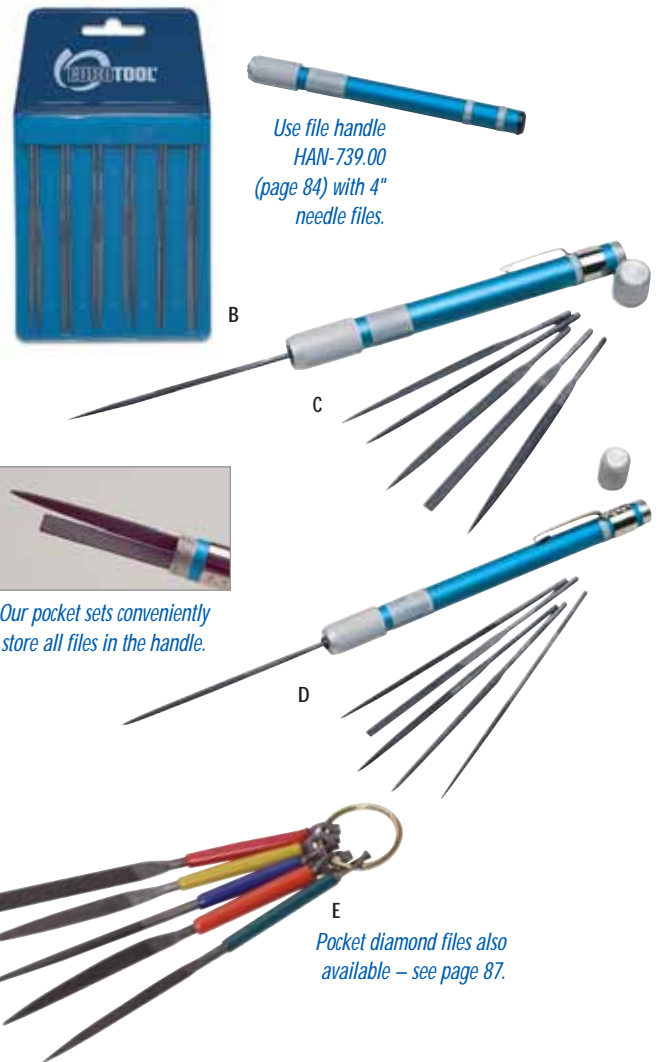

Use file handle HAN-739.00 (page 84) with 4" needle files.

Our pocket sets conveniently store all files in the handle.

Pocket diamond files also available – see page 87.



DELUXE EUROPEAN WAX NEEDLE FILES

Our customers say that this is the world's best wax needle file set. The teeth are finer and there are more teeth per inch than others. The points are fine, not blunt, which makes your work easier. All are 5 1/2" long. Sold as a set or individually.

Stock #	Description	
FIL-905.00	Set of 6	\$42.95

Individual Files

Stock #	Description	
A. FIL-700.00	Pillar	\$7.65
B. FIL-705.00	Three-Square	\$7.65
C. FIL-710.00	Half-Round	\$7.65
D. FIL-715.00	Square	\$7.65
E. FIL-720.00	Round	\$7.65
F. FIL-725.00	Warding	\$7.65

DOUBLE-ENDED WAX FILES

We offer double-ended vulcanite wax files in a wide range of values. With one end medium cut and the other end coarse, they can be used on plastic, wax or wood. All will last for years and we guarantee your satisfaction!

Stock #	Description	
G. FIL-998.00	8" Economy Model	\$10.85
H. FIL-999.00	8" Standard Model	\$18.95

DOUBLE-ENDED RIFFLER FILE SET

Our riffler files are 6" long, double-ended and offer quality at an exceptional price. We guarantee your satisfaction. The set of ten comes in a vinyl pouch for your convenience.

Stock #	Description	
I. FIL-991.00	Set of 10	\$15.35

RIFFLER SET with HANDLE

This ten piece riffler set is a new idea to enhance comfort and dependability when using rifflers. Our rifflers are single-ended and fit into the specially made aluminum handle. Each handle features a quick release steel chuck. Handles are made of anodized aluminum and are well-knurled for comfort and a sure grip. This is a EURO TOOL exclusive.

Stock #	Description	
J. FIL-991.50	Set of 10 with Handle	\$18.35

KEY FILE SET

Handy files known as "key files" feature six shapes with wood handles. The length of cut is 4", the double cut is approximately a cut 0 and overall length is 6 3/4". Excellent for wax, wood and various jobs. Shapes are flat, round, three-square, warding, square and half-round. Made in Germany. Handle length 2".

Stock #	Description	
K. FIL-986.10	Set of 6	\$11.95

FILE CLEANER

File cleaner removes small particles that clog teeth and reduce the file's ability to cut. A tool box necessity, steel wire bristles are set in a hardwood handle. Made in the USA. Length 8 1/4".

Stock #		
L. FCL-751.00		\$6.45



L

POCKET DIAMOND NEEDLE FILE SETS

Pen sized aluminum holder/handle with 3/8" diameter anodized barrel and pocket clip holds 5 1/2" diamond needle files with shortened shanks that are stored in the barrel. Handle has non-slip finger grip surface for positive control. An easy, convenient way to keep these files at your finger tips.

Stock #	Description	
A. FIL-671.00	Set of 3 (Includes: Flat, Three-Square, Half-Round)	\$16.95
FIL-673.00	Set of 5 (Includes: Flat, Three-Square, Half-Round, Square, Round)	\$19.95







DIAMOND-COATED NEEDLE FILES

The finest steel, milled to perfection with a diamond coating, makes this range of 5 1/2" files the best for precision filing jobs. Longevity is assured, as the diamond particles are electroplated onto the surface of the metal. Sold as a set or individually.

Stock #	Description	
B. FIL-965.00	Set of 5	\$45.60

Individual Files

Stock #	Description	
FIL-600.20	Pillar 	\$8.95
FIL-605.20	Three-Square 	\$8.95
FIL-610.20	Half-Round 	\$8.95
FIL-615.20	Square 	\$8.95
FIL-620.20	Round 	\$8.95



4" PRECISION DIAMOND NEEDLE FILE SET

Economy diamond needle file set of ten pieces. All are 4" (100mm) long with fine grit diamond electroplated onto high-grade stainless steel. Set includes: round, half-round, flat, three-square, square, warding, slitting, oval, knife, and barrette.

Stock #	Description	
C. FIL-974.00	Set of 10	\$12.95



DIAMOND NEEDLE FILE SETS

Economy diamond needle file sets of five or ten pieces. All are 5 1/2" (140mm) long with medium grit diamond particles electroplated onto high-grade steel.

Stock #	Description	
FIL-970.00	Set of 5 (Includes: Round, Half-Round, Flat, Three-Square, Square)	\$11.50
D. FIL-972.00	Set of 10 (Includes: Round, Half-Round, Flat, Three-Square, Square, Warding, Slitting, Oval, Knife, Barrette)	\$24.15



FILE POUCHES

Finally a pouch made to hold files. This sturdy vinyl backed canvas is made to take punishment so your files do not have to. The Velcro flap secures and protects the files which are contained in individual compartments. Available in 3 sizes, two for needle and one for hand files.

Stock #	Description	
E. PKG-460.06	6pc Needle File Pouch	\$4.95
F. PKG-460.12	12pc Needle File Pouch	\$5.95
G. PKG-460.04	4pc Hand File Pouch	\$5.95

FILE ORGANIZER

Made of hardwood, this tray keeps files organized and handy. Well-managed files will stay sharper longer. Tray is slanted for easy viewing.

Stock #	Size	Compartments	
PKG-106.00	9" x 12" x 1 1/2"	6	\$16.45
H. PKG-106.50	9" x 7" x 1 1/2"	5	\$15.25

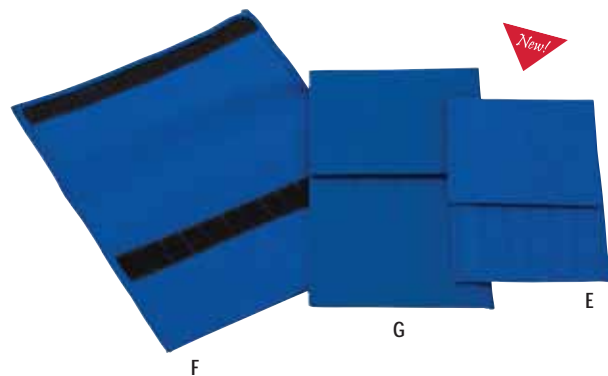

New!



A

**POCKET WIRE GAUGE** 

The Pocket Wire Gauge is all new and exclusively from EURO TOOL. Measures wire or sheet metal from gauges 34 to 8. Each size is also shown in fractions of millimeters and inches. This is the perfect gauge for beaders, wire wrappers and jewelers to easily identify wire or sheet metal gauge. Measures 3⁵/₁₆" x 1" and comes in a protective leather sheath. Great for pocket, purse or kit.

Stock #

A. GAU-144.10

\$13.95



C



B

MILLIMETER GAUGE

This handy gauge, known as a "pearl gauge" is excellent for stones of all kinds and comes in a leatherette pouch. Its smooth action assures accuracy. This gauge is made to zero out when closed and open automatically. This assures a gentle force by the user when measuring soft stones or pearls. The dial features "zero adjust" and is accurate to 0.1mm. Two models available with maximum opening of 10mm or 20mm. This gauge is compact and fits neatly into pocket or purse. GAU-146.10 also features a locking screw to hold measurement.

Stock #

Description

B. GAU-146.10	10mm Maximum Opening w/Locking Screw	\$29.95
GAU-146.20	20mm Maximum Opening	\$29.95

FAN GAUGE

A more versatile pocket gauge for measuring stones. This stainless steel gauge will measure brilliant cut, marquis, pear, square, emerald and oval cut stones. Nothing like it exists today and you'll be amazed at the quality. Measures 3¹/₂" closed. Measurements are carat weight.

Stock #

Description

C. GAU-140.00	7 Blade Fan Gauge	\$15.95
---------------	-------------------	---------

Folds to a compact 1¹/₂" to neatly fit into your pocket.



D

BAKER DIAMOND GAUGE

A versatile mounting and stone gauge, it has holes for measuring stones, and extensions for gauging mountings. Marked with carat sizes on one side and millimeters on the other.

Stock #

D. GAU-143.00		\$5.95
---------------	--	--------

DIAMOND POCKET GAUGE

Indispensable gauge helps to size gemstones quickly and accurately. Sizes range from 1 pt. to 2.1 ct., plus baguettes. Aluminum disks fold together when not in use.

Stock #

E. GAU-145.00		\$5.85
---------------	--	--------



E

Birthstone chart on the reverse side for a handy reference.



F

DIAMOND STONE GAUGE

Handy aluminum stone gauge measures stones and settings from .03 to 4 carats with red numerals for easy identification. Pocket size of 3⁵/₈" x 2³/₄" with birthstone chart on the back.

Stock #

F. GAU-141.00		\$6.95
---------------	--	--------

GEM ESTIMATOR GAUGE

The diamond weight estimator is perfect for determining the size of loose or mounted stones when other methods are unavailable. This estimator works for emerald, marquis, pear, round and baguette stones, as well as brilliant full cuts. Simply lay the gem estimator on your stone pad and place the diamond in question on the appropriate outline, and you will be able to instantly tell the approximate weight of your stone.

Stock #

G. GAU-131.00		\$4.70
---------------	--	--------

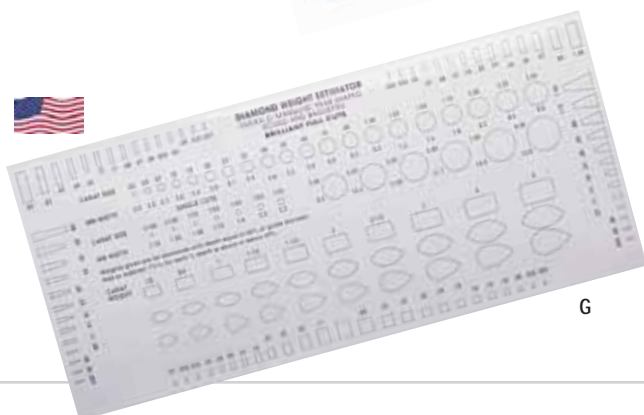

G

NYLON DIAL CALIPER (MILLIMETERS)

Made of tough plastic with a large metric "adjust-to-zero" dial for ease of reading and accuracy. This caliper features a thumb-roller with lock and a range of measurement from 0 to 150mm by 0.1mm increments. It measures outside, inside and hole depth and comes in a hard plastic case. Made in Switzerland.

Stock #	Length	Maximum Opening	
A. GAU-166.00	8 ⁷ / ₈ "	6" (150mm)	\$36.95

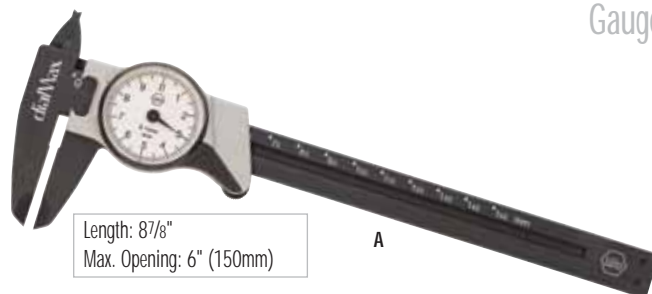
**NYLON DIAL CALIPER (INCHES and MILLIMETERS)**

Easy-to-read caliper with accuracy to 0.001" and a range from one to six inches. Features an "adjust-to-zero" dial showing inches with an upper scale for millimeters and a thumb roller with lock. High-impact nylon gauge measures inside, outside, hole depth and comes in a hard plastic case. Made in Switzerland.

Stock #	Length	Maximum Opening	
B. GAU-167.00	8 ³ / ₄ "	6" (150mm)	\$38.40

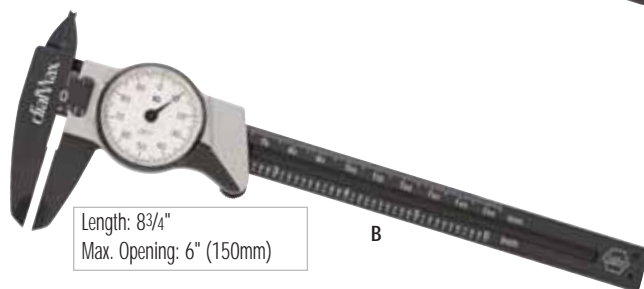
**STAINLESS STEEL DIAL CALIPER**

This value engineered caliper measures inside, outside and depth. The gauge is accurate to 0.02mm, with a measuring range of 0mm to 150mm. Features an easy-to-read "adjust to zero" dial and thumb-roller action with lock.

Stock #	Length	Maximum Opening	
C. GAU-177.00	9 ³ / ₈ "	6" (150mm)	\$40.22

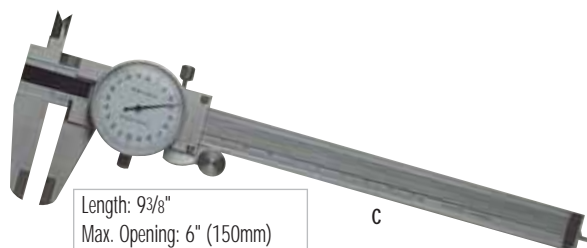
**PLASTIC DIAL CALIPER**

Our tough plastic dial caliper has a maximum range of 150mm with accuracy to 0.1mm. Measure inside, outside and hole depth and come in a tough protective plastic styrene case.

Stock #	Length	Maximum Opening	
D. GAU-184.00	9"	6" (150mm)	\$22.40

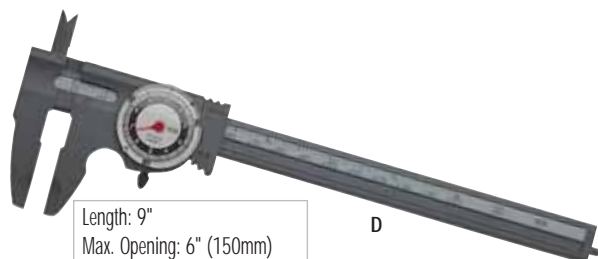
**NICKEL DIAL GAUGE**

For those who prefer an analogue gauge, this one measures 0-23mm with 0.1mm accuracy. Made of stainless steel for rugged use and three-way measurements. Case included.

Stock #		
E. GAU-194.00		\$99.00

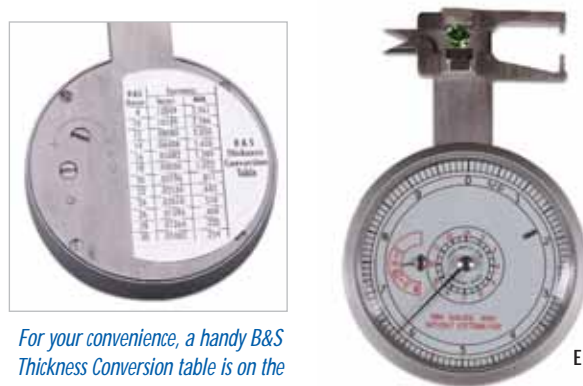

New! **PRESIDIUM**

PRESIDIUM® DIAL GAUGE

Cost effective way to accurately measure gemstones; delivers millimeter read out with instant carat conversion. One year warranty.

- Easy to use, easy to read.
- Measures 0.0-23mm, with .1 accuracy
- Conveniently measure loose or mounted stones.
- Protective pouch included.
- Includes gemstone weight estimation tables.

Stock #	
F. GAU-196.00	\$145.73





PRESIDIUM ELECTRONIC GEMSTONE GAUGE

Speed up your diamond and gemstone measuring with the high-tech Electronic Gemstone Gauge. Digital display eliminates eye fatigue when measuring stones over prolonged periods. Accurately measures 0–25mm with .01 mm accuracy – millimeter to carat conversion. One year warranty.

- Includes battery and carrying case.
- Auto shut off.
- Includes Presidium Gemstone Weight Estimation Tables.
- Touch button zeroing.

Stock #

A. GAU-198.10

\$286.54

PRESIDIUM GEM COMPUTER GAUGE

This precision gauge estimates the weight and identifies gemstones with great accuracy. This gauge will compute weight from either direct measurements or data entered directly through keypad entry. Features specific gravity dictionary – simply enter the name of the stone and retrieve the data. One year warranty.

- Measures 0–25mm, with .01mm accuracy.
- Features direct carat conversion for round brilliant cut diamonds.
- Power saving feature activated when placed on carrying case.
- Includes battery, software, USB cable and protective carrying case.

Stock #

B. GAU-198.50

\$322.57



DIGITAL CALIPER

Only the EURO TOOL digital caliper comes standard with a stone holding plate attachment for easy measuring of loose stones, watch crystals, beads, etc. With the touch of a button, you can convert measurements from millimeters to inches and back. Accuracy to .01mm. The measuring system is a non-contact linear CAP with LCD display and an auto-off system to save the battery. Caliper will measure inside, outside or depth and features a fine adjustment thumb wheel and zero set button. The EURO TOOL digital caliper comes in a protective nylon carrying case with foam padding and one spare battery.

Stock #	Length	Maximum Opening	
C. GAU-179.00	9 1/4"	6" (150mm)	\$75.00



MINIATURE DIGITAL CALIPER

Our stainless steel miniature digital gauge is state-of-the-art. Beautifully finished, it is practical and compact. It measures in millimeters and inches (maximum 100mm, 4 inches). Accuracy is assured at 0.01mm. Powered by a single 1.5 volt cell and protected in a high density plastic foam lined case.

Stock #	Length	Maximum Opening	
D. GAU-178.00	6 3/4"	4" (100mm)	\$39.95



COMPACT DIGITAL GAUGE

This compact digital gauge measures from 0-25mm (to two decimals) and 0-1" (to three decimals). Features:

- Cable port to download into printer.
- Flashing numbers when battery is low.
- Measures inside, outside and depth.
- Zero at any setting.
- Made of stainless steel with high impact nylon housing.
- Comes in a protective case.

Stock #

E. GAU-192.00

\$109.00



DIGITAL HIGH IMPACT 20MM GAUGE

This three button gauge measures down to an astounding three decimal places, mm or inches, zeros at any setting and is made of stainless steel with a non-glare high impact black nylon case. Also features auto shut-off. Case included.

Stock #

F. GAU-196.20

\$119.00

BOLEY-STYLE GAUGE

Pocket-size gauge gives quick measurement of inside or outside diameters in millimeters. Even works on mounted stones. Range of 0–100mm.

Stock #	Length	
A. GAU-161.00	145mm (5¾")	\$10.95

PRECISION SLIDING GAUGE

This excellent quality vernier caliper has finely honed jaws for exacting inside, outside and depth measurements. Features inch and metric calibration, with accuracy to 1/20 mm and 1/128".

Stock #	Length	Maximum Opening	
B. GAU-175.00	9¼"	150mm (6")	\$25.30

BRASS GAUGE DELUXE

An innovative gauge for measuring small stones, small parts, etc. Our Brass Gauge Deluxe eliminates the problem of holding while measuring. Just place stone or part on the metal underplate and get a fast, accurate measurement. Gauge works great for normal measurement too.

Stock #	Length	
C. GAU-170.80	80mm (3")	\$7.25

POCKET SLIDING BRASS GAUGES

This German-made gauge in solid brass offers a combination of inches and millimeters. It features notched jaws for inside/outside measurements and a 1/10 th millimeter vernier for accuracy.

Stock #	Length	
D. GAU-168.60	60mm (2½")	\$11.95
E. GAU-168.80	80mm (3")	\$11.95

VALUE BRASS GAUGES

This brass gauge is identical to the German models, but less expensive. The quality is such however that one can hardly tell the difference. It's made of solid brass and features notched jaws for inside/outside measurements as well as a 1/10 th millimeter vernier gauge.

Stock #	Length	
F. GAU-169.60	60mm (2½")	\$6.15
G. GAU-169.80	80mm (3")	\$6.15

PLASTIC POCKET GAUGE

Handy, lightweight millimeter pocket gauge from Switzerland is made of high impact nylon. Measures to 75mm. This gauge has a 1/10th millimeter scale for accuracy.

Stock #	Length	
H. GAU-172.00	80mm (3")	\$5.20

SPRING BAR GAUGE

Our new lug gauge gives you the exact measurement you need to determine the distance between watch lugs for spring bars, bands or bracelets. Made of stainless steel with permanently embossed lines and numbers, one side in millimeters, the other in inches. Also great for spacing beads.

Stock #	Length	
I. GAU-186.00	4¾"	\$3.95

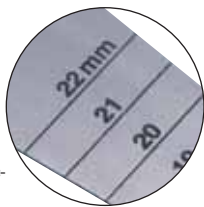
**STEEL RULER – INCH & MILLIMETER**

This fine steel ruler is useful for quick measurements or scribing lines and features a hole in one end for hanging. 12" ruler has inches on front and millimeters on back; smaller 6" ruler includes a handy conversion chart on the back – inches to millimeters.

Stock #	Length	
J. GAU-189.00	150mm (6")	\$2.95
K. GAU-189.10	300mm (12")	\$2.45

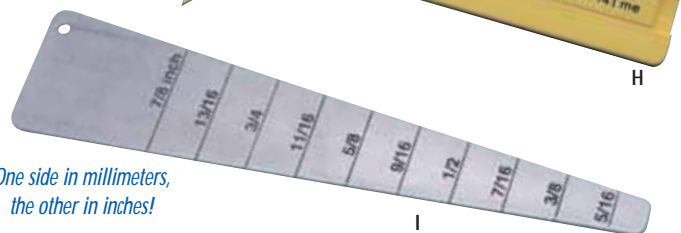
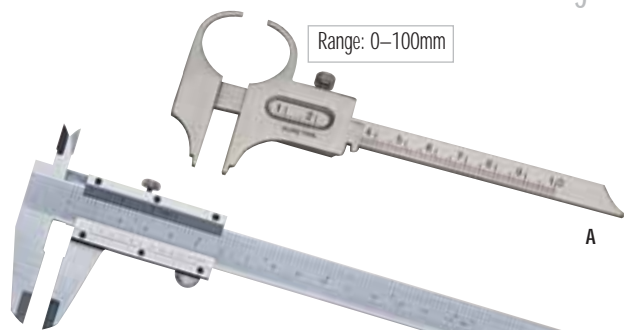

*One side in millimeters,
the other in inches!*



New!



A

GAUGE and RING STICK SET

A complete set to accurately size rings. Be assured of giving your customers an accurate fit every time with this ring and finger gauge set which has been matched in graduated and full sizes from 1-15. Includes a metal ring stick with wood handle and 29 individual rings. Rings are 6.5mm wide with the finger size clearly marked on each. The ring stick is hollow, nickel plated, graduated in quarter sizes and includes a gauge for material length needed to make specific size rings. Set comes complete in a wood storage box.

Stock #

A. GAU-265.00 \$45.95

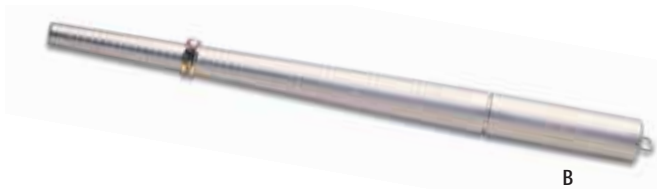

B

ALUMINUM RING STICK

This quality turned-aluminum stick measures size 1 to 15 by quarter size in U.S. standards. It features a metal loop at one end for hanging.

Stock #

B. GAU-345.00 \$13.30

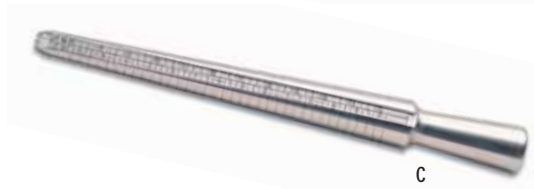

C

DELUXE ALUMINUM RING STICK

Deluxe version measures in European sizes, circumference in millimeters, American sizes and diameter in millimeters. It is also grooved for stone-set rings. Sizes 2 to 15.

Stock #

C. GAU-348.00 \$12.40



D

PREMIUM NYLON RING STICK

Premium version measures in European sizes, circumference in millimeters, American sizes and diameter in millimeters. Made of durable high-impact nylon to ensure no scratching. Sizes 2 to 15.

Stock #

D. GAU-349.00 \$4.95



E

METAL RING STICKS with ROSEWOOD HANDLES

Always-popular hollow ring sticks measure 1 to 15 by U.S. standards. At the narrow end, the gauge shows length of metal needed for sizing. The handle is elegantly polished rosewood with a loop for hanging.

Stock #

Stock #	Description	
E. GAU-350.00	Plain	\$14.75
GAU-351.00	Grooved	\$15.95



F

WOODEN RING STICK

This ring stick made of beautiful hardwood and finely finished is especially attractive for wirework because it will not scratch. Sizes 3 to 15, it is extremely accurate and shows off fine jewelry in a very sophisticated way. Because it is wood, it is less likely to damage glass counters or other surfaces.

Stock #

F. GAU-385.00 \$12.95



G

PLASTIC ECONOMY RING STICKS

Black plastic stick has large easy-to-read white markings which measure rings from size 1 to 15 by quarter sizes. This accurate and economical ring stick is great for use on glass showcases.

Stock #

Stock #	Description	
G. GAU-380.00	Grooved	\$4.95
GAU-380.50	Plain	\$4.95

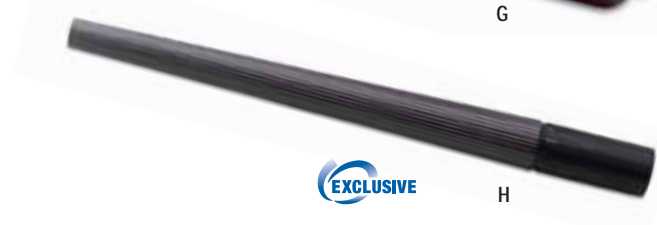

H

INDEXING MANDREL

Made of anodized aluminum, this mandrel has 36 lines, each 10 degrees apart. Excellent for designing eternity and other rings, because the user can divide rings into sections. This was designed by a master jeweler, Samuel Brown, for jewelers, and will become an indispensable tool for wax work or finished rings. Each mandrel comes with complete instructions. Size 1 to 13.

Stock #

H. GAU-340.00 \$23.50

EXCLUSIVE

FINGER GAUGES

Our gauges are nickel-plated for years of use at the retail level. Graduated in U.S. Standard half-sizes.

Stock #	Description	
A. GAU-250.00	Flat, size 1 to 15	\$13.95
B. GAU-251.00	Half-Round, size 1 to 15	\$13.55

WIDE FINGER GAUGE

The 7mm wide gauge is perfect for fitting wedding rings, class rings and other wide rings. It prevents resizing due to customers twisting narrow gauges over the knuckles. The gauge features sizes 1 to 15 in U.S. standards and is nickel-plated brass.

Stock #	Description	
C. GAU-253.00	Wide Flat, size 1 to 15	\$16.45

JUMBO FINGER GAUGE

Jumbo finger gauge, sizes 16-24 in half sizes. There are a lot of big guys out there, and we've been getting requests for larger finger gauges for some time now. So here they are made of nickel-plated brass and stamped with red numbers for easy reading.

Stock #	Description	
D. GAU-254.00	Jumbo, size 16 to 24	\$9.25

PLASTIC FINGER GAUGES

An inexpensive plastic gauge is great to "loan" customers. The plastic bands range from size 1 to 15 in U.S. standard sizes.

Stock #	Description	
E. GAU-255.00	Plastic, size 1 to 15	\$0.90
F. GAU-255.01	Plastic, Whole Sizes 1 to 15	\$1.10
G. GAU-255.50	Plastic, size 4 to 13, Made in USA	\$1.10

ALUMINUM RING SIZER

Lightweight aluminum finger gauge measures sizes 1-15. Half sizes are in blue, whole sizes are in silver. Inexpensive and easy on the eye.

Stock #	Description	
H. GAU-257.00	Aluminum Sizer, sizes 1 to 15	\$5.45

CREDIT CARD SIZED RING GAUGE

A "credit card" ring sizer that fits in your pocket! Your customer can inconspicuously take it home to measure a ring. It will close your sales with a perfect fit! Excellent for locations with multiple employees and available private labeled if requested. This brass sizer features a handy millimeter gauge on the end and comes in a convenient plastic pouch.

Stock #	Description	
I. GAU-355.00		\$13.95

POP-OUT RING SIZER

This economical plastic finger gauge is so practical. Each ring size is accurately made in the USA and removable so that prospective customers can take them for easy reference. Each ring is clearly marked in half sizes from 2 1/2 to 14. Made of light blue plastic, the entire unit measures 4 1/2" x 7 1/2" x 1/8". Easy to use, store and helps make the sale! Sold by the dozen.

Stock #	Description	
J. GAU-258.00	Plastic, size 2 1/2 to 14	\$3.60



A



B



C

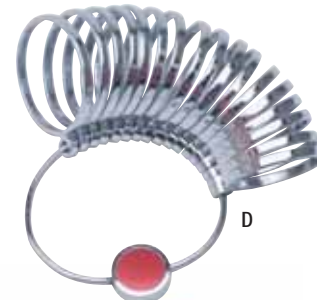

D



E

Inexpensive plastic gauge is great to "loan" customers!



F



G



New!



H



I



J

Pop-Out Ring Sizers are removable so customers can take them for easy reference.



Bracelet designed
by Fernando DaSilva

EZ SIZERS

EZ Sizers are a must for every beader. Make bracelets and necklaces that fit the first time every time. No more restringing, wasted beading wire, wasted crimps, or wasted time. Made of heavy roller polished vinyl for years of use. Lightweight and easy to take with you everywhere. Shipped flat, easy to assemble.

Stock #	Description	
A. GAU-110.00	EZ Bracelet	\$9.95
B. GAU-110.05	EZ Necklace	\$11.95
C. GAU-110.10	EZ Bracelet - Travel Size	\$8.95



METAL BRACELET GAUGE

Heavy steel sizing gauge made of "German silver" to accurately size bracelets/bangles. Adjustable band measures sizes from 5" to 9" in 1/4" increments.

Stock #	Description	
D. GAU-120.00		\$7.95



E. BANGLE/BRACELET GAUGE

Three sizes of bracelet gauges to enhance sales of bracelets and bangles. All are made of heavy gauge base metal, nickel-plated and securely attached to a handy 23/4" ring for safe-keeping.

- Small or baby: Sizes 1–9 for infants and children.
- Medium: Sizes 10–18 for small to medium teens and smaller adult wrists.
- Large: Sizes 19–27 for larger wrists and men.

Stock #	Description	
GAU-256.01	Small or Baby, sizes 1–9	\$8.25
GAU-256.02	Medium, sizes 10–18	\$8.55
GAU-256.03	Large, sizes 19–27	\$8.95

Bangle/Bracelet Gauge Conversion Chart

Gauge #	Diameter	Circumference	Gauge #	Diameter	Circumference	Gauge #	Diameter	Circumference
1	38.1	120mm	10	52.4	165mm	19	66.7	210mm
2	39.7	125mm	11	54.0	170mm	20	68.2	215mm
3	41.3	130mm	12	55.5	175mm	21	69.9	220mm
4	42.8	135mm	13	57.2	180mm	22	71.4	225mm
5	44.5	140mm	14	58.7	185mm	23	73.0	230mm
6	46.0	145mm	15	60.3	190mm	24	74.6	235mm
7	47.6	150mm	16	61.9	195mm	25	76.2	240mm
8	49.2	155mm	17	63.5	200mm	26	77.8	245mm
9	50.8	160mm	18	65.1	205mm	27	79.4	250mm

DEGREE GAUGE

For accurate measurements of stones and other small objects, try our stainless steel degree gauge. The points are precision ground and accurate to 0.10 millimeter, with a 10mm capacity. Marked on both sides.

Stock #

A. GAU-160.00 \$12.55

LARGE DEGREE GAUGE

Made of stainless steel with spring action, this gauge features a brass measuring slide, for measuring the outside dimensions of any object. The gauge is calibrated to 0.10 millimeter accuracy with a 15mm capacity. Precise and easy to read, the jaws are custom ground for true measurement.

Stock #

B. GAU-160.10 \$18.95

JO-DI GAUGE

Allows you to estimate the weight of all popular shapes of diamonds without removing the stone from the mounting. The only caliper gauge that reads round, emerald, pear and marquise shaped diamonds. Made of anodized black aluminum with clear numbers, it comes with a conversion booklet.

Stock #

C. GAU-165.00 \$36.10

PRO-VIDERS DELUXE

Our traditional round leg divider is quality constructed at a fraction of the cost of others. Each highly polished side comes to a fine even point. With a smooth working spring action adjustment, this divider will last for years. 3" leg length.

Stock #

D. DIV-330.00 \$24.95

PRO-VIDERS with REPLACEABLE TIPS

An excellent divider with replaceable tips made of extra hard tool steel in either 3" or 6". You will always have sharp dividers at your bench for marking or measuring. World class dividers which give the user extended life and exacting precision. This divider is high quality with a heavy duty spring and features a quick adjustment nut. Made in Germany.

Stock #	Description	
E. DIV-320.00	3" Divider w/ Replaceable Tips	\$11.90
F. DIV-326.00	6" Divider w/ Replaceable Tips	\$16.95
DIV-320.05	Tips (Sold per pair)	\$1.85

PRO-VIDERS

Pro-Viders answer the question: "Do you have a quality divider that doesn't cost a fortune?" Pro-Viders feature a quick-adjust setting nut and tempered points. Great for marking, finding centers and making circles. Our dividers are available in 3" size or 2 1/2" size. Unsurpassed quality. Made in Germany.

Stock #	Description	
G. DIV-300.00	3" Divider	\$11.90
H. DIV-310.00	2 1/2" Divider	\$11.95

ECONOMY DIVIDERS

Good quality, economy versions of our standard dividers. Easy-to-use with a quick-adjust setting nut.

Stock #	Description	
I. DIV-300.99	3"	\$5.35
J. DIV-400.99	4"	\$5.95

STEEL SQUARES

Milled to perfection at an exact 90° angle for perfect corners, centering stones and a wide variety of other uses.

Stock #	Length	
K. GAU-188.00	6"	\$4.95
L. GAU-188.03	3"	\$4.95
M. GAU-188.02	2"	\$4.45

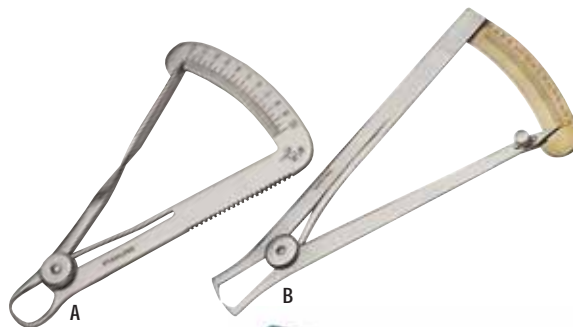

Replaceable tips available for extended tool life and exacting precision.

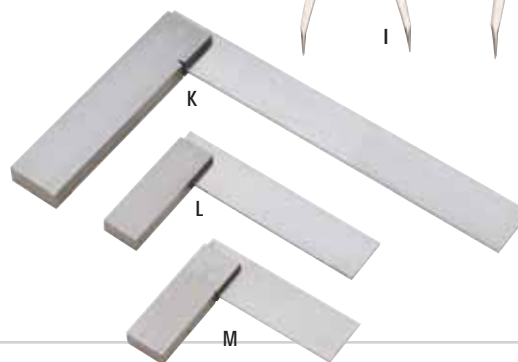

GRS is a manufacturer of the finest bench products and tools made anywhere in the world. Anyone who does stone setting and engraving should consider investing in the GRS line of tools and equipment. Without question, GRS tools will enable one to work more productively with far less fatigue than with conventional tools. With the superior control of GRS tools, the craftsmen will excel at precision work. EURO TOOL proudly offers this fine line of bench tools as well as GRS books, videos and a variety of bench accessories. Shown herein is just a sampling of the GRS line of products. Ask for a complete catalog of all GRS items.

BENCHMATE

BenchMate is a powerful holding system that stabilizes stone setting, speeds up soldering and simplifies jewelry repair. BenchMate reduces the hand force needed to set stones. You can set more stones per day and do a nicer job with less strain and greater confidence. This patented system keeps your work centered in front of your bench at the right height. You'll maintain good body posture for greater comfort throughout the day.

BENCHMATE BASIC

Includes Basic Benchmate Holder, shellac pad, fixed mounting plate and hardware.

Stock #	
A. G04-542	\$198.00

BENCHMATE DELUXE

Includes Basic BenchMate Holder, shellac pad, narrow and wide solder fingers, third-hand attachment, bench pin kit, fixed mounting plate and hardware.

Stock #	
B. G04-555	\$269.00

BENCHMATE PLUS

Includes Basic Benchmate Holder, shellac pad, narrow and wide solder fingers, two third-hand attachments, bench pin kit, 4" solder station, fixed mounting plate and hardware.

Stock #	
C. G04-571	\$328.00

SETTER'S PACKAGE

Includes Basic Benchmate Holder, shellac pad, bench pin kit, inside ring holder, fixed mounting plate and hardware.

Stock #	
D. G04-674	\$289.00

BENCHMATE ACCESSORIES

Stock #	Description	
E. G04-556	Bench Pin Kit	\$23.95
F. G04-557	Fixed Mounting Plate	\$15.98
G. G04-559	Optional Mounting Adapter	\$23.00

THIRD HANDS for BENCHMATE

Includes two removable standard third-hands and 6" (150mm) square solder board. Sits on a bench or fits BenchMate fixed mounting plate.

Stock #	Description	
H. G04-568	Standard Third-Hand on Weighted Base	\$44.75
I. G04-570	Double Third-Hand Soldering Station	\$99.95

INSIDE RING HOLDER FOR BENCHMATE

Includes holder body, 7 collets, expansion screw and wrench.

Stock #	
J. G04-589	\$69.00

GRS METAL FORMER

Easily shape copper, silver and gold bracelets with the GRS Metal Former. Form flat strips of metal to a perfect "C" shape after you have engraved your design. To shape a bracelet, place one end of the material under the die and press down on the handle. Continue to work the material through the former, shaping as you go, until you have reached the desired shape. The unit comes with two different fixed punch sizes and with one adjustable die cavity. With these punches and die, .25" up to 1.25" wide bracelets can be formed. Recommended for soft metals such as copper, silver, and gold alloys with a thickness of .030" to .080".

Stock #	
K. G04-725	\$199.00

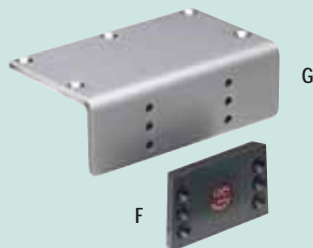

GRS ENGRAVING BLOCKS

Engraving Blocks are specially designed for handwork including engraving, jewelry making, wood carving, precision assembly and more. These two flexible workholders are very stable yet easily maneuvered while you work. Self-centering jaws have tooling holes that accept a variety of pins and attachments. The top half of each vise rotates smoothly about its center. The spherical bottom sits in a socket ring so you can tilt it in any direction.

Stock #	Description	
A. G03-530	GRS Standard Block	\$388.00
G03-531	GRS Standard Block w/ 30pc Attachment Set	\$448.00
B. G03-021	GRS Magnablock	\$498.00
G03-522	GRS Magnablock w/ 30pc Attachment Set	\$549.00



MICROBLOCK™ BALL VISE

Like larger GRS vises, the MicroBlock is machined from solid stainless steel and finished with a special low glare treatment to reduce eye strain. It features a self-centering jaw system and an adjustable internal brake system that allows the user to choose the amount of rotational resistance. The MicroBlock's low profile and compact design is especially suited for microscope work or other situations where the size of a larger vise is an obstacle.

Stock #	Description	
G03-683	GRS MicroBlock Ball Vise	\$228.00
C. G03-684	GRS MicroBlock Ball Vise with 30-piece Attachment Set	\$288.00



30 PIECE ATTACHMENT SET FOR ENGRAVING BLOCKS

Includes leather-faced ring clamps plus a variety of pins and other clamps that fit the upper jaw plates of every GRS Block. These 30 pieces help you instantly solve the problems of holding, so you can start working.

Stock #		
D. G03-520		\$78.00



INSIDE RING HOLDER (for vises)

This lets you hold rings from the inside like the BenchMate inside ring holder. It works with all GRS Blocks and most vises. Great for stone setting and ring engraving. For extra wide rings, get another collet set and "double-stack" the collets.

Stock #		
E. G04-679		\$43.95



Request a GRS Catalog for the complete line of quality GRS Tools.

DIAMOND POWER HONE

GRS Power Hone uses diamond wheels to sharpen hardened steels, high speed steels and carbides. You can now choose the best tool material for each job because you can sharpen them all. The wheels last for years and stay flat for accuracy. Different grits are available from coarse to mirror polishing. With its heavy steel housing, continuous-duty motor and double-bearing spindle, the GRS Diamond Power Hone is a sharpener you can depend on for years. And, you'll find it remarkably easy to use.

Stock #	Description	
F. G01-525B	Power Hone with 600 Diamond Wheel (115 Volt, 60Hz, 1.3Amp)	\$379.00
G02-138	Diamond Wheels - 260 Grit (coarse)	\$97.00
G02-055	Diamond Wheels - 600 Grit (medium)	\$89.00
G02-139	Diamond Wheels - 1200 Grit (fine)	\$89.00
G. G03-570	Dual Angle Sharpening Fixture	\$198.00



Great Value!

**SUPER NEW GLUE**

Now available exclusively through EURO TOOL, Super New Glue has a different formula than other super glues giving it superior holding quality, even under the toughest conditions. New Glue is made in the USA. Each bottle holds 3 grams.

Stock #	Description	
A. GLU-100.00	3 gram Bottle	\$1.89
B. GLU-100.01	25pc Display	\$47.22

G-S HYPO JEWELER'S CEMENT

Precision applicator allows maximum control with this jeweler's cement. Traditionally used for plastic or glass watch crystals but also great for bead stringing. Non-brittle, dries clear.

Stock #	Description	
C. GLU-105.00	Net wt. 1/3 oz.	\$5.00

G-S HYPO FABRIC CEMENT

An adhesive with needle-point application which allows the precise amount to be applied to intricate textile and fabric projects. This fabric cement is ideal for textiles, beading, leather, plastic, and other arts and crafts projects. Dries clear with no mess, no waste and will not bond fingers.

Stock #	Description	
D. GLU-106.00	Fabric Cement	\$5.00

HENRIETTA'S GUM ARABIC

Used to make self-threading needles and seal closing knots. This water soluble formula washes off of hands, tools and beads easily. Directions conveniently on the label. Now available in a non-breakable plastic container.

Stock #	Description	
E. GLU-110.00	Net wt. 1/2 oz.	\$3.95

UV GLUE with TIP

Clear crystal adhesive that cures under ultraviolet light or direct sunlight. Tube contains .07 fluid ounces. Special tip for precise application puts glue on uniformly with ease. GLU-113.00 offers a lighter viscosity than the standard UV Glue.

Stock #	Description	
F. GLU-112.00	UV Glue	\$7.95
GLU-112.01	Extra Tip	\$1.20
G. GLU-113.00	UV Glue - Light Viscosity	\$8.25

EPOXY 220 and EPOXY 330

Epoxy 220, amber-clear glue, line bonds with a slow setting time for production bonding of gem materials to metal findings. Used in electronic and mechanical industries for superior bonding of non-porous components. Epoxy 220 has ultimate tensile strength, resists thermal shock and takes a high polish for inlay.

Epoxy 330, water-clear glue, line bonds with fast setting time. Used to bond gem materials to metal findings and takes a high polish for inlay. It can also be used for invisible bonding of glass, china, ceramics, stone, metals and other non-porous materials. Thickens in 15 minutes and hardens in 2 hours. Hardens in 10 minutes under a heat lamp.

Stock #	Description	
H. GLU-202.20	Epoxy 220 - Two 1/2 fl. oz. Tubes	\$3.95
I. GLU-203.30	Epoxy 330 - Two 1/2 fl. oz. Tubes	\$3.95

ELFY SUPER GLUE

A super glue for today! This imported glue has phenomenal bonding power and comes in a handy display package. A high quality cyanoacrylate, Elfy is priced very competitively and features a non-drip spout and cap which keeps the tip dry and clean. Elfy is transparent and colorless and dries in approximately 30 seconds. Gel formula offers a thicker viscosity that will not drip or "bleed" as easily. A EURO TOOL exclusive. Net weight 0.11 fl. oz.

Stock #	Description	
J. GLU-807.00	Elfy Super Glue Gel	\$1.90
K. GLU-808.00	Elfy Super Glue	\$1.65

E-6000®

E6000 is an industrial, high performance adhesive that is ideal for jewelry and beading applications. It provides a superior bond on porous and non-porous materials such as metal, plastic, glass, rubber, tile, marble, ceramic, vinyl, fabric, leather and wood. Maintains adhesive strength even when submerged under water. Abrasion resistant so may be used on high-wear surfaces. Dries clear and is paintable.

Stock #	Description	
L. GLU-600.00	E6000 Adhesive - 3.7oz Tube	\$5.75
GLU-600.01	E6000 Adhesive - 1 oz. Tube	\$2.99

DEVCON EPOXY

Devcon epoxy adhesive cures and joins materials together by a chemical reaction between the resin and hardener. This reaction results in a high strength bond that is resistant to most chemicals. Use Devcon Epoxy adhesive for household, industrial, crafts or for any job that requires a high-strength, high-quality bond. Works best on metal, wood, concrete, glass, ceramics, china and much more. Available in fast setting 5 Minute or super strong 2-Ton. **5 Minute Epoxy** sets in 5 minutes with strength up to 1,500 lbs. per square inch. **2-Ton Epoxy** sets in 30 minutes with strength up to 2,500 lbs. per square inch. Dries clear; waterproof.

Stock #	Description	
A. GLU-720.80	5 Minute Epoxy – 1 oz. Syringe	\$4.85
B. GLU-720.50	5 Minute Epoxy – Two 1/2 oz. Tubes	\$3.95
C. GLU-720.60	5 Minute Epoxy – Two 1 1/4 oz. Tubes	\$5.95
D. GLU-720.90	5 Minute Epoxy – Two 4 1/2 oz. Bottles	\$15.95
E. GLU-731.00	2-Ton Epoxy – 1 oz. Syringe	\$3.95
F. GLU-735.00	2-Ton Epoxy – Two 1/2 oz. Tubes	\$3.57
G. GLU-735.90	2-Ton Epoxy – Two 4 1/2 oz. Bottles	\$14.99



METAL PATCH AND FILL COMPOUND

This rustproof compound works great on all types of metals. Seals, fills and bonds. Use for repairing worn, rusted or corroded metal. Use to build up worn surfaces. Resistant to oil, water, gasoline and most chemicals. Can be drilled, sanded or painted. Cures to a gray finish.

Stock #	Description	
H. GLU-750.00	Net wt. 3.5 oz.	\$3.85

SUPER GLUE II

An all-purpose glue that works best on: hard plastic, metal, rubber, china, ceramics, fabric, leather and more. This low odor formula sets in 15 seconds, dries clear giving a super strong bond. Works well on porous materials.

Stock #	Description	
I. GLU-729.10	Net wt. 2g.	\$1.95

SUPER GLUE GEL

Provides a fast, strong and permanent bond to almost all non-porous and semi-porous surfaces such as hard plastic, metal, rubber, china, ceramics, fabric, leather and more. Just one drop per square inch needed. Super Glue Gel is a low odor, no drip formula that sets in 60 seconds and dries clear giving a super strong bond and less waste. Excellent value; easy to apply.

Stock #	Description	
J. GLU-730.00	Net wt. 2g.	\$2.19



TENAX ADHESIVE

This water-clear super glue is designed to bond stones, ceramics, glass, porcelain, metals, rubber and some plastics. It is not recommended for use on wood, paper, cloth, polyethylene and teflon. Its quick bonding action requires no clamping or mixing. The parts to be joined must match as Tenax is not a gap filler.

Stock #	Description	
K. GLU-207.00	Net wt. 1/4 fl. oz.	\$3.90



DUCO CEMENT

The most popular multi-purpose glue dries clear and fast. Great on china, glass, plastic, wood, metal and crafts. Unique dispenser tip allows for precise accuracy. It is easy to apply and is dishwasher safe.

Stock #	Description	
L. GLU-762.43	Net wt. 1 fl. oz.	\$2.50



ATTACK® SOLVENT

Used for clean up and to separate misaligned bonded materials of cured epoxy and polyester resins from metal, stone, glass, wood and similar materials without damage to the surface.

Stock #	Description	
M. GLU-250.00*	Net wt. 8 fl. oz.	\$10.25
GLU-250.50*	Net wt. 1/2 Gallon	\$37.90

*Cannot be shipped by air.



A

TAKE NOTE

There are cheaper chasing hammers available, but ours are better engineered with a metal wedge and oblong hole in the head to assure that handles do not loosen and twist. So in the long run, you'll be happier with our quality, aside from years of service.

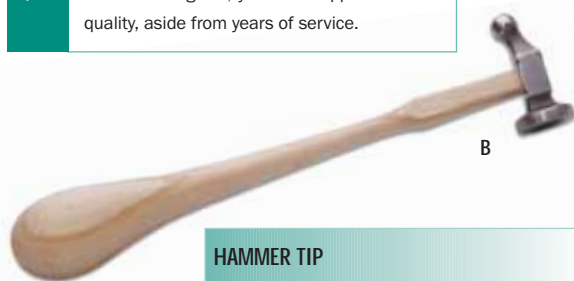

B

HAMMER TIP

If you are in a dry climate where wood shrinks and the handle becomes slightly loose, simply put the head in a jar of anti-freeze overnight and it will tighten and stay tight.



CHASING HAMMERS

Chasing hammers have a large face for striking chasing tools or flattening. The pein side is for riveting and metal design. The forged head is wedge-mounted on a hardwood handle. Our chasing hammers are without question the best in this price range. Slightly rounded faces with an overall length of 11".

Stock #	Face Dia.	Head Weight	
A. HAM-150.00	25mm (1")	3 oz.	\$12.15
HAM-151.00	28mm (1 1/8")	4 oz.	\$12.75
HAM-152.00	32mm (1 1/4")	6 oz.	\$13.85



CHASING HAMMERS

Our new "German Style" chasing hammer is a high quality tool. The handle is hardwood featuring a wedge and oblong hole to keep the head from turning. The large face is flat and the pein side is slanted for better ergonomics when striking metal. This is a more popular style with European silversmiths, and preferred by many worldwide. The head is high grade stainless steel which has been case-hardened for long life.

Stock #	Face Dia.	Head Weight	
B. HAM-160.00	25mm (1")	3 oz.	\$12.80
HAM-161.00	28mm (1 1/8")	4 oz.	\$13.40
HAM-162.00	32mm (1 1/4")	6 oz.	\$14.60
HAM-160.50	Handle Only		\$4.25

BALLPEIN HAMMERS

Made of drop-forged steel, mounted on hardwood handles and secured with a metal wedge.

Stock #	Length	Weight	
C. HAM-430.01	8 5/8"	2 oz.	\$4.40
HAM-431.00	10 3/8"	4 oz.	\$5.90
HAM-430.08	10 1/2"	8 oz.	\$6.45

BRASS HAMMER

This small brass hammer with hardwood handle will give the user years of service. The head is 5/8" diameter and weighs 3 oz. You'll like the balance and feel of this quality hammer.

Stock #	Length	
D. HAM-215.00	9 1/8"	\$6.95

BRASS HAMMER DELUXE – FLAT/BALLPEIN

This 2 oz. hammer features a superb quality solid brass head threaded onto an anodized aluminum handle. A special compound is used to assure the head cannot release. The handle is hex-shape to prevent slipping. Made in USA.

Stock #	Length	
E. HAM-130.00	8"	\$13.30

RIVETING HAMMERS

One end is flat for general purpose and the other is chisel-shaped for spreading rivet heads. Handles are seasoned ash. Two models to choose from, both made in Germany.

Stock #	Face Dia.	Head Length	Weight	
F. HAM-200.00	Round, 3/8"	3"	2.5 oz.	\$22.00
G. HAM-202.00	Square, 1/2"	3"	4 oz.	\$11.75

GOLDSMITH HAMMER

The black 3.5 oz. head is 3" long with a 5/8" (16mm) polished face. Our hammer has a hardwood handle and is made in Europe for years of service because it is drop-forged and case-hardened.

Stock #	Length	Head Length	Weight	
H. HAM-210.00	12"	3"	3.5 oz.	\$28.30

SWISS-STYLE HAMMER

Small, handy Swiss-style hammer for riveting, shaping, etc. A must for light precision work.

Stock #	Length.	Head Length	Weight	
A. HAM-212.00	9 ¹ / ₈ "	2 ³ / ₄ "	2 oz.	\$4.85

NYLON HAMMERS

Our German-made hammers with nylon faces offer the best in quality and value. Each hammer has a seasoned ash handle with a drop forged head and two durable nylon faces. Spare faces are available by the pair in high-impact nylon and simply come off with a half-turn.

Stock #	Description	
B. HAM-360.05	7/8" (22mm) Face Diameter Nylon Hammer	\$10.75
C. HAM-365.05	1 ¹ / ₁₆ " (27mm) Face Diameter Nylon Hammer	\$12.45
HAM-360.15	7/8" (22mm) Replacement Faces - pair	\$3.55
HAM-365.15	1 ¹ / ₁₆ " (27mm) Replacement Faces - pair	\$4.40

HAMMERS with DETACHABLE FACES

Mallets with interchangeable faces and shellacked hardwood handle. Replacement faces available to allow any combination of brass, nylon or fibre. Face diameter 5/8". Overall length 9¹/₄".

Stock #	Description	
D. HAM-370.04	Brass & Fibre Hammer, 4 oz.	\$9.89
E. HAM-370.05	Brass & Nylon Hammer, 4 oz.	\$9.89
HAM-370.10	Brass Insert	\$1.25
HAM-370.14	Fibre Insert	\$1.25
HAM-370.15	Nylon Insert	\$1.25

Caution: Always wear proper face and eye protection.

HAMMER with FOUR FACES

This larger hammer offers the user several good options. Sold as a "kit", it features interchangeable nylon, brass, fiber and rounded brass faces for multiple uses. Additional faces sold separately.

Stock #	Description	
F. HAM-372.04	Kit with Four Faces	\$19.95
G. HAM-372.10	Brass Face Dome	\$3.70
H. HAM-372.11	Brass Face Flat	\$3.70
I. HAM-372.14	Fiber Face Flat	\$3.50
J. HAM-372.15	Nylon Face Flat	\$3.50

LARGE NYLON WEDGE HAMMER

This new addition to our line features a nylon head with one face 1¹/₄" round and slightly domed used to flatten and shape sheet and wire with no risk of marring. The other side is wedge shaped for working tight areas.

Stock #	Length.	Head Length	Weight	
K. HAM-393.00	10 ³ / ₄ "	4 ³ / ₄ "	7 oz.	\$10.50

PLASTIC MALLETS

Our plastic head mallet is made of a non-porous material that will not mar and is easily cleaned. Excellent for applications with precious metals where marring is a problem. The seasoned hardwood handle gives the user a sure grip.

Stock #	Size	Face	Head Weight	
L. HAM-411.00	1	1 ¹ / ₄ "	4 oz.	\$9.90
HAM-412.00	2	1 ¹ / ₂ "	6 oz.	\$10.50
HAM-413.00	3	1 ³ / ₄ "	9 oz.	\$11.95

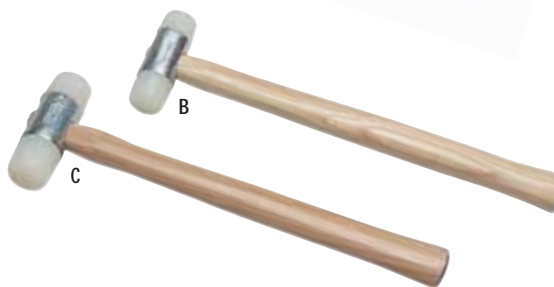

Replacement faces available in brass, nylon or fibre.

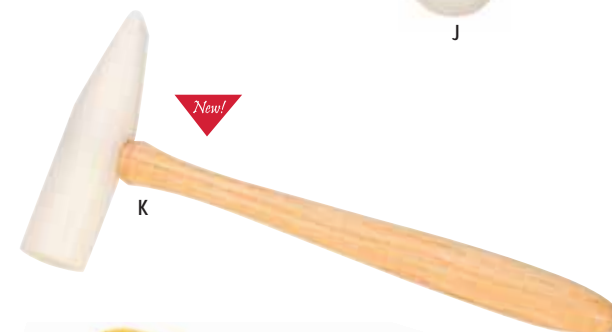
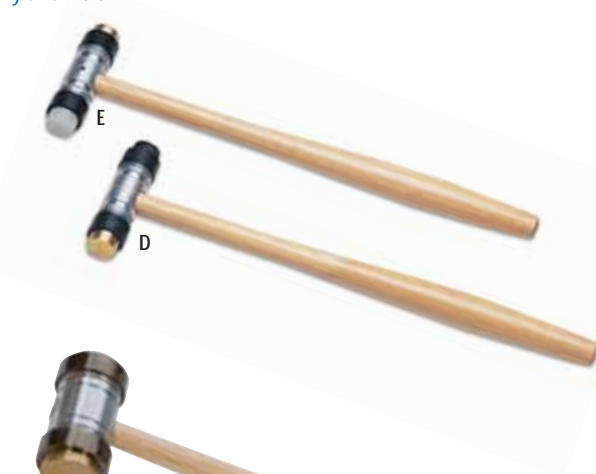

EXCLUSIVE

**TEXTURING HAMMERS**

Texturing hammers for non-ferrous metals. Our double-sided hammers enable the user to make attractive patterns to give jewelry and other metal items a special look. Two different patterns with each hammer. Just place sheet metal on a flat metal block or anvil and strike sharply. In no time you will have interesting patterns. Hammers have a Rockwell hardness of 48, and the more the hammer is used, the more interesting the patterns become. Let your imagination take over – our hammers will provide you with a simple and easy method to give your finished piece that extra flair.

Stock #	Description	Length	Face Dia.	
A. HAM-460.01	Checkered/Wide Stripe	10"	1 1/8"	\$19.95
B. HAM-460.02	Narrow Sharp Stripe/Dimples	10"	1 1/8"	\$19.95
C. HAM-460.03	Crosshatch/Stars	10"	1 x 3/8"	\$19.95

Stock # HAM-460.01

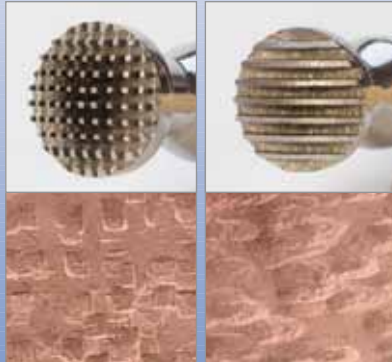

Checkered

Wide Stripe

Stock # HAM-460.02

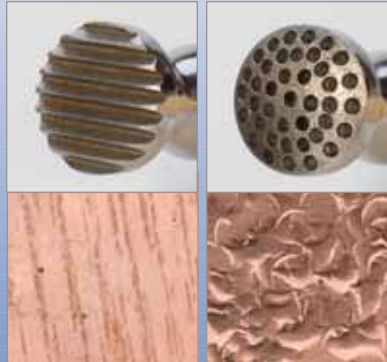

Narrow Sharp Stripe

Dimples

Stock # HAM-460.03



Crosshatch

Stars



Copper sheet and shapes available on page 107 and 238.

**HEAVY BRASS HAMMERS**

Our new hammers feature a solid brass, one or two pound head. The brass head is secured onto a smooth hardwood handle. A brass hammer of this size is perfect for hammering ferrous or non-ferrous metals, and is excellent for stamping and dapping. The heavy brass head gives the user a nice "dead blow" effect which assures better performance when dapping or stamping.

Stock #	Weight	Face Dia.	Total Length	
D. HAM-455.10	1 lb.	1"	12 1/2"	\$22.95
E. HAM-455.20	2 lb.	1 1/2"	12 1/2"	\$32.50

F. WEIGHTED RAWHIDE MALLET

This mallet is made of high grade rawhide, excellent for flattening and shaping soft metals without marring. The handle is seasoned hickory and the heads are lead filled for extra weight and nice "dead blow" which gives them greater striking efficiency for certain applications. Made in the USA.

Stock #	Size	Face Dia.	Head Weight	
HAM-407.00	7	1 1/4"	8 oz.	\$23.25
HAM-408.00	8	1 1/2"	12 oz.	\$24.42
HAM-409.00	9	1 3/4"	16 oz.	\$27.30
HAM-410.00	10	2"	20 oz.	\$33.92

G. DELUXE RAWHIDE MALLET

Our mallets are American-made of the finest rawhide impregnated with shellac. Used for stamping and hammering metals which must not be scratched. The handle is made of select ash.

Stock #	Size	Face Dia.	Head Weight	
HAM-420.00	0	1"	2 oz.	\$14.65
HAM-421.00	1	1 1/4"	4 oz.	\$16.55
HAM-422.00	2	1 1/2"	6 oz.	\$19.55
HAM-423.00	3	1 3/4"	9 oz.	\$24.90
HAM-424.00	4	2"	11 oz.	\$28.95

DELUXE SCALPEL HANDLE

High-quality handle has a thick, non-slip PVC coating for continual comfort. It is the perfect tool to use with our Swann-Morton blades. A EURO TOOL original. 5" length.

Stock #		
A. KNF-225.00		\$4.95

STAINLESS STEEL SCALPEL HANDLE

Quality-made stainless steel scalpel handle holds scalpel blades for mold cutting applications and more. 5" length.

Stock #		
B. KNF-220.00		\$3.65

PLASTIC SCALPEL HANDLE

Securely hold scalpel blades with this durable molded plastic handle. 5" length.

Stock #		
C. KNF-221.00		\$3.35

SCALPEL BLADES

Use the finest, Swann-Morton! These blades, made in England, are extremely sharp and of the highest quality surgical steel. Sold 100 blades per box. Priced per piece.

Stock #	Description	
D. KNF-235.10	Blade Style #10	\$0.25
E. KNF-235.11	Blade Style #11	\$0.25
F. KNF-235.12	Blade Style #12	\$0.25
G. KNF-235.15	Blade Style #15	\$0.25

ECONOMY SCALPEL BLADES

Carbon steel surgical blades priced and sold in boxes of 100.

Stock #	Description	Qty	
KNF-245.10	Blade Style #10	bx/100	\$16.45
KNF-245.11	Blade Style #11	bx/100	\$16.45
KNF-245.12	Blade Style #12	bx/100	\$16.45
KNF-245.15	Blade Style #15	bx/100	\$16.45

SOFT-GRIP KNIFE

This is the most popular style knife of its type. Now it's improved with a soft-grip handle. New technology assures sharper blades of better temper than ever before. Comes with standard No. 11 blade, but any and all shapes are available. Blades sold five per pack. Handle length 4 3/4".

Stock #	Description	Qty.	
H. KNF-280.00	Soft-Grip Handle w/ #11 Blade		\$3.95
I. KNF-280.10	Blade #10	pk/5	\$2.35
J. KNF-280.11	Blade #11	pk/5	\$1.50
K. KNF-280.12	Blade #12	pk/5	\$2.15
L. KNF-280.13	Blade #13	pk/5	\$2.35
M. KNF-280.16	Blade #16	pk/5	\$1.50

SAFETY BLADE REMOVER

The safest way to remove used scalpel blades. Just insert the blade into the box, push down on the tab and pull the scalpel handle. Blade remains safely in the box. Used blades and box can be discarded when the box is full.

Stock #		
N. KNF-100.00		\$2.50

O. CUTTING MATS

We offer two sizes of triple layered mats for work and home plus a smaller, extra thick single layer mat ideal for craft kits. Each mat is a self-healing material which enables the user to cut more accurately without dulling blades.

Stock #	Size	Color	
KNF-103.00	5" x 7"	White	\$3.95
KNF-105.00	8 1/2" x 12"	Green	\$10.60
KNF-107.00	12" x 18"	Green	\$17.55



We offer both Swann-Morton blades as well as a carbon steel economy version - both priced to fit a variety of needs.



Safely removes and disposes used blades.

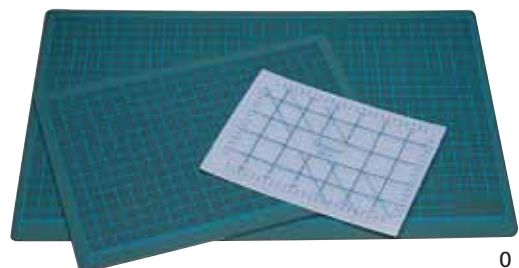



A

BENCH KNIFE

This traditional bench knife works well for many purposes, especially scraping and prying. The sturdy stainless steel blade, mounted in a hardwood handle shaped to fit the hand, stands up well to rugged utility use. Length is 6" (150mm).

Stock #

A. KNF-967.00

\$3.80



B

DELUXE BENCH KNIFE/CASE KNIFE

Deluxe bench knife features riveted handle and tempered blade. Excellent for opening watch cases. Length is 5 1/4" (135mm).

Stock #

B. KNF-970.00

\$3.35



C

CASE OPENING KNIFE

This universally popular shape gives watchmakers the small handle necessary to properly grip when prying open snap-on case backs. Hardwood handle and a precisely beveled, tempered steel blade makes case opening easier. Total length of the knife is 4 1/2" (115mm).

Stock #

C. KNF-975.00

\$4.65



D

CASE KNIFE

Sturdy German-made case knife features a comfortable red cushion grip PVC handle which gives the user excellent leverage. The blade has a single bevel edge for removing those difficult case backs. Material is well-tempered tool steel. Total length 4 1/2" (115mm).

Stock #

D. KNF-158.00

\$15.95



E

SNAP-BACK CASE KNIVES

Special Swiss case knife is 4" long with hard plastic handle and tempered blade. Fixed blade does not fold into handle. The economy or deluxe model is perfect to include as part of a battery change kit or to use for other applications where price is the issue.

Stock #

Description

E. KNF-156.00

Swiss Model

\$20.95

F. KNF-156.50

Deluxe Model

\$7.95

G. KNF-160.00

Economy Model

\$4.95



F

SWISS POCKET KNIFE

Made in Switzerland by the maker of the famous Swiss Army Knife, our knife is excellent for all-purpose use. Closed length is 3 1/2", and the knife features stainless steel blades and anodized handle. Short blade is for opening watch cases. Be careful, the longer cutting blade comes extremely sharp!

Stock #

H. KNF-883.00

\$25.95



H

See our complete line of watch case tools – page 223-233.



TUNGSTEN CARBIDE DRAWPLATES

Professional quality and the ultimate in drawplates. Tungsten carbide inserts are permanently fixed in marked steel plates. The angle of reduction is made to exact specifications for the smoothest possible pull.

Stock #	# of Holes	Hole Sizes	
A. DRA-552.00	24	1.00mm – 0.26mm	\$62.95
B. DRA-553.00	24	6.00mm – 2.30mm	\$79.95
C. DRA-555.00	39	2.80mm – 0.26mm	\$75.00

PREMIUM STEEL EURO DRAWPLATES

Premium steel drawplates are for drawing down wire. The quality is the best available with smoothly machined holes. Made in Italy.

Stock #	# of Holes	Hole Sizes	
D. DRA-572.00	31	2.00mm – 0.30mm	\$62.35
DRA-574.00	31	3.00mm – 0.50mm	\$62.35

STEEL DRAWPLATE - VALUE SERIES

82-hole drawplate has holes starting at 2.50mm, going down to 0.12mm. Each hole is round and highly polished.

Stock #	# of Holes	Hole Sizes	
E. DRA-410.00	82	2.50mm – 0.12mm	\$12.25

SPECIAL SHAPE DRAWPLATES - VALUE SERIES

Five different shapes to meet any special requirements. Economical quality, which offers great versatility. 8 1/2" long.

Stock #	# of Holes	Hole Sizes	Shape	
F. DRA-410.10	30	4.10mm – 1.65mm	Square	\$9.95
G. DRA-410.15	30	6.00mm – 2.30mm	Triangle	\$9.95
H. DRA-410.20	30	3.60mm – 1.25mm	Oval	\$9.95
I. DRA-410.30	30	4.00mm – 1.70mm	Teardrop	\$9.95
J. DRA-410.40	30	5.50mm – 2.70mm	Half-Round	\$9.95

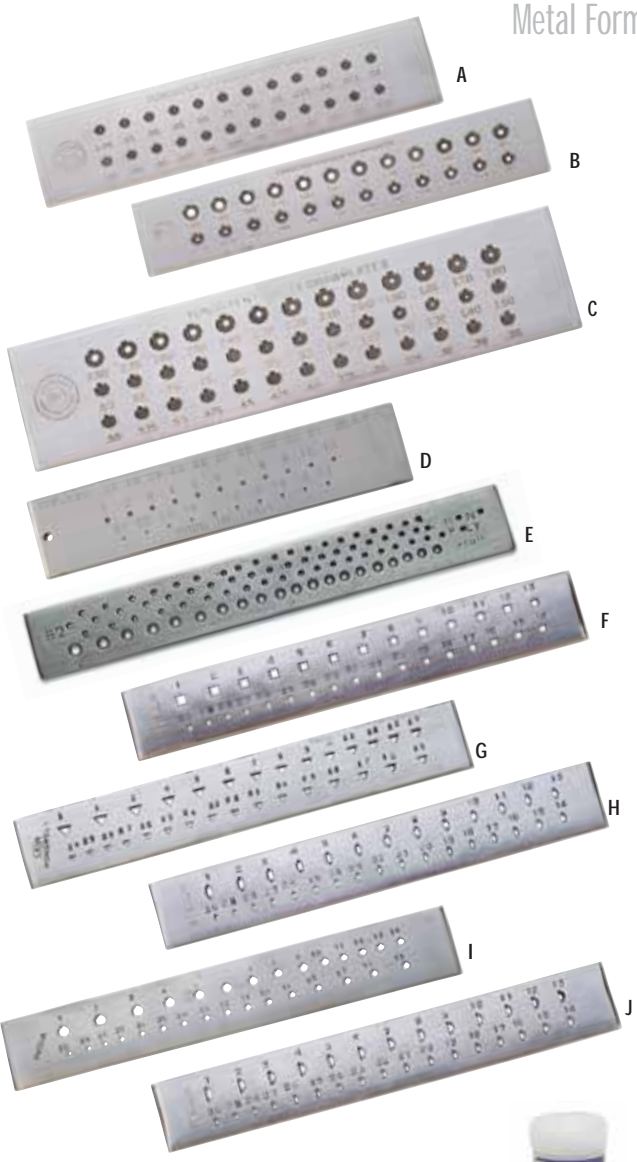

ROSEWOOD DRAWPLATE

This handy tool is designed for reducing soft chain or woven chain. Made of hard boxwood with smooth holes, the user simply pulls the material through consecutively smaller holes reducing the size of the chain. Note that on one side of the block the holes are slightly chamfered to facilitate pulling the wire through. User may put the "tang" of the block into a vise, or hold it by hand. Measures 3 1/2" x 2 1/2" x 3/4".



Stock #	# of Holes	Hole Sizes	
K. DRA-120.00	12	1.2mm – 6.5mm	\$10.95

DRAWTONGS

Drawtongs have serrated jaws to provide an excellent grip when drawing wire. The properly shaped handles insure a good continuous hold.

Stock #	Length	Jaws	
L. DRA-678.00	8"	1" x 1/2"	\$18.95
DRA-680.00	10"	1 1/4" x 3/4"	\$19.95



For faster and easier drawing of wire, use a small amount of Cut Lube – page 44.

80MM ROLLING MILL

This mill is economical but excellent quality at this price. Well-machined, the rollers are tempered steel, polished to a mirror shine. Features two flat rollers, two wire rollers and a pattern roller with two different patterns. Gear ratio is 3:1 and wire rollers from 0.75 to 5mm. Rollers are simple to change for different applications. NOTE: For drawing plain sheet metal use a maximum 5 SWG gauge (3.75mm) and a minimum of 26 SWG gauge (0.45mm). For drawing wire use a maximum 5 SWG gauge and a minimum of 20 SWG gauge.

Stock #	Description	Weight	
M. MIL-280.10	80mm Rolling Mill	58 lbs.	\$325.00



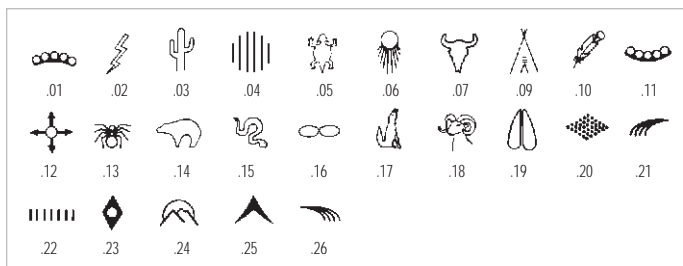

A. PUN-100.xx Southwest – Set of 25 or order individually

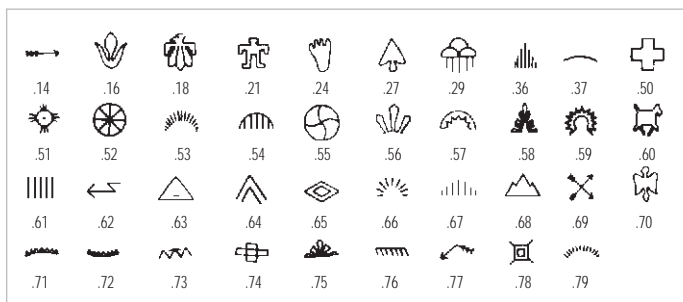

B. PUN-101.xx Indian – Set of 39 or order individually

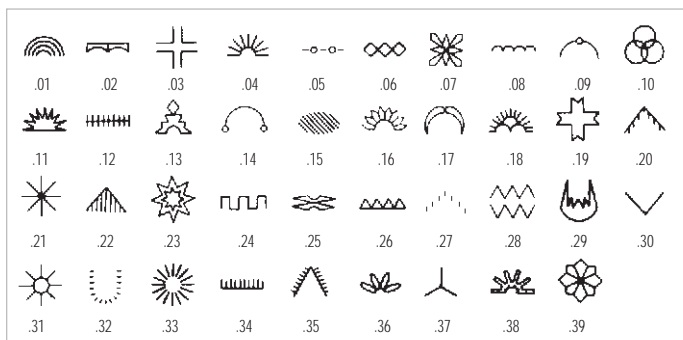

C. PUN-102.xx Traditional – Set of 39 or order individually

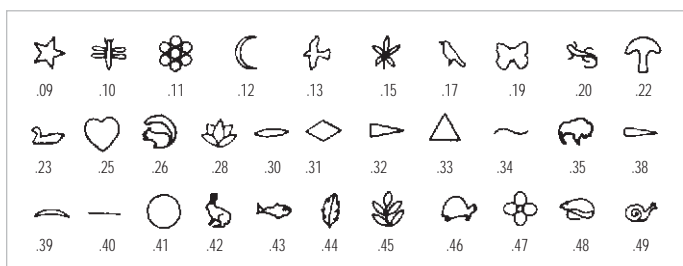

D. PUN-103.xx Contemporary – Set of 32 or order individually

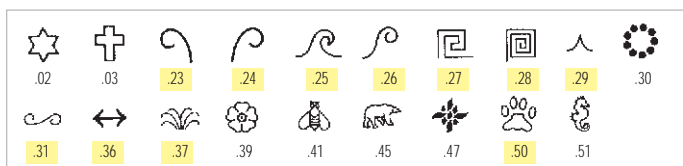

E. PUN-106.xx Millennium – Set of 19 or order individually



DESIGN STAMPS 

Our decorative stamps are made of hardened steel for decorating all types of jewelry items. Figures add value and interest to silver, brass and other metals. Their usage also gives an artistic effect and enables the designer to personalize each piece. All have round shanks and are 3/4" long. Used properly, our stamps will last for years. Made in USA.

Stock #	Description	
A. PUN-100.xx	Southwest Stamps (Use PUN-100 and stamp # from Southwest chart.)	\$7.95
PUN-100.00	Set of 25 (1 each of all Southwest punches shown.)	\$150.00
B. PUN-101.xx	Indian Stamps (Use PUN-101 and stamp # from Indian chart.)	\$7.95
PUN-101.00	Set of 39 (1 each of all Indian punches shown.)	\$234.00
C. PUN-102.xx	Traditional Stamps (Use PUN-102 and stamp # from Traditional chart.)	\$7.95
PUN-102.00	Set of 39 (1 each of all Traditional punches shown.)	\$234.00
D. PUN-103.xx	Contemporary Stamps (Use PUN-103 and stamp # from Contemporary chart.)	\$7.95
PUN-103.00	Set of 32 (1 each of all Contemporary punches shown.)	\$192.00
E. PUN-106.xx	Millennium Stamps (Use PUN-106 and stamp # from Millennium chart.)	\$7.95
PUN-106.00	Set of 19 (1 each of all Millennium punches shown.)	\$48.00
F. PUN-108.xx	Border Stamps (Use PUN-108 and stamp # from Border chart.)	\$7.95
G. PUN-107.xx	Alternative Stamps (Use PUN-106 and stamp # from Alternative chart.)	\$7.95
PUN-107.00	Set of 32 (1 each of all Alternative punches shown.)	\$186.00
H. PUN-109.xx	Whimsical Stamps (Use PUN-109 and stamp # from Whimsical chart.)	\$7.95

See our NEW Whimsical and Border stamps as well as additional styles of Millennium and Alternative Stamps (as noted by yellow highlight).



F. PUN-108.xx Border – Order individually

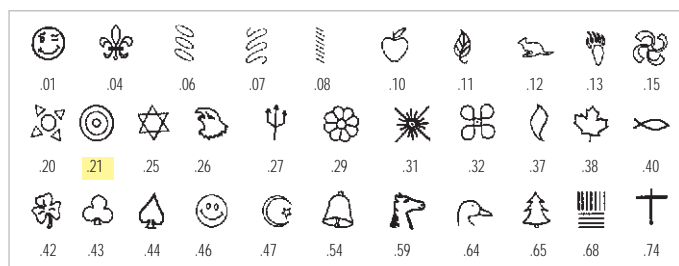

G. PUN-107.xx Alternative – Set of 32 or order individually

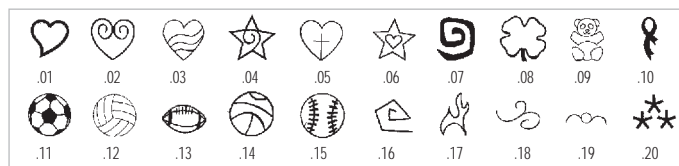

H. PUN-109.xx Whimsical – Order individually



NUMBER AND LETTER PUNCH SETS

Our new alphabet letters includes the “&” sign to make a 27 piece set. A great addition to the letter punches is our number set which contains 9 punches numbered 0 to 9. Made of tempered steel for years of service, these sets are economical, compact, extremely useful, and come to you in a durable plastic box. Punches are 2³/₈" in length and available in three character heights.

Stock #	Description	Size	
PUN-105.75	Number Set – 9pc	1/16" (1.5mm)	\$7.95
PUN-105.85	Letter Set – 27pc	1/16" (1.5mm)	\$11.95
PUN-105.95	Numbers and Letters Set – 36pc	1/16" (1.5mm)	\$16.95
PUN-105.70	Number Set – 9pc	1/8" (3.0mm)	\$7.95
PUN-105.80	Letter Set – 27pc	1/8" (3.0mm)	\$11.95
PUN-105.99	Numbers and Letters Set – 36pc	1/8" (3.0mm)	\$16.95
PUN-105.94	Numbers and Letters Set – 36pc	1/4" (6.0mm)	\$21.25



New!



STAMP STAND – 40 HOLE

Designed specifically to hold our pattern stamps (page 106) it makes storing and searching for the right stamp a much easier task. This practical item is made of hardwood with a generous 40 holes and varnished for good looks and protection.

Stock #	
PUN-140.00	\$8.90



KARAT SPECIALTY STAMPS

Quality USA made stamps. Made on 1/4" round heat treated tool steel. Size of the medium character is approximately 1.0mm in height. Size of the small characters approximately 0.75mm in height. Available in bent or straight.





Style	Straight Stamps			Bent		
	3/4 mm	1mm		3/4 mm	1mm	
10K	PUN-110.03	PUN-110.01	\$8.55	PUN-110.04	PUN-110.02	\$7.95
14K	PUN-114.03	PUN-114.01	\$8.55	PUN-114.04	PUN-114.02	\$7.95
18K	PUN-118.03	PUN-118.01	\$8.55	PUN-118.04	PUN-118.02	\$7.95
24K	PUN-124.03	PUN-124.01	\$8.55	PUN-124.04	PUN-124.02	\$7.95
Sterling	PUN-125.20	PUN-125.00	\$14.95	PUN-125.40	PUN-125.10	\$14.25
Platinum		PUN-126.00	\$14.95		PUN-126.10	\$14.95
925		PUN-127.00	\$8.55		PUN-127.10	\$7.95
PT-900					PUN-128.02	\$7.95
PT-950					PUN-129.02	\$7.95
.999FS	PUN-130.00		\$8.55	PUN-130.10		\$7.95
© (Copyright Symbol)	PUN-131.00		\$8.55	PUN-131.10		\$7.95



Karat Stamps available in bent or straight.

COPPER SHAPES

Prime quality 18 gauge (.04", 1mm) copper which is both oxygen and phosphorous free. Use these shapes to make pendants, charms and other jewelry components. Pair with other metals or use by itself and polish to a high luster. Also may be used for enameling and stamping. Priced and sold in packs of six. **Sizes and styles may vary slightly.**

Circle	Domed Square	Square	Oval	Heart	Star	Crescent Moon	Shield	Triangle
MET-100.01 1/2" \$3.54	MET-111.30 1/2" \$4.46	MET-110.30 1/2" \$3.54	MET-130.30 17/32" x 23/32" \$4.46	MET-130.05 1/2" \$3.54	MET-130.10 7/8" \$4.46	MET-130.12 1" \$3.54	MET-130.16 7/8" x 1 1/4" \$4.46	MET-130.20 7/8" x 1 1/4" \$5.31
MET-100.03 5/8" \$3.54	MET-111.32 3/4" \$4.46	MET-110.32 3/4" \$4.46	MET-130.31 3/4" x 1 3/16" \$4.46					
MET-100.04 3/4" \$4.46	MET-111.34 1" \$6.23	MET-110.34 1" \$6.23	MET-130.32 1" x 1 7/16" \$4.46	MET-140.05 1" \$3.54	MET-140.15 9/16" \$3.54	MET-140.20 5/8" x 1 5/16" \$3.54	MET-140.25 5/8" x 1 5/16" \$4.46	MET-140.30 7/8" x 1 1/4" \$4.46
MET-100.06 1" \$4.46	MET-111.36 1 1/4" \$7.08	MET-110.37 1 1/2" \$7.08						
MET-100.08 1 1/4" \$6.23								
MET-100.10 1 1/2" \$6.23								
MET-100.14 2" \$8.85								



See copper sheet on pg. 238



Use our Ultra Polish Pads to remove any tarnish pg. 174.



METAL HOLE PUNCH PLIERS

Our newly designed hole punch pliers will punch copper or silver as thick as 18 gauge. With ergonomic handles and tempered replaceable pin, these pliers will save you time and money. Now available in two models: 1.25mm or 1.8mm pin diameter. The pliers are made of thick carbon steel and come with an extra replaceable pin. Additional replacement pins available in packs of five. A EURO TOOL EXCLUSIVE. Length 5 $\frac{1}{4}$ " (135mm).

Stock #	Description	
A. PLR-133.50	Metal Hole Punch Pliers – 1.8mm	\$14.95
PLR-133.51	Replacement Pins – 1.8mm, Pk/5	\$6.95
PLR-133.60	Metal Hole Punch Pliers – 1.25mm	\$14.95
PLR-133.61	Replacement Pins – 1.25mm, Pk/5	\$6.95

HOLE-PUNCHING PLIERS

Punch 2mm holes in leather or plastic bands with this handy plier. Great for sizing bands.

Stock #	Length	
B. PLR-138.00	5 $\frac{1}{2}$ " (140mm)	\$10.85

HOLE-PUNCHING PLIERS

Our hole punch pliers are made of the finest steel for long life and ease of use. We've gone high tech with this model, bringing the cost down and the quality up. Unlike most hole punch pliers, this one offers a 1.5mm punch with precise clearance for a clean cut. Gentle return springs and EURO GRIP handles for comfort.

Stock #	Length	
C. PLR-138.05	5 $\frac{3}{4}$ " (145mm)	\$10.95



PARALLEL HOLE PUNCH PLIERS

Developed by EURO TOOL, the Parallel Hole Punch Pliers give the user leverage and assurance that the pin goes straight through the hole every time for a clean shearing action. This guarantees a clean hole without rough edges or burrs in sheet stock up to 18 gauge. Pins are replaceable, so when worn, they can be easily changed for a clean cut every time.

Stock #	Description	Length	
D. PLR-868.00	Parallel Hole Punch Pliers	5 $\frac{1}{2}$ " (140mm)	\$26.95
PLR-868.01	Replacement Pins – 1.5mm, pk/5		\$7.95



LEATHER PUNCH PLIERS

Unique tool, made of stainless steel, features a hardened rotating wheel allowing the user to cut hole sizes from 0.80 to 2.0mm. Great for leather and other soft materials, pliers are box-jointed with a return spring for ease of handling.

Stock #	Length	
E. PLR-139.00	6 $\frac{1}{4}$ " (160mm)	\$24.95

TWO-HOLE METAL PUNCH

Two different hole sizes, 1.60mm (1/16") and 2.30mm (3/32") can be made with our metal punch. Made of tool steel, each punch is tempered for making precision holes in soft metal up to 24 gauge! Screw action makes holes without deforming metal. Can also be used for plastic and other materials. A perfect hole every time!

Stock #	Description	
F. PUN-400.00	Two-Hole Metal Punch	\$24.95
PUN-400.01	Replacement Punch - 1/16"	\$3.20
PUN-400.02	Replacement Punch - 3/32"	\$3.20

TAP-IT PUNCH

Need to punch brass or copper up to 24 gauge? We have the answer in our Tap-It Punch. Features a 1.5mm replaceable tip (two extra tips are included) for just the right size holes. Just place the metal to be punched between the anvil part and the punch tip and give it a light tap with a rawhide or plastic mallet. This method is much faster than using drills or other conventional methods. We recommend hammer HAM-360.05 for a well-made but economical hammer with a nylon head.

Stock #	Height	
G. PUN-410.00	4 $\frac{1}{4}$ "	\$9.95



CENTER PUNCH

This simple center punch is perfect for all non-ferrous metals. Made of high quality tool steel, the point is well tempered for long life. The perfect size and shape for jewelry or other applications.

Stock #	Length	
A. PUN-450.00	4 1/2"	\$19.95



FORMING BLOCK

This block has a variety of grooves including semi-circular and "V" shapes for forming and shaping. It is case hardened and measures 2 1/2" x 2 1/2" x 2". Made in Italy.

Stock #	Size	Weight	
B. DAP-200.00	2 1/2" x 2 1/2" x 2"	3 lbs.	\$119.83



WOOD FORMING BLOCK

Our wood forming block is made of hardwood and hand sanded to a smooth finish. Use this block when working with fine or soft metals and marring could be an issue.

Features include:

- Four round depressions, 1 3/4", 1 7/8", 2 1/8" and 2 1/4" diameters.
- Five "U" channels.
- Two 90° channels.
- Two 45° grooves.

Stock #	Size	Weight	
C. DAP-130.00	2 3/4" x 2 3/4"	6.5 oz.	\$13.95



STEEL AND WOOD BENCH BLOCK

A 1/4" hardened, polished steel block is mounted on quality 3/4" hardwood base. The wood base serves to cushion the blow on impact and transfers less vibration for less stress on the hands. Use the wooden side when a softer surface is needed.

Stock #	Size	Weight	
D. DAP-503.00	3" x 3" x 1"	12 oz.	\$14.95

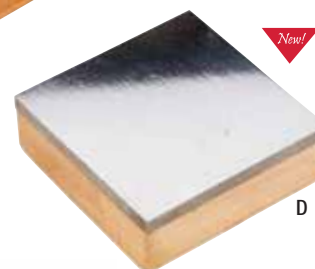

BENCH BLOCK HELPER with STEEL and NYLON BLOCKS

This three piece set includes a thick vulcanized firm rubber base which absorbs shock, plus a solid steel block which is 15/16" (24mm) thick and 3" (75mm) in diameter. The third piece is a sturdy nylon block the same size that fits into the rubber base for lighter, more delicate work. This is a well made set, and allows one to hammer without creating excess noise and vibration at the bench.

Stock #	Weight	
E. DAP-500.30	2.5 lbs.	\$28.95



RUBBER BLOCK

Extremely handy for filing, hammering, and other uses, this rubber block is made of a tough, firm, vulcanized rubber to give the user an excellent surface. It enables one to remove dents and straighten metals without the fear of scratching or distorting, and can be used wet or dry without chance of slipping.

Stock #	Size	
F. BEN-404.00	4" x 4" x 1"	\$5.95

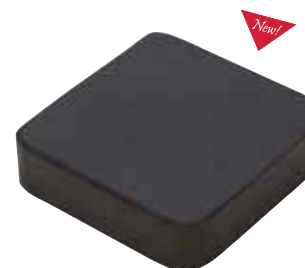

BENCH BLOCKS

Steel blocks, hardened, then carefully drawn for stress relief. You'll notice how finely polished it is when using this block for flattening or chasing.

Stock #	Description	Size	Weight	
G. DAP-525.00	Small Block	2 1/2" x 2 1/2" x 3/4"	1 lb. 4 oz.	\$19.05
H. DAP-525.10	Small Economy Block	2 1/2" x 2 1/2" x 1"	1 lb. 6 oz.	\$10.95
I. DAP-540.00	Large Block	4" x 4" x 3/4"	3 lb. 2 oz.	\$28.15
J. DAP-540.10	Large Economy Block	4" x 4" x 3/4"	3 lb. 2 oz.	\$21.95

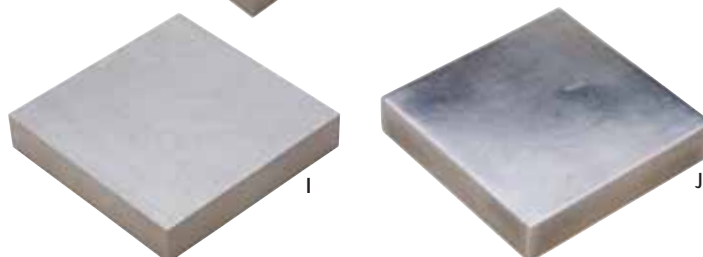
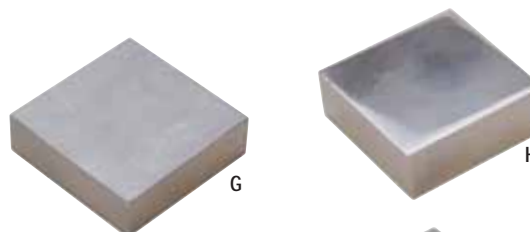

PROFESSIONAL DAPPING TOOLS

The EURO TOOL line of dapping blocks, punches, dies and cutters are made of the finest metals and case hardened used for forming and doming sheet metal for design variations. All have a high polish without pits or flaws.



A



B

*9 half spheres on one side;
5 on the other!*



LARGE, FLAT DAPPING BLOCK

Large block features 27 depressions ranging from 1/16" to 1". The fully-ground alloy steel has a mirror-polished finish and is used to shape metals. The other side is fully ground and can be used as a bench block. Measures 7/8" x 2 1/2" x 5 1/8".

Stock #	Description	Depressions	Weight	
A. DAP-127.00	Lg. Flat Block	27	2 lbs. 9 oz.	\$49.95

FLAT DESIGNER DAPPING BLOCK

This small dapping block offers 22 depressions to allow a variety of shapes to be formed. There are 8 half-cylinders on the sides of the block ranging from 3/16" to 1" and 14 half-spheres on the front and back ranging in size from 1/8" to 1". Overall size 4" x 2 1/2" x 7/8"

Stock #	Description	Depressions	Weight	
B. DAP-114.00	Flat Block	22	2 lbs. 3 oz.	\$69.95

DAPPING DIES

Dapping dies have a polished finish with depressions up to 1 3/4". Used to make beads and shape metals. Available in steel or bronze.

Stock #	Description	Depressions	Size	Weight	
C. DAP-125.00	Steel	21	2 1/2"	4 lbs.	\$29.95
D. DAP-126.00	Bronze	41	2"	2 lbs.	\$35.50

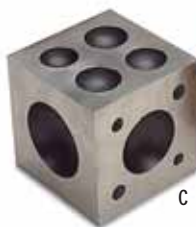

C



D

DAPPING PUNCH SETS

Made of tool steel and case hardened, punches are used with dapping dies and blocks to shape metals.

Stock #	Description	Depressions	Weight	
DAP-714.00	Set of 18	7/64" to 7/16"	3 lbs. 7 oz.	\$39.95
E. DAP-724.00	Set of 24	7/64" to 9/16"	5 lbs. 6 oz.	\$46.95



F



E

12 PIECE PUNCH SET

Set of twelve anodized steel punches with highly polished heads for shaping metals or use with dapping dies. Includes sizes 1/2", 9/16", 19/32", 5/8", 11/16", 23/32", 3/4", 25/32", 13/16", 7/8", 15/16" and 1".

Stock #	Description	Weight	
F. DAP-712.00	Set of 12 w/ Wood Stand	5.25 lbs.	\$42.95

24 PIECE PUNCH SET

Deluxe set of 24 precision machined steel punches on a two-tiered wood stand for easy access and storage. Punches range from 7/16" to 1" and are clearly marked on each punch as well as on the stand.

Stock #	Description	Weight	
G. DAP-713.00	Set of 24 w/ Wood Stand	7.0 lbs.	\$69.95



G

WOOD DAPPING BLOCK with TWO PUNCHES

Two hardwood punches and dapping block for shaping cases or removing dents. Wood will not scratch or mar precious metals. The block features different size depressions on each side and is 2 1/4" (57mm) square.

Stock #	Size	
H. DAP-128.00	2 1/4"	\$6.25



See our complete line of anvils – page 29.



H



DELUXE DAPPING SET

This newly added dapping block has 18 depressions and features 24 punches to dome a great many sizes. Punches range from 3.5 to 25.4mm and are made of case-hardened steel for years of performance. Depressions in the 2" x 2" x 2" block range from 3 to 35mm. This set comes with a hardwood stand to keep it all well organized.

Stock #	Weight	
A. DAP-705.00	8 lbs. 9 oz.	\$69.95



ESSENTIAL DAPPING SET

Includes eight dapping tools with matching block, really all one needs for virtually any job. Cavity sizes are 28, 24, 20, 18, 15, 12, 9 and 6mm with corresponding punches. Block is completely smooth on opposite side for use as a bench block. This set is made of polished steel and comes in a functional wooden stand. Only from EURO TOOL.

Stock #	Weight	
B. DAP-708.00	5 lbs. 4 oz.	\$39.95



SMALL DISC CUTTER

This small cutter features seven sizes ranging from 1/8" to 1/2". Cut perfect circles every time! The holes have been drilled, reamed and then honed to make the finest and cleanest cutter available. The punches are oil-quenched tool steel and drawn for hardness and durability. The bottom base is case-hardened and ground. Cuts metal up to 14 gauge. Measures 2" x 2".

Stock #	Weight	
C. DAP-400.10	1 lb. 10 oz.	\$50.95

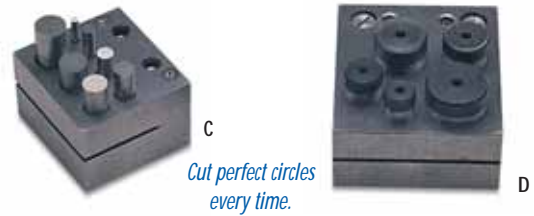

LARGE DISC CUTTER

Large cutter features five sizes ranging from 1/2" to 1". Cut perfect circles every time! The holes have been drilled, reamed and then honed to make the finest and cleanest cutter available. The punches are oil-quenched tool steel and drawn for hardness and durability. The bottom base is case-hardened and ground. Cuts metal up to 14 gauge. Measures 3" x 2 3/4".

Stock #	Weight	
D. DAP-410.10	2 lbs. 12 oz.	\$56.95



DELUXE DISC AND DOMING SET

This set not only cuts flat discs, but also forms and cuts cone or domed shaped discs. It comes with a small disc cutter and 21 punches (7 flat, 7 concave, and 7 convex) all nicely packaged in a wood storage box. Domed discs are formed by using the convex and concave punches with the disc cutter. Cuts seven sizes - 1/4", 5/16", 3/8", 7/16", 1/2", 9/16" and 5/8". A great way to expand your designing options.

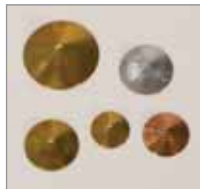

Stock #	Weight	
E. DAP-430.00	3 lbs. 7 oz.	\$64.95

BEZEL BLOCKS and PUNCHES

Polished, hardened steel punch is used for forming tapered bezels. A single punch fits all depressions. The block is case hardened and has highly polished, tapered holes. Made in Italy.

Stock #	Description	Shape	Weight		
F. DAP-349.00	20 Holes, 5 - 20mm	Round, 17°	8 lbs.	●	\$83.43
G. DAP-350.00	20 Holes, 5 - 20mm	Round, 28°	8 lbs.	●	\$86.08
H. DAP-352.00	11 Holes, 4 - 14mm	Square	5 lbs.	■	\$106.92
I. DAP-354.00	11 Holes, 4 - 14mm	Triangular	5 lbs.	▲	\$117.72

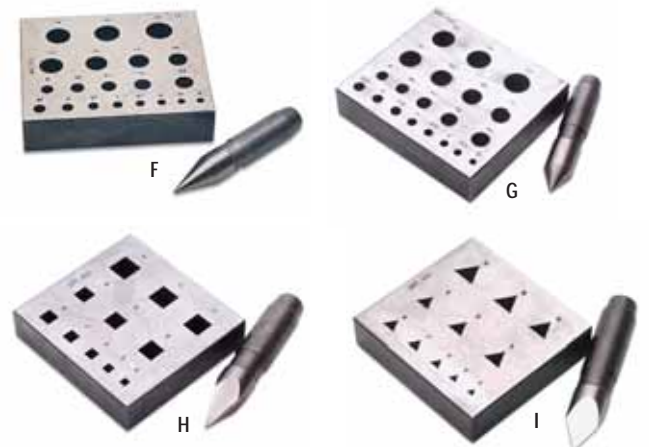



A



B

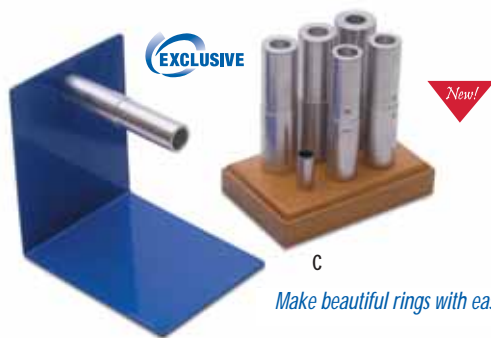

C

Make beautiful rings with ease!

D



E



F



G



H

DOUBLE-SIDED STEPPED MANDREL

Revolving stepped aluminum mandrel on nickel-plated center base. Allows for a full 360° horizontal or vertical rotation. Ideal for wax model building or metal clay work. Smoothly and easily turn your piece as you work. Sizes 4–14 clearly marked on the stepped mandrel. Mandrel can easily be removed from stand for doing handheld detailed work. 6" x 4" base with a 12" mandrel.

Stock #

A. MAN-138.00

\$29.95

STEPPED RING MANDREL ON BASE

Stepped aluminum mandrel securely mounts on a steel base and easily rotates 360°. The smooth round steps allow you to precisely size rings when wax working or using metal clay. Mandrel is clearly marked with sizes 4–13 and can be removed from the stand for handheld use. 13" total length.

Stock #

B. MAN-139.00

\$21.95

MULTIMANDREL™ RING MANDREL SET

This six piece ring mandrel set is ideal for making PMC rings as well as for the traditional wax worker. The steel mandrel stand can be inverted so that you can work on rings from two directions. And the mandrel can be removed from the holder for handheld detail work. The mandrel set consists of six aluminum mandrels covering sizes 4 to 15, allowing you to make PMC rings in sizes 2 to 13. This size range allows for the approximate 2 size shrinkage when making rings from PMC. Additional six piece mandrel set of half sizes covering size 4.5 to 15.5 is available separately. And to keep any of your mandrel sets easily visible and handy to use, we offer a nicely made wood stand accessory.

Stock #

Description

C. MAN-140.10	Multimandrel™ Set with 6 Mandrels (whole sizes 4–15)	\$44.95
MAN-140.25	Set of 6 Mandrels (half sizes 4.5–15.5)	\$35.80
MAN-140.02	Wood Stand	\$8.95

HOOP MANDREL

Our round hoop mandrel is hard chrome plated steel with a highly polished surface and tapers from 3/8" to 2" (10mm to 52mm) for a wide range of rings, earrings, hoops and bracelets, giving it a great variety of uses for goldsmiths, silversmiths, jewelers and bead artists. The weight of solid steel gives it the heft that one needs to more easily work non-ferrous metals.

Stock #

Description

Weight

Length

D. MAN-214.00	Hoop Mandrel	4 lbs.	12"	\$25.75
---------------	--------------	--------	-----	---------

BRACELET MANDRELS

Finely polished bracelet mandrels are excellent quality, American-made. Oval bracelet mandrel tapers from 2 1/2" x 2 3/4" to 1 1/2" x 1 3/4". The round mandrel is offered in four steps. Made in USA.

Stock #

Description

Weight

Length

E. MAN-215.00	Round, Stepped	3 lbs. 4 oz.	8 1/2"	\$42.50
F. MAN-210.00	Oval	3 lbs. 4 oz.	8 1/2"	\$42.50

ECONOMY BRACELET MANDRELS

Smooth steel mandrels designed for bracelets with a taper from 2 1/2" to 1 3/4". Available in round or oval.

Stock #

Description

Weight

Length

G. MAN-216.00	Smooth Round	6 lbs. 7 oz.	15"	\$29.95
MAN-217.00	Smooth Oval	6 lbs. 5 oz.	14"	\$33.95

WOOD BRACELET MANDREL

Our wood bracelet mandrel is perfect for shaping and removing dents or kinks from bangles or bracelets made of softer, non-ferrous metals. Made of hardwood, this mandrel measures 15" long, with a taper from 1 1/2" to 2 1/2" diameter. Value priced, you will get years of service from this beautifully made wood mandrel.

Stock #

Description

Length

H. MAN-220.00	Wood Bracelet Mandrel	15"	\$9.95
---------------	-----------------------	-----	--------

POLISHED NECKLACE MANDREL

To shape necklaces perfectly and easily a neck mandrel is essential. Ours is polished (or brushed) cast iron, and beautifully crafted in Italy. Or choose the value engineered model crafted in India. You can work metals or use the neck mandrel to form wax. Your necklaces will be the perfect length and fit every time.

Stock #	Description	Size	Weight	
A. MAN-225.00	Italian	8 1/2" x 7 3/4" x 7"	6.5 lbs.	\$138.35
B. MAN-235.00	Economy	8 1/2" x 7 3/4" x 7"	6.5 lbs.	\$74.85



Premium quality – shapes necklaces perfectly!



TUBE WRINGER®



You will love the Tube Ringer® – with little effort it will put a beautiful corrugated pattern on metal sheet up to 24 gauge and wire up to 20ga. The 3" rollers will handle sheet stock up to 2.5" wide and leave the metal nice and smooth. Enhance your artistic efforts with this easy to use economical tool. Made in USA

Stock #		
C. HOL-106.00		\$23.95



Jewelry designed by Melissa Cable.



New!

Works with wire too!

STEEL RING MANDREL

Made of hardened tool steel, our ring mandrels combine performance with economy. 11 1/2" long, with a nice gradual taper to accommodate sizes 1 through 15. Available in plain round or round with groove.

Stock #	Description	Length	
D. MAN-255.00	Round Mandrel	11 1/2"	\$22.95
MAN-260.00	Grooved Mandrel	11 1/2"	\$22.95

STEEL RING MANDRELS



American-made mandrels of case-hardened steel are finely polished. Several sizes and styles to fit various requirements of shaping, measuring and enlarging rings.

Stock #	Description	Graduated	Length	
E. MAN-155.00	Round Mandrel	Half Sizes 1 to 16	13 1/2"	\$29.95
F. MAN-160.00	Grooved Mandrel	Half Sizes 1 to 16	13 1/2"	\$28.95
G. MAN-163.00	Flat-sided Mandrel	Half Sizes 1 to 16	13 1/2"	\$28.95
H. MAN-200.00	Large Size Mandrel	Whole Sizes 16 to 24	8 1/4"	\$24.95

BEZEL MANDRELS



Used to form bezels, make chain links and shape decorative ornaments. Made of stainless steel in the U.S. with the highest quality standards. Four styles to choose from to fit a wide variety of applications.

Stock #	Description	Taper	Length	
I. MAN-165.00	Round Bezel	1/2" to 1/8"	11"	\$19.95
J. MAN-166.00	Round Bezel	1/2" to 1/32"	7 3/4"	\$19.95
K. MAN-167.00	Oval Bezel		11"	\$22.35
L. MAN-168.00	Square Bezel		11"	\$24.95

ECONOMY BEZEL MANDREL

Exceptional value round bezel mandrel made of hardened tool steel with a smooth finish and even taper.

Stock #	Description	Taper	Length	
M. MAN-265.00	Round	1/2" to 1/8"	11"	\$9.95

WIRE WRAP RING MANDRELS

A new idea for bead and wire artists. Made of stainless steel with a non-slip PVC handle, this 6" mandrel will give the user consistent size loops time after time. Two sizes available: MAN-105.00 offers five different diameters of 1.50, 2.50, 3.50, 4.50 and 5.0mm giving the user a choice of sizes; MAN-105.10 offers five different diameters of 6.0, 7.0, 8.0, 9.0 and 10.0mm for larger loops and circles. Nicely rounded and extremely smooth so wire will not be scratched. A EURO TOOL original.

Stock #	Description	
N. MAN-105.00	Wire Wrap Ring Mandrel - Small	\$8.95
O. MAN-105.10	Wire Wrap Ring Mandrel - Large	\$9.95
P. MAN-105.99	Set of 2 Wire Wrap Ring Mandrels	\$18.95



EURO TOOL® original



*Cool white
light renders
colors perfectly!*



PORTABLE FOLDING LAMP

The perfect lamp for a multitude of jobs! A reasonably priced portable folding light with a 13 watt daylight bulb. Made of high impact black plastic, with a pure white reflective surface, this light features an adjustment screw to control arm tension. 5300 – 5500K (Kelvin temperature). This is a must for every workspace or bench, especially at this price.

Stock #	Description	
A. LMP-150.00	Folding Lamp	\$24.95
LMP-150.01	Replacement Bulb	\$3.95

5X MAGNIFYING LAMP

This affordable 5X magnifier lamp offers the user a portable solution to viewing anything small. With a 4" lens, see all the details and work with greater ease and better results. Flexible gooseneck design allows the user to adjust the lamp to various heights and positions. Heavy metal base for stability; features non-slip pad. Lamp is a cool-white light that renders colors perfectly and reduces eye fatigue. Easy on-off switch and flip down cover to keep the magnifier free from dust. Excellent for scientific applications, printing, stamp collectors, arts and crafts, detailed painting, hobby and modeling, etc. Uses a 13 watt bulb.

Stock #	Description	
B. LMP-120.00	5X Magnifying Lamp	\$34.95
LMP-120.01	Replacement Bulb	\$5.75



MAGNIFIER LAMP

EURO TOOL can now offer you this swing arm 1.25X magnifier with a circular fluorescent lamp that guarantees the user bright shadowless light with no glare. Lens is 5" and comes with detachable base so that it can easily be attached to bench or table. At this price everyone can afford one.

Stock #	
C. LMP-100.20	\$74.95

GOOSENECK MAGNIFIER

4" diameter round lens on a flexible gooseneck allows you to work with magnification wherever you need it. Using this 3X magnifier keeps your hands free.

Stock #	
D. ELP-560.04	\$11.95

FOLDING MAGNIFIER

Our large-lens (4 1/8" in diameter) 3X folding magnifier is perfect for bead stringing and other fine hand work where magnification is required. Just fold out the unit and you have an indispensable accessory at an exceptional price. Allows the user to have both hands free to work with magnification to make fine work much easier. 6 1/4" tall.

Stock #	
E. ELP-800.03	\$9.45



DIAMOND VIEW™

Perhaps the most functional sales tool to be developed in years for retailers of diamonds and other gemstones. Diamond View™ makes it easy to show off loose or mounted stones to customers. Made of 3/16" Lucite for strength and clarity, light can come through from all directions to illuminate the stone. The lens is a superb quality ten power triplet and features the Stone Mate gem holder. A removable black dot acts in much the same way as a darkfield, enabling the viewer to see the beauty and lucidity of a fine diamond. The gemstone may be rotated 360° to be viewed from all angles. Focusing is achieved by moving the gem holder up or down. This practical approach to viewing gemstones was developed by EURO TOOL and is made in USA. Patent DES 357,694.

Stock #	Description	
A. ELP-300.00	10 X Diamond View	\$49.95
ELP-300.20	20 X Diamond View	\$51.95



DARKFIELD DIAMOND VIEW

The perfect way to determine whether diamonds have been fracture filled. Used with a Maglite® mini flashlight, this fine instrument becomes a portable darkfield, allowing the user to identify the fillings and flaws in diamonds. Featuring a high intensity miniature darkfield and distortion-free 18mm 10X triplet, our Darkfield Diamond View is finished in black oxide for glare free viewing. Comes complete with one Maglite® and is offered in a leatherette pouch.

Stock #	Description	
B. DIA-210.00	Darkfield Diamond View w/ Maglite®	\$68.95
LMP-201.00	Maglite® only	\$15.99



High intensity miniature darkfield and distortion-free 18mm 10X triplet allow user to see flaws in diamonds!

MINI LIGHT MAGNIFIER

This 10X magnifier is state-of-the-art and offers a coated color corrected lens, and high intensity light for examining stones and other fine work such as engraving. Or it can be used as an aid when bead stringing. The high intensity lamp gives the user a maximum amount of light. This unit also features snap out legs, which allow for it to be stationary on a desk top so that it can be used when sorting or examining loose stones. The magnifier requires two AA batteries (not included), and is made of black textured plastic so that it does not glare or show fingerprints. Also included is a handy leatherette protective case. Length 4 3/8".

Stock #	Description	
C. ELP-315.00		\$26.83

10X magnifier and high intensity light make the Mini Light Magnifier great for examining stones!



DETACHABLE LIGHTED MAGNIFIER with MAGLITE®

Our lighted magnifier, offers the best illumination yet for viewing, grading or inspecting stones and other small objects. Attached directly to the mini Maglite® is a 10X or 8X color corrected compound triplet magnifier made of a high impact nylon composite with rubber eyepiece. The magnifier features a diffuser and one-way reflector so that the viewer's eye is directly above the light giving the best possible view. 10X is for diamonds, small gemstones, etc. 8X for flat viewing of stamps and coins. There is nothing else like this on the market today. Patented.

Stock #	Description	
D. DIA-220.00	10X Magnifier w/ Mini Maglite®	\$39.95
DIA-220.10	10X Magnifier Only	\$26.95
DIA-225.00	8X Magnifier w/ Mini Maglite®	\$36.95
DIA-225.10	8X Magnifier Only	\$25.95



Now available in 10x or 8x which is ideal for viewing stamps and coins.

GEMLIGHT GRADING LIGHT

Customers can actually see for themselves the value they are getting! Gemlight is lightweight and compact, but big enough for the professional to grade diamonds and colored stones. It features a verilux and U.V. long wave light, has a deep grading cavity and a 90% cool white background which makes grading diamonds and detecting fluorescence in colored stones a breeze.

Gemlight comes with a protective case, diamond cloth and bulbs. Requires four AA batteries (not included).

Stock #	Description	
E. DIA-338.00		\$89.95

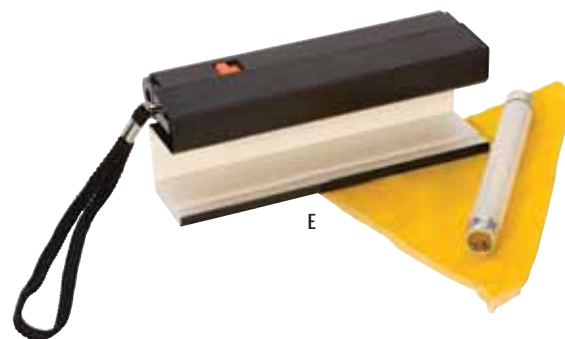

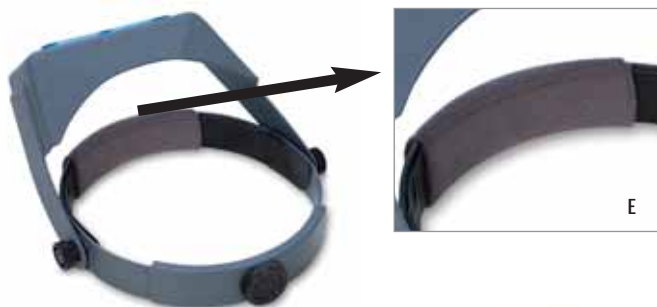
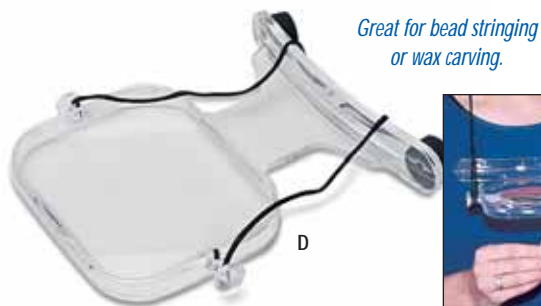

BAUSCH AND LOMB SPECTACLE LOUPES

Convenient method of magnification, these loupes easily attach to the frame of any regular eyeglasses. Adjustable clip fits a variety of temple widths. The lenses, made of optical glass, allow the user to have both hands free and they flip easily out of the way. Magnification is stamped on the clip. Available in single or double lenses.

Stock #	Description	Focus	Power	
A. ELP-871.50	Single Lens	1 1/2"	7X	\$40.50
ELP-872.00	Single Lens	2"	5X	\$38.50
ELP-872.50	Single Lens	2 1/2"	4X	\$37.80
ELP-873.50	Single Lens	3 1/2"	3X	\$36.60
ELP-880.00	Double Lens	1 1/2" to 2 1/2"	4X, 7X	\$47.40
ELP-881.00	Double Lens	2" to 3 1/2"	3X, 5X	\$47.40

HALF-FRAME TELESIGHT MAGNIFIERS

If you do not wear glasses, this is the perfect binocular magnifier for you. Lenses are high quality, prismatic, and the frame is lightweight for maximum comfort. The lenses flip up when not in use. This is an extremely practical method to view articles under magnification.

Stock #	Description	Power	Focal Range	
B. ELP-576.42	#42	1 1/2X	20"	\$39.00
ELP-576.43	#43	1 3/4X	13"	\$39.00
ELP-576.44	#44	2X	10"	\$39.00
ELP-576.45	#45	2 1/4X	8"	\$39.00
ELP-576.46	#46	2 1/2X	6 2/3"	\$39.00
ELP-576.48	#48	3X	5"	\$39.00



MAGNICLIP MAGNIFIER

Lightweight, clip-on magnifiers for use with your glasses offer a hands free magnification when working on precise, detailed work. Easily clips on to any frame and flips up and out of the way when not needed. Rubber pads prevent harm to the surface of the wearer's glasses. MagniClips are available in 5 magnifications and are easily carried in a pocket or purse. Packaged in a protective case.

Stock #	Power	
C. ELP-590.20	2X	\$13.25
ELP-590.25	2.5X	\$13.25
ELP-590.30	3X	\$13.25
ELP-590.40	4X	\$13.25
ELP-590.50	5X	\$13.25

PORTABLE MAGNIFIER

With a wide 4" x 5" viewing area, this portable 2X magnifier leaves both hands comfortably free. Crystal clear, non-distracting frame with stable foot pads and adjustable neck cord holds magnifier steadily in place. Great for bead stringing and wax carving.

Stock #	
D. ELP-560.02	\$13.95

HAPPY HEAD BAND

You'll be happy because perspiration in the eyes and forehead will be a thing of the past. This simple but handy pad is made of soft absorbent cotton. Easily attached with velcro to any headband magnifier, it can be washed and reused many times. Keep several on hand so you're never without because these are inexpensive. Packaged and sold three to a bag.

Stock #	
E. ELP-555.00	\$11.95

EASY EYES HEAD MAGNIFIER

Lightweight magnifier offers four magnifications in one. Flip down loupe, built in main lens and an inner auxiliary lens allow possible magnification ranging from 1.8X to 4.8X. Inner auxiliary lens flips up inside headband when not in use. Comfortable, adjustable Velcro strap.

Stock #	
F. ELP-550.40	\$8.95

QUASAR LED LIGHTING SYSTEM FOR OPTIVISORS

The revolutionary Quasar LED lighting system is the best possible lighting solution available for your magnifying visor. The fixture snaps over the Optivisor lens plate and significantly increases visibility in any environment. Six strategically placed LEDs around the frame allow for unmatched clarity of image while decreasing and virtually eliminating shadows. The lightweight Quasar easily fits onto your magnifying visor and will run continuously for weeks on a single set of batteries. Includes 2 AA batteries.

Stock #
ELP-558.00

\$24.95

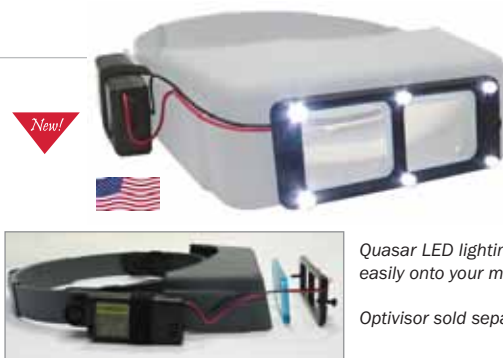

Quasar LED lighting system snaps easily onto your magnifying visor.

Optivisor sold separately.

A. GENUINE OPTIVISORS®

Known worldwide as the best headband magnifier on the market today. Lenses are made of the highest quality optical glass. Six magnifications are available with interchangeable lenses. Headband is leather lined for years of comfort. High impact plastic visor. Special Optiloupe attachment also available for extra power.

Stock #	Description	Magnification	Focal Range	
ELP-502.00	Optivisor #2	1½X	20"	\$39.95
ELP-503.00	Optivisor #3	1¾X	14"	\$39.95
ELP-504.00	Optivisor #4	2X	10"	\$39.95
ELP-505.00	Optivisor #5	2½X	8"	\$39.95
ELP-507.00	Optivisor #7	2¾X	6"	\$41.95
ELP-510.00	Optivisor #10	3½X	4"	\$41.95
ELP-500.01	Optiloupe Attachment (adds 2½X magnification)			\$8.95
ELP-522.00	Replacement Lens #2			\$23.95
ELP-523.00	Replacement Lens #3			\$23.95
ELP-524.00	Replacement Lens #4			\$23.95
ELP-525.00	Replacement Lens #5			\$23.95
ELP-527.00	Replacement Lens #7			\$25.60
ELP-530.00	Replacement Lens #10			\$25.60



A

B. OPTISIGHT

This lightweight headband magnifier is made by the world famous Donegan Optical Company. Offering hands-free magnification, the OptiSight comes in a variety of six colors. Each magnifier comes with three lenses: #3, #4, and #5, with a #7 optional. Great for professionals, hobbyist, etc. Lenses are optical grade acrylic that pop in and out easily. Material is durable and impact resistant.

Stock #	Description	
ELP-540.00	OptiSight with Three Lenses (#3, 4 and 5)	\$25.80
ELP-540.03	Replacement Lens #3 (1¾X)	\$5.15
ELP-540.04	Replacement Lens #4 (2X)	\$5.15
ELP-540.05	Replacement Lens #5 (2½X)	\$5.15
ELP-540.07	Optional Replacement Lens #7 (2¾X)	\$5.15

The OptiSight comes in a variety of six colors with three lenses: #3, #4 and #5.

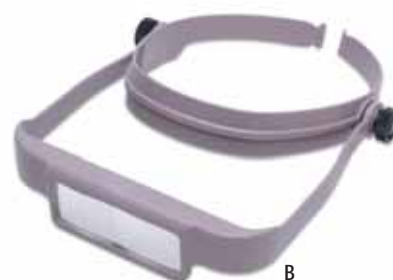

B

C. EURO TOOL BINOCULAR MAGNIFIER

Light as a feather construction makes this magnifier comfortable for daily wear. The band adjusts to fit all head sizes. The lens plates are optical quality acrylic with a scratch resistant coating, allowing the maximum penetration of light. The lenses tilt upward and the unit can be worn over eyeglasses. USA made.

Stock #	Description	Magnification	Focal Range	
ELP-570.03	#3	1.75X	14"	\$14.95
ELP-570.05	#5	2.25X	8"	\$14.95
ELP-570.07	#7	2.75X	6"	\$14.95
ELP-570.13	Replacement Lens #3			\$6.95
ELP-570.15	Replacement Lens #5			\$6.95
ELP-570.17	Replacement Lens #7			\$6.95



C

VERSATILE HEADBAND MAGNIFIER

Our new headband magnifier with light and comfortable and easily adjustable headband offers the most versatility of any headband magnifier made. Comes with four clearly marked lens plates, 1.2X, 1.8X, 2.5X, and 3.5X that easily snap on and off. Center positioned swivel 2.2V/0.75A lamp gives pinpoint lighting in hard-to-see situations (runs on two AAA batteries). This is the ultimate in lighted headband magnifiers. You're guaranteed to like it.

Stock #	Description	
D. ELP-550.00	Versatile Headband Magnifier with Four Lens Plates	\$34.95
ELP-550.10	Four Piece Set of Lenses for ELP-550.00	\$31.95



D



*A Great Gift Idea!
Available in black, gold or silver;
18mm or 21.5mm.*

“DIAMOND CUT” tenX LOUPES

Put some pizzazz in your loupes! Fancy but practical, our new diamond loupes feature a beautiful “Diamond Cut” design. This is not only attractive, but also functional. The Diamond Cut impressions offer the user a much better grip than conventional loupes! The 10X lens is a triplet for good depth of field and minimal glare. Diamond Cut Loupes are offered at very reasonable price points allowing you to easily purchase several and keep a few extra on hand. Available in either 18mm or 21.5mm which offers a larger field of view. Each loupe comes in a protective leather case.

Stock #	Description	Lens Dia.	
A. ELP-745.01	10X Diamond Cut, Black	18mm	\$12.95
B. ELP-745.02	10X Diamond Cut, Gold	18mm	\$13.55
C. ELP-745.03	10X Diamond Cut, Silver	18mm	\$12.95
ELP-747.01	10X Diamond Cut, Black	21.5mm	\$15.95
ELP-747.02	10X Diamond Cut, Gold	21.5mm	\$16.95
ELP-747.03	10X Diamond Cut, Silver	21.5mm	\$15.95



TRIPLLET tenX LOUPES

Available in black, gold or silver, this economical line of loupes offers the user 10X, 18mm triplets at a price that can't be beat. Excellent for department stores. Comes in its own leather case.

Stock #	Description	Lens Dia.	
D. ELP-744.01	10X Triplet, Black	18mm	\$9.85
E. ELP-744.02	10X Triplet, Gold	18mm	\$10.15
F. ELP-744.03	10X Triplet, Silver	18mm	\$9.85

LARGE tenX HEX LOUPES

This 10X “hex” triplet with a 21.5mm lens offers the user a wide field of view and great optics. The case is hexagonal, but the head is actually an elegant twelve faceted design. Supplied in a leather case.

Stock #	Description	Lens Dia.	
G. ELP-746.01	10X Triplet, Black	21.5mm	\$15.65
H. ELP-746.02	10X Triplet, Gold	21.5mm	\$16.70
I. ELP-746.03	10X Triplet, Silver	21.5mm	\$15.65



DOUBLET LOUPES

This range of doublet loupes gives the user an option to spend less, particularly for retail applications. The first three have 12mm lenses, ELP-763.00 is 18mm. Quality for the cost with clear, sharp lenses.

Stock #	Description	Lens Dia.	
J. ELP-760.10	10X Doublet, Chrome/Black	12mm	\$10.35
K. ELP-760.15	15X Doublet, Chrome/Black	12mm	\$10.35
L. ELP-761.10	10X Doublet, Black	12mm	\$10.35
M. ELP-763.00	10X Doublet, Chrome/Black	18mm	\$10.95



10X EXTRA QUALITY HEXAGONAL TRIPLLET LOUPE

The extra-large 21mm viewing field along with the distortion-free, color-corrected, bonded three-piece lens makes this an indispensable tool for the jeweler. The black housing reduces glare. Each high-quality loupe is individually boxed and comes with a protective leather case.

Stock #	Description	Lens Dia.	
N. ELP-755.00	10X Loupe, Chrome/Black	21mm	\$36.95



10X ALUMINUM LOUPE

Inexpensive loupe great for giveaways or promotions. Available in 10X with plastic lens frame and aluminum housing.

Stock #		
O. ELP-742.00		\$1.90

*Great for giveaways or promotions.
Custom logo available.
Call for details!*

LIGHTED LOUPE

Use this 10X lighted loupe in low light environment or when extra light is desired. The ring of six LED lights surround a lens measuring 20.5mm providing a clear, even illumination without casting shadows of harsh reflection. Black non-reflective housing reduces glare and prevents color distortion. See the luster and clarity every time! Battery included.

Stock #	Lens Dia.	Power	
A. ELP-768.01	20.5mm	10X	\$29.95



New!
Great for use
in low light
environment!

**18MM 10X DIAMOND TRIPLET LOUPES**

If you want the very best in professional optics, use our 10X triplet loupes. They are color-corrected with a focal length of one inch and have three-piece bonded lenses for distortion-free viewing. Each comes in its own leather case.

Stock #	Lens Dia.	Power	Color	
B. ELP-750.01	18mm	10X Triplet	Black Matte	\$15.95
C. ELP-750.02	18mm	10X Triplet	Goldtone	\$15.95
D. ELP-750.03	18mm	10X Triplet	Chrome	\$15.95

**ECONOMY DOUBLET LOUPES**

Economical, doublet loupes with chrome finish and 10X lenses offer distortion free viewing and a 1" focal point.

Stock #	Lens Dia.	Power	
E. ELP-765.17	15mm	10X Doublet	\$8.85
F. ELP-765.23	23mm	10X Doublet	\$9.95

**10X ECONOMY TRIPLET HEXAGONAL LOUPES**

Inexpensive, but each is a true triplet for those who prefer the hex shape at an economical price. 20.5mm diameter, three-piece bonded lenses are color-corrected. All come in a protective leather case.

Stock #	Lens Dia.	Power	Color	
G. ELP-757.00	20.5mm	10X Triplet	Chrome/Black	\$19.65
H. ELP-757.01	20.5mm	10X Triplet	Black	\$19.65

**20.5MM 10X DIAMOND TRIPLET LOUPES**

Extra large viewing area with these 10X triplet inspection loupes. Quality three-piece bonded lens is ground for distortion free viewing and extra sharpness. A rubber grip has been added to ELP-759.13 for extra comfort and control. Each comes in a leather case.

Stock #	Lens Dia.	Power	Color	
I. ELP-759.01	20.5mm	10X Triplet	Black Matte	\$21.95
J. ELP-759.13	20.5mm	10X Triplet	Chrome/Black w/Grip	\$22.25

**15X TRIPLET HEXAGONAL LOUPE**

A more powerful 15X loupe offered in chrome and black housing. With a three-piece bonded, color-corrected lens, it has a 20.5mm diameter field of view. Each comes in a leather case.

Stock #	Lens Dia.	Power	Color	
K. ELP-758.00	20.5mm	15X Triplet	Chrome/Black	\$19.95

FANCY COLORED 10X DIAMOND TRIPLET LOUPES

An assortment of vibrantly colored loupes are available in 10X 18mm oval. Our loupes are fun, but they also feature high quality triplet lenses (properly bonded) which allow distortion free viewing. Our edge-to-edge clarity is the finest available. Each come in a leather case and is individually boxed.

Stock #	Lens Dia.	Power	Color	
L. ELP-753.04	18mm	10X Triplet	Brown Tortoise	\$18.95
M. ELP-753.05	18mm	10X Triplet	Blue Lapis	\$18.95
N. ELP-753.06	18mm	10X Triplet	Green Malachite	\$18.95
O. ELP-753.07	18mm	10X Triplet	Black Marble	\$18.95
P. ELP-753.08	18mm	10X Triplet	Pink Marble	\$18.95

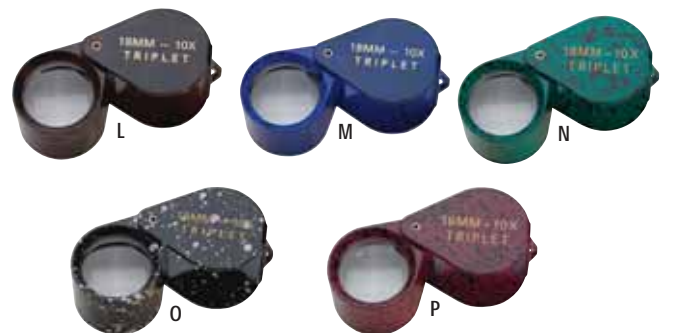

Bausch & Lomb Loupes have been the standard for industrial inspection and watchmaking for decades. Lightweight, easy to wear, they are available in a complete range of styles and powers.

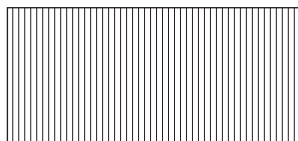

*Magnifier Testing Chart
Use grid for testing edge-to-edge
clarity and sharpness of loupes.*



A



B



C

*We offer a complete line of
watchmaker tools and supplies.
See page 221-237.*



D



E



F

G

H

I

A. BAUSCH & LOMB WATCHMAKER'S LOUPES

Single lens loupes made of optical glass. Their shape allows them to rest comfortably in the eye socket. This has become the standard style of loupe used in the watchmaking industry and is excellent for any application where magnification is needed while keeping both hands free to work.

Stock #	Focus	Power	
ELP-801.00	1"	10X	\$16.83
ELP-801.50	1½"	7X	\$14.28
ELP-802.00	2"	5X	\$14.28
ELP-802.50	2½"	4X	\$13.99

B. BAUSCH & LOMB HASTINGS TRIPLETS

Bausch and Lomb's finest, these triplets are highly corrected. Three optical glass lenses are bonded together to form a compound lens which provides sharp, very distinct magnified images – even under 14 power magnification. The sides of the lenses are coated black to block out glare and the nickel-plated case protects the lens when not in use.

Stock #	Focus	Power	
ELP-829.00	1"	10X	\$51.79
ELP-830.00	¾"	14X	\$58.83

C. BAUSCH & LOMB CODDINGTON MAGNIFIERS

Bausch and Lomb's Coddington Magnifiers stand second only to the Hastings triplets in their magnification quality and performance. Correction is achieved through use of a single thick lens of optical glass with a central groove diaphragm. Provides a sharp, crisp image. The protective swing-away case is nickel-plated.

Stock #	Focus	Power	
ELP-835.00	1"	10X	\$29.95
ELP-836.00	¾"	14X	\$32.96
ELP-837.00	½"	20X	\$36.11

D. PLASTIC EYE LOUPES

Our loupes are high-quality, but inexpensive enough to make them attractive for production use.

Stock #	Focus	Power	
ELP-174.10	1"	10X	\$1.90
ELP-174.20	2"	5X	\$1.90
ELP-174.25	2½"	4X	\$1.70

E. ALUMINUM EYE LOUPES

High-quality, durable loupes are tough but lightweight. Pocket-size loupe has distortion-free lenses and black on the inside of the aluminum housing to eliminate glare.

Stock #	Focus	Power	
ELP-205.10	1"	10X	\$1.90
ELP-205.20	2"	5X	\$1.70
ELP-205.25	2½"	4X	\$1.70

LOUPE CHAINS

It's your choice which you prefer, and either works quite well. Our "snake" chain is nicely designed, and will not catch on clothing. It is durable and attractive, keeping your loupe handy. Nylon cord on the other hand is economical, but efficient. Both are attractive and functional. Each is 39" long.



	Stock #	Description	
F.	ELP-722.02	Snake Loupe Chain – Gold	\$7.95
G.	ELP-722.03	Snake Loupe Chain – Silver	\$7.95
H.	ELP-724.01	Black Nylon Rope Chain – Round	\$2.25
I.	ELP-725.01	Black Nylon Rope Chain – 10mm Flat	\$2.25

OPTISCOPE

The only scope available in this price range which gives you all the essentials. StonePerfect stone holder included for unlimited viewing and sure grip of stones. With its crisp stereoscopic imaging and excellent depth of field, you will be amazed at the optics and mechanics of the OptiScope.

- Crisp stereoscopic imaging and excellent depth of field.
- 10X and 30X magnification.
- Diopter-equipped eye tubes.
- Full 360° head rotation.
- Darkfield illumination.
- Four-position switch for three-way lighting.

Stock #	Description	
MIC-200.00	OptiScope – 10X - 30X	\$520.00
MIC-200.02	Replacement Halogen Bulb	\$12.45
MIC-200.07	Replacement Stereo Eye Cups (pair)	\$21.00



ZOOMSCOPE®

Our exceptionally priced ZoomScope® has a range of 10X–40X magnification. Variable zoom will stay in focus when changing magnifications, and head is mounted on a sturdy cast upright for smooth operation and resistance to vibration.

- Variable halogen illumination from above and below.
- Zoom adjustment made with dual side-mounted zoom control knobs.
- 10X super wide field eyepieces.
- StonePerfect stone holder and darkfield with iris included.

Stock #	Description	
MIC-320.00	ZoomScope® – 10X - 40X	\$695.00



MINI SCOPE

Our 10X and 30X Mini Scope features the best of modern optics in a compact design. Excellent for retail use, this scope offers the user darkfield illumination with a dual light source for viewing the surface and seeing “inside” clear stones. Gem clip and rubber eye shields for better viewing are included.

Stock #	Description	
MIC-510.00	Miniscope – 10X - 30X	\$265.00



STONEPERFECT GEM HOLDER

Our new “StonePerfect” gem holder, is the only unit to meet all requirements of gemologists. The StonePerfect was designed and engineered by EURO TOOL in response to requests over the past several years. We believe that it is absolutely the best holder available, and it is priced far lower than many inferior models.

- Black jaws of non-glare glass-filled nylon have surface tack and serrations to hold all gemstones securely.
- Jaws do not cover the girdle of stones as other gem holders do.
- Jaws turn on-axis so that diamonds and other stones remain in the user's field of view when being rotated.
- StonePerfect Gem Holder includes an adapter so it can be fitted to any microscope, although it will fit 80% of all microscopes right out of the package.
- Comes in a sturdy plastic box for maximum protection.

Stock #		
HOL-510.00		\$39.95



Jaws do not cover the girdle of stones like other gem holders. Jaws turn so that diamonds and other stones remain in the user's field of view when being rotated.



Top rack fits nylon coated beading wire spools as well as pliers and other tools.



**EURO TOOL®
original**
New!

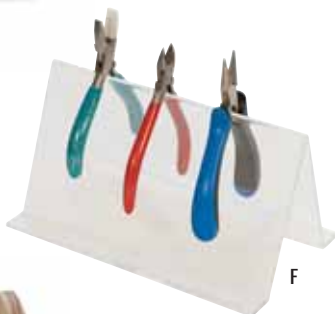

Larger holes fit pliers with ergonomic handles such as Lindstrom RX.

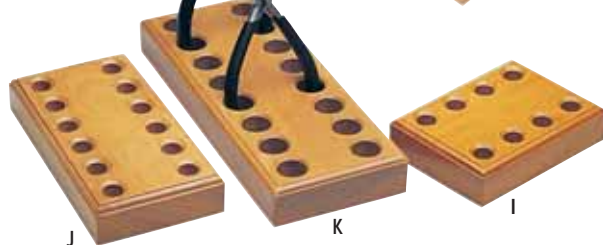

WOOD ORGANIZERS

Beautifully made yet practical wooden plier racks with seven compartments and space below to store various small tools. Model with drawer has even more space to safely hold those small parts so essential to every bench. Nicely dovetailed joints and varnished finish.

Stock #	Description	Size	
A. HOL-307.00	Wood Plier Rack	2 1/2" x 6 1/2" x 7"	\$9.95
B. HOL-309.00	Wood Plier Rack with Drawer	3 3/4" x 6 1/2" x 7 1/2"	\$16.75

ROUND WOOD TOOL STAND

This new hardwood stand, designed by EURO TOOL makes keeping your carvers and tools handy. With a one inch center cavity to store extra carvers or other tools, and holes in the base to store burs or mini brushes, you'll get a lot of good out of this practical stand. Unique in appearance and design, this unit is 2 1/2" tall with a base diameter of 4 1/8" and weighs 6.3 ounces.

Stock #		
C. HOL-360.00		\$13.95

WOOD SAWBLADE HOLDER

Keep sawblades organized on your bench. Fourteen holes to keep sizes separate with a rotating base to keep them easily at your fingertips.

Stock #		
D. HOL-104.00		\$24.95

PLIER and TOOL RACK

Made of clear lucite, our plier rack keeps tools off the bench and easy to find. Rack is over ten inches long and features holes for needle files, burs and other tools. Gives you more bench space and speeds up work because you spend less time looking for the right tool!

Stock #	Size	
E. HOL-305.00	10 1/2" x 3 3/4" x 4"	\$12.95

ACRYLIC PLIER RACK

Clear acrylic plier rack keeps tools accessible, organized, and off the bench. Safely keep plier points upright to protect jaws and edges. Space-saving and practical. Can be custom ordered with name.

Stock #	Size	
F. HOL-304.00	9" x 5" x 4"	\$9.95

WOOD PLIER RACK

This simple wooden rack will hold up to 10 pairs of pliers. Inexpensive and convenient, keeping pliers and cutters handy and off the bench.

Stock #	Size	
G. HOL-306.00	7 1/2" x 3 3/4" x 4 3/4"	\$8.95

LARGE HOLE WOOD PLIER BLOCK

Plier block with large holes to accommodate the Lindstrom RX and EX series as well as our PLR-275.00 UltraErgo and PLR-480.00 2K Ecco Series. Made of first quality hard wood, each rack holds four pair of pliers or cutters, making them handy when needed. Holes are 1 3/16" in diameter

Stock #	Size	
H. HOL-316.04	6 1/2" x 3 1/2" x 1"	\$6.95

WOOD PLIER BLOCKS

Made of hardwood and polished to a high gloss finish, our plier holders make a great bench aid. Holes are beveled for easy in-out handling. Every bench can use them.

Stock #	Description	Size	
I. HOL-315.04	4 Plier Block	4" x 3" x 1"	\$3.65
J. HOL-315.06	6 Plier Block	6" x 3" x 1"	\$5.95
K. HOL-315.08	8 Plier Block	8 1/4" x 3" x 1"	\$6.95

ROUND STACKABLE TRAY

Five round trays stacked over a center locking cylinder for efficient organization. Each 6" round tray has five compartments and is color coded for easy identification. The center cylinder is 6" tall for extra storage of your tools and supplies.

Stock #	Size	
A. TRA-142.05	6" x 6"	\$8.95

ULTIMATE SQUARE STACKER

The Ultimate Square Stackers have five layers with 8 compartments per layer, to hold 40 different items - beads, supplies, notions, jewelry, fly tying components, the list goes on and on! Each layer locks over the center cylinder - that serves well as a tool storage - all held together snugly with twist lock latch. Made from durable polypropylene with positive lock closing snap. Very handy for toting all the items you need for your next project!

Stock #	Size	
B. TRA-145.05	7" x 7" x 6 1/2"	\$14.99

STACKABLE ROUND TRAYS

Space saving convenient trays for storing small parts, beads, stones or other small objects. Each tray has a threaded bottom that securely screws to the tray below it allowing access to any tray at any level. See-thru plastic with two sizes available.

Stock #	Description	Diameter	
C. TRA-105.00	Set of 5	2"	\$2.50
D. TRA-107.00	Set of 7	1 1/4"	\$1.75

STOW 'N' GO ORGANIZER

A perfect organizer for beads, findings, parts and many other small craft items. Each organizer comes complete with six storage containers with tethered lids in clear plastic for easy viewing. Containers are securely held, but easily pulled out with a push of the finger. Can be mounted on a wall, cabinet, or edge of a work table. Great portable storage as it is small enough to fit in a craft bag.

Stock #	Description	
E. TRA-136.06	Stow 'n' Go Organizer	\$6.99

SINGLE CAROUSEL

Single carousel organizer securely holds 12 storage containers with a tray in the middle for miscellaneous tools and supplies. Can be stacked 5 high for maximum storage with minimum space requirements.

Stock #		
F. TRA-138.00		\$7.99

Replacement Storage Containers - sold per pack.

Stock #	Description	Units per pack	
G. TRA-130.00	Standard, 2 1/2" x 7/8"	pk/6	\$2.99
TRA-130.01	Standard Mini, 2 1/2" x 1/2"	pk/12	\$4.49
TRA-130.02	Standard with Tethered Lids	pk/6	\$3.99

DELUXE CAROUSEL ORGANIZER

Great organizer for small items, includes five trays with 60 clear 2 1/2" x 7/8" deep with tethered lids. This deluxe carousel will hold loads of items clearly visible and right at your fingertips! The Deluxe Carousel is mounted on a turntable and when it is used on a table or desk top it only takes a 10" x 10" space to hold over 60 items. Made of tough ABS plastic for years of busy service. Cups are clear, durable polypropylene. Comes fully assembled. Replacement containers sold above.

Stock #		
H. TRA-138.50		\$31.95

SEED BEAD BOTTLE with CORK LID

Save time and patience with our Seed Bead Bottles. User can shake out a few seed beads or bead crimps without having them roll all over. Only a few come out at a time; and these small, 2" clear bottles are an excellent way to store, as well as to display and ship small articles. Each comes with a cork and is made of high quality, clear glass. Bottles are packaged in master boxes of 50 pieces per box.

Stock #		
I. PKG-200.00		\$0.50

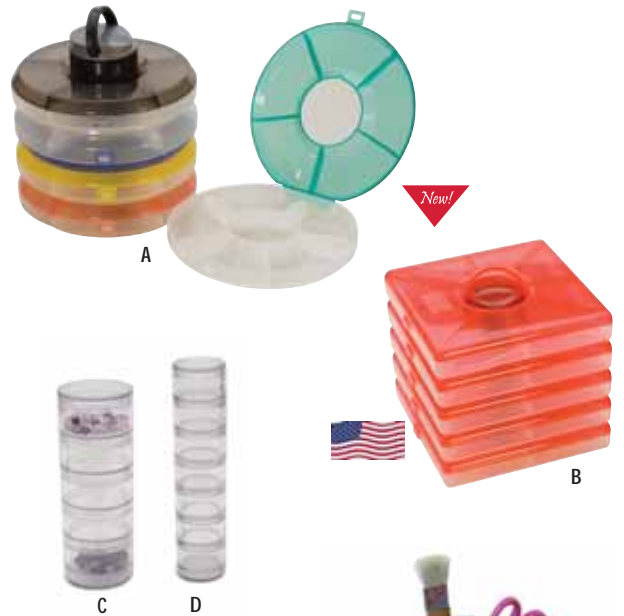
**WOOD BOTTLE STORAGE TRAY**

Our stackable wood storage tray is the best way to store beads in bottles. The soft foam holds 20 of our bottles securely as the holes in the foam are slightly smaller than the diameter of the bottles, so holds the bottles in place.

Stock #	Description	Size	
PKG-210.00	Wood Bottle Tray	7 1/4" x 5 1/4" x 1"	\$10.95
J. PKG-210.20	Tray with 20 Bottles		\$19.95



A



B

C

"Easy Out" feature makes bead retrieval a snap!

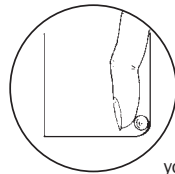

"EASY OUT" COMPARTMENT TRAYS

Trays with "Easy Out" feature are truly easy to use! The front edge of each compartment is rounded so beads, stones or findings can be retrieved easily. Each tray features a slide lid which cannot flip open if dropped. Excellent trays for anything you want to store.

Stock #	Compartments	No. of Overall Size	Compartment Size	
B. PKG-314.00	24	5" x 7 ³ / ₄ " x 1 ¹ / ₈ "	1 ¹ / ₈ " x 1 ³ / ₁₆ " x 5 ⁵ / ₈ "	\$6.65
C. PKG-315.00	18	6 ³ / ₄ " x 10 ¹ / ₂ " x 1 ⁵ / ₈ "	2" x 1 ⁵ / ₈ " x 1 ¹ / ₂ "	\$7.96



D

E

COMPARTMENT TRAYS with SLIDING LIDS

Organize a wide variety of parts and small objects with these handy plastic trays. The slide lid allows for smooth opening and closing operation to keep parts in their place.

Stock #	No. of Compartments	Diameter	
D. PKG-305.00	7	2 ⁷ / ₈ " x 3 ³ / ₈ " x 1 ¹ / ₂ "	\$1.30
E. PKG-310.00	18	3 ³ / ₄ " x 7 ¹ / ₂ " x 3 ¹ / ₄ "	\$5.60



F



G

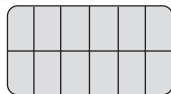

H

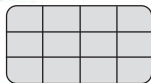

I



CLEAR COMPARTMENT BOXES with HINGED LIDS

Handy trays for beads, clasps, findings, or anything small that you wish to organize. Makes carrying small parts safe and easy.

Stock #	No. of Compartments	Overall Size	Compartment Size	
F. PKG-350.06	6	11" x 6 ³ / ₄ " x 1 ³ / ₄ "	6 ¹ / ₄ " x 1 ³ / ₄ " x 1 ¹ / ₂ "	\$7.75
G. PKG-350.12	12	8 ¹ / ₄ " x 4 ¹ / ₂ " x 1 ³ / ₈ "	2" x 1 ¹ / ₄ " x 1 ¹ / ₄ "	\$5.95
H. PKG-351.12	12	7" x 3 ³ / ₄ " x 1 ¹ / ₄ "	1 ³ / ₄ " x 1 ¹ / ₁₆ " x 1"	\$4.75
I. PKG-352.06	6	4 ⁵ / ₈ " x 3 x 1 ¹ / ₈ "	1 ⁵ / ₁₆ " x 1 ⁷ / ₁₆ " x 1"	\$2.00

ROUND COMPARTMENT TRAYS

Handy trays with compartments have rotating lids which enable the user to open one compartment at a time. Keeps beads, findings, or other small items from spilling or mixing, but within sight. Our extra deep revolving trays allow for bulkier findings and other parts.

Stock #	No. of Compartments	Size	
J. TRA-178.00	20	7 ¹ / ₂ " Dia. x 1 ¹ / ₂ " H	\$6.65
K. TRA-180.00	12	3 ¹ / ₂ " Dia. x 3 ³ / ₈ " H	\$3.25
L. TRA-177.00	10 Extra Deep	6 ¹ / ₈ " Dia. x 1" H	\$8.95
M. TRA-181.00	12 Extra Deep	3 ¹ / ₄ " Dia. x 5 ⁵ / ₈ " H	\$3.45

N. SORTING TRAYS

Trays for sorting diamonds, pearls or gemstones. All trays feature indentations, grooves and a pour spout to make sorting easier.

Stock #	Description	Size	
TRA-120.01	Small Black Tray	4 ¹ / ₂ " x 2 ¹ / ₂ "	\$2.65
TRA-120.02	Small White Tray	4 ¹ / ₂ " x 2 ¹ / ₂ "	\$2.65
TRA-220.01	Large Black Tray	7 ¹ / ₈ " x 3 ³ / ₄ "	\$4.95
TRA-220.02	Large White Tray	7 ¹ / ₈ " x 3 ³ / ₄ "	\$4.95



J

K

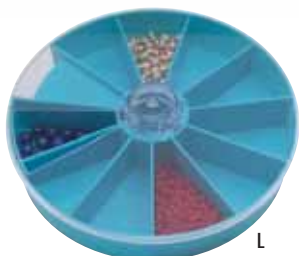

L



M



N

TRANSLUCENT UTILITY TOOL BOX

Easily identify the contents with this see-thru high impact plastic utility tool box. Lightweight yet sturdy with easy open front latch to reveal 2 rows of trays: top tray with adjustable compartments for storage of findings, tools and small parts and a bottom compartment to hold larger items.



Stock #	Size	
A PKG-320.70	13 ¹ / ₄ " x 7 ¹ / ₂ " x 6"	\$15.95

PLASTIC STORAGE CONTAINERS

This is a must have for anyone who is or needs to be organized. Twenty-eight multi-sized stacked screw-together plastic storage containers with lids. This is a great way to see all your small objects, beads and findings in one place. All this nicely kept in a clear container with secure lid.

Stock #	Description	Size	
B. PKG-325.28	28 in 1, with snap lid	10" x 4 ¹ / ₂ " x 1 ³ / ₄ "	\$11.95

Keep small objects in their place. Twenty-four 1¹/₄" round containers with screw on lids are ideal for organizing beads, gems, findings or other small objects. See thru container keeps everything together with a secure lid.

Stock #	Description	Size	
C. PKG-325.24	24 in 1	9" x 6" x 3 ³ / ₄ "	\$11.95

Thirty 1" clear round containers in a handy and convenient clear storage box. Each individual container has a screw on lid to hold findings, beads or other small objects. Lid stays tight for protection.

Stock #	Description	Size	
D. PKG-325.30	30 in 1	6" x 5" x 1"	\$12.45

VINYL BACK CANVAS POUCH

Made of vinyl backed canvas, this pouch holds up to six standard size pliers or cutters. Size is 4" x 8" (10cm x 20cm) when closed, and it features velcro closures to keep everything in order. Perfect for merchandising sets.

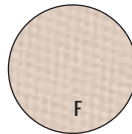

Stock #	Description	Size	
E. BAG-200.06	Blue	4" x 8"	\$5.00
F. BAG-200.06K	Khaki	4" x 8"	\$5.00

ZIP UP TOOL POUCHES

Zip pouches securely hold your pliers and tools. We offer a handy pouch made of sturdy canvas with nylon backing for strength as well as a four piece leatherette plier pouch. As attractive as they are handy, these pouches will hold several pliers or various other tools for storage, sets or on the go!

Stock #	Description	
G. BAG-210.05	Canvas Tool Pouch with Zipper	\$14.95
H. BAG-210.10	4pc Plier Pouch, Black with Zipper	\$9.95

CANVAS TOTE

This lovely blue canvas bag is perfect for beaders, wire wrappers and other artisans. It has one large outer pocket with a unique design. Pockets for holding pliers, cutters, scissors, etc. are on the inside, so if tools fall out they are not lost. This durable bag features canvas with a PVC backing. It measures 11" x 15" (28cm x 38cm) with a 2" (5cm) gusset and holds smaller bead boards and other articles. With two nylon woven handles and zipper for security, it travels anywhere. Our model with zipper on three sides allows for the tote to open flat for easy access.

Stock #	Description	Size	
I. BAG-100.10	Canvas Tote	11" x 15"	\$11.95
BAG-100.15	Canvas Tote - Opens Flat	11" x 15"	\$13.95

TOOL BOXES

Our rugged plastic tool boxes offer multiple compartments and plenty of storage while using minimal space. The set of three comes conveniently nested to save money on freight. With three sizes available, there is no end to the possibilities.

Stock #	Description	Size	
PKG-370.00	Set of Three (small, medium, large)		\$34.95
J. PKG-370.01	Small	10 ¹ / ₂ " x 5" x 3 ³ / ₄ "	\$9.95
K. PKG-370.02	Medium	14" x 7" x 5 ¹ / ₂ "	\$11.95
L. PKG-370.03	Large	18 ¹ / ₂ " x 9" x 8"	\$14.95



Great for kits!

New!



Holds six standard size pliers!



G

H

EXCLUSIVE

Available in two models:
standard opening and
3-sided zipper for tote to
open completely flat.



Put your
company
logo here!

Available individually
or as a set of three!



New!



New!

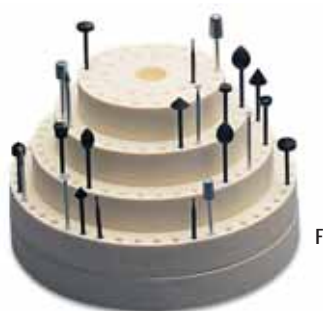
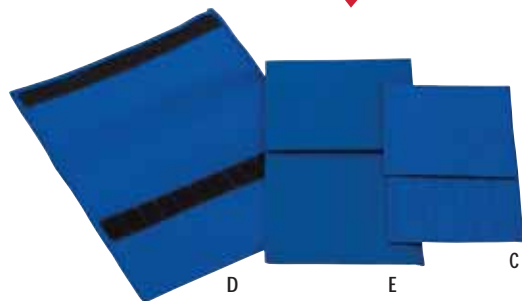

Use several on the bench as project organizers.



Great for screwdrivers or carvers.

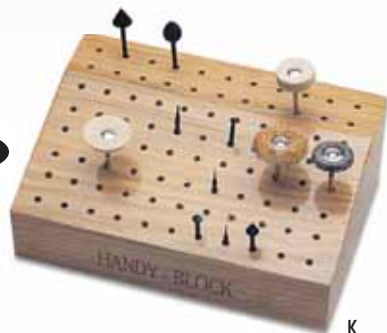

EURO TOOL®
original

LEATHER TWEEZER PROTECTOR

The ideal companion to your quality tweezers. No more ruining expensive tweezers by dropping them and bending the tips. Keep the tips safe and secure by storing them in our leather tweezers pouches. Great for pocket as well as bench.

Stock #	Description	Size	
A. PKG-600.01	Large	6 1/2"	\$1.50
B. PKG-600.02	Small	5"	\$1.45

FILE POUCHES

Finally a pouch made to hold files. This sturdy vinyl backed canvas is made to take punishment so your files do not have to. The Velcro flap secures and protects the files which are contained in individual compartments. Available in 3 sizes, two for needle files and one for hand files.

Stock #	Description	
C. PKG-460.06	6pc Needle File Pouch	\$4.95
D. PKG-460.12	12pc Needle File Pouch	\$5.95
E. PKG-460.04	4pc Hand File Pouch	\$5.95

ROTATING ORGANIZER

This organizer which rotates on steel ball bearings is the best answer to keeping burs, mini brushes, drills, diamond points or anything else which fits into a hand-piece from being lost. Stop wasting time searching for lost tools - this rotating organizer holds up to 156 items with 108 holes sized for 3/32" shank instruments and 48 larger holes to fit 1/8" shank tools. Weight 13 oz.

Stock #	Size	
F. HOL-355.00	3 3/4" x 6"	\$15.95

MAGNETIC BUR HOLDER

This magnetic bur holder keeps burs readily available for the busy jeweler. Made of high impact plastic, with an extra strong magnet. Quick retrieval of burs, drills and other rotary instruments is made easy.

Stock #	Size	
G. HOL-335.00	2 1/4" x 2 1/4"	\$11.95

TOOL STAND with SHARPENER

Polished hardwood stand offers convenient and safe storage for your slim tools such as carvers, screwdrivers, awls, etc. With a built-in sharpening stone and side storage for small parts such as blades, set-screws, this stand holds up to seven tools upright and out of the way with tips and sharp cutting edges safely stored.

Stock #	Size	
H. HOL-356.00	4" x 2 1/2" x 2"	\$13.95

FILE/TOOL ORGANIZER

Made of hardwood, this tray keeps files organized and handy. Well-managed files will stay sharper longer. Tray is slanted for easy viewing.

Stock #	Size	Compartments	
PKG-106.00	9" x 12" x 1 1/2"	6	\$16.45
I. PKG-106.50	9" x 7" x 1 1/2"	5	\$15.25

HANDY BUR BOX

Wood compartment bur box is simply for storing burs. Most jewelers and setters prefer to leave burs in the plastic boxes for easy identification. This box holds small and large packages and has removable dividers which keep boxes upright to easily identify the size and shape.

Stock #	
J. HOL-350.00	\$10.95

HANDY BLOCK

Our HANDY BLOCK is a 4 1/2" x 6" block of cured hardwood with 88 holes for organizing burs, needle files, beadars, mini brushes, etc. Each hole is 1/8" in diameter to accommodate either 1/8" or 3/32" shanks. This block is slanted so the user can see all instruments at a glance. The HANDY BLOCK also features stay-put rubber pads on the bottom to keep it from sliding.

Stock #	Size	
K. HOL-348.00	4 1/2" x 6"	\$14.95

ANTI-TARNISH BAGS AND TABS

Introducing the ultimate anti-tarnish protection for storing and shipping jewelry, silver and other precious metals. The same technology used by NASA, the British Royal Mint and Jewelry manufacturers worldwide is now available through EURO TOOL for your finest jewelry and silver pieces.

- Will not harm any metals or gemstones even when in contact with tab or strip.
- Safe on opals, emeralds and pearls as well.
- The inert material will not release corrosive gases like charcoal based products and is temperature and humidity independent.
- Safe and effective on all non-ferrous metals such as silver, brass, copper and bronze, as well as ferrous metals (iron based).
- Non-toxic, recyclable and environmentally safe.



New!

A. CORROSION PROTECTED POLY ZIP LOCK BAGS

When sealed in one of the clear front Poly Bags, items are protected for up to three years. The copper colored backing turns color as an alert to change bag.

Stock #	Size	Qty.	
PKG-602.30	2 1/2" x 3"	pk/10	\$4.00
PKG-604.40	4" x 4"	pk/10	\$4.75
PKG-604.60	4" x 6"	pk/10	\$5.00
PKG-606.80	6" x 8"	pk/10	\$6.50

B. TABS AND STRIPS

Place your clean dry jewelry in a jewelry box or pouch along with a 1" x 1" tab (covers up to 30 cubic inches) or 2" x 7" strip (up to 420 cubic inches) and the protection will last up to 12 months.

Stock #	Description	Qty.	
PKG-580.10	1" x 1" Tabs	pk/100	\$9.95
PKG-580.20	2" x 7" Strips	pk/20	\$6.95



ENVELOPE HOLDER

Envelope holders keep your repair and storage envelopes organized and ready for quick identification. Made of clear acrylic with three dividers to keep envelopes upright for ease of access. Two sizes available - one for standard repair envelopes and one for wider envelopes.

Stock #	Description	Size	
C. ENV-200.00	Envelope Holder	10 5/8" x 3 3/8" x 3 1/2"	\$13.45
D. ENV-210.00	Wide Envelope Holder	10 7/8" x 4 3/16" x 3 1/2"	\$15.65



REPAIR ENVELOPES

The EURO TOOL job envelope is pleasing to the eye and very economical. The back side lists birthstones and appropriate gifts for each wedding anniversary. There is space at the bottom where the retailer can stamp a company name. Boxed 5,000 per case, 500 to a sub-carton. Measures 3 1/8" x 5 1/2".



Stock #	Qty.	
E. ENV-100.00	Case/5000	\$199.40
ENV-100.05	Box/500	\$21.50

F. PLASTIC BAGS

2 mil, self-locking bags with added strength on each gripper edge; great for storing most anything. Sealing and re-closing feature keeps out moisture and dust while also preventing scratching or tarnishing. Each size is sold in boxes of 1000 (inner packed in bags of 100).



Plain Bags			Bags with White Labeling Block		
Stock #	Size		Stock #	Size	
PKG-620.15	1 1/2" x 2"	\$6.20			
PKG-620.20	2" x 2"	\$6.20	PKG-620.21	2" x 2"	\$6.20
PKG-620.30	2" x 3"	\$7.00	PKG-620.31	2" x 3"	\$7.80
PKG-630.30	3" x 3"	\$9.10			
PKG-630.40	3" x 4"	\$10.85	PKG-630.41	3" x 4"	\$11.35
PKG-630.50	3" x 5"	\$12.60	PKG-630.51	3" x 5"	\$13.65
PKG-640.40	4" x 4"	\$13.85			
PKG-640.60	4" x 6"	\$17.40	PKG-640.61	4" x 6"	\$17.90
PKG-650.70	5" x 7"	\$28.95			
PKG-660.90	6" x 9"	\$35.50			
PKG-680.10	8" x 10"	\$51.50			



G. FOIL GIFT BOXES

Beautiful foil gift boxes available in silver or gold in different sizes. Assortments are a great way to keep a variety on hand or to offer your students for finished pieces.

Gold	Silver	Description	Size	Qty per Case	
PKG-510.00	PKG-530.00	#0	1 7/8" x 1 1/4" x 5/8"	100	\$0.49/ea
PKG-511.00	PKG-531.00	#1	2 1/8" x 1 5/8" x 3/4"	100	\$0.49/ea
PKG-512.00	PKG-532.00	#2	2 5/8" x 1 1/2" x 1"	100	\$0.49/ea
PKG-513.00	PKG-533.00	#3	3 1/4" x 2 1/4" x 1"	100	\$0.69/ea
PKG-514.00	PKG-534.00	#4	3 1/2" x 3 1/2" x 1"	100	\$0.79/ea
PKG-515.00	PKG-535.00	#5	8 1/8" x 1 7/8" x 7/8"	100	\$0.79/ea
PKG-518.00	PKG-538.00	#8	7 1/8" x 5 1/8" x 7/8"	50	\$0.99/ea
PKG-520.00		100pc Gold Assortment			\$26.95/bx
		Contains: #0 (20), #1 (20), #2 (20), #3 (10), #4, (10), #5 (10), #8 (10)			
PKG-540.00		100pc Silver Assortment			\$26.95/bx
		Contains: #0 (20), #1 (20), #2 (20), #3 (10), #4, (10), #5 (10), #8 (10)			



DELUXE MIRRORS

All steel mirrors feature an extremely stable base, with a non-scratch, non-slip pad. The reflectivity of the glass in our mirrors is exceptional. One side is normal; the other side has a 2X magnification. This is a truly high quality series at an excellent price. Individually boxed.

Stock No.	Description	
A. MIR-107.02	7 1/2" Gold	\$19.95
B. MIR-107.03	7 1/2" Chrome	\$17.95

LARGE OVAL RIMLESS MIRROR

This is a beautiful, rimless mirror with beveled edges, standing a total of 18" high, which works perfectly on any countertop. The mirror features a chrome stand and is 10 1/2" wide by 14 3/4" tall. Additionally, the mirror can tilt back a full 45° for viewing of earrings, necklaces, etc. Boxed individually in styrofoam.

Stock #		
C. MIR-110.03		\$45.95



STRING TAGS

The most economical tags available come 1000 pieces per box. Essential for pricing goods at the retail or wholesale store. Actual size: 3/8" x 3/4".

Stock #	Description	Qty.	
D. DIA-400.65	String Tags	1000/bx	\$4.50



E. DISPLAY PINS

Display pins, or jewelry pins as they are sometimes called, are used to hold jewelry - especially chains - onto display pads. 1000 pins per box.

Stock #	Description	Qty.	
DIS-218.00	Gold Tone	1000/bx	\$9.95
DIS-219.00	Stainless Steel	1000/bx	\$10.95



GEM DISPLAY STAND

Suspend your beautiful gemstones for display so that they can be seen. This visually appealing display unit allows stones to "float." Metal base ensures stability. In addition, the salesperson can remove the display so that customers can see the stone up close. Displays are effective sales tools and economical. Show precious gemstones at their best, suspended alone for maximum viewing.

Stock #		
F. HOL-525.00		\$7.95



Use several Gem Display Stands together for an effective store display.

TISSUE CUTTER

With a combination wood and metal frame, this inexpensive cutter is perfect for 7 3/8" gift wrap rolls. Features holes in the base which allow it to be screwed permanently to table or bench top. 2 1/4 lbs.

Stock #		
G. DIA-310.00		\$10.20



JEWELRY SHIELD™

The well-known product that shields sensitive skin from jewelry irritation is now available exclusively from EURO TOOL. Who needs Jewelry Shield? One in four people has an allergy to alloys present in costume and fine jewelry, glasses, watches, even clasps and snaps found on clothing. They suffer itching and skin irritation. Even more people react adversely to metals: their skin turns black, green or suffers from an itchy rash. How does Jewelry Shield work? Brushing transparent Jewelry Shield onto jewelry and metal accessories creates an invisible shield protecting sensitive and allergy-prone skin. Thanks to Jewelry Shield, you can now wear your jewelry without allergic reactions. Jewelry Shield's specially patented formula lasts much longer than any other product or remedy available. One application lasts three months.

Stock #	Description	
H. JWL-180.00	1/2oz. bottle, carded	\$5.99
I. JWL-182.00	12pc display	\$69.95



EXCLUSIVE

Find the Right Plier for the Job!



From quality value pliers to fine European crafted pliers, EURO TOOL strives to meet all levels of requirements and applications. Each series offers unique specifications and standards to meet our customers' expectations. Our extensive line of specialty pliers includes tool for all processes of jewelry manufacturing, beading, watch repair and more.



Ask about our private logo program for select plier lines.

PLIER INDEX

2K Ecco	138
800 Series.....	140
Bead Crimping	149
Bending	143-148
Cutters.....	158-163
Ergonomic	142
EUROnomic 2K German.....	133
Euro Tech	139
Extra-Duty - German.....	134
German Lap-Joint.....	135
Glitter Line™.....	136
Lindstrom.....	129-131
Looping Pliers.....	146
Micro Mini	142
Miniature.....	141
Mirage.....	138
Nylon Jaw.....	145
Relentless - German.....	132, 135
Revere	133
Rosary.....	148
Santa Fe.....	139
Setting.....	152-153
Slimline.....	136
Sonora.....	137
Specialty.....	150-158
Ultra Ergo.....	137
Utility.....	164
Value Series	140
Watchmakers.....	156-157

LINDSTROM®

Recognized by jewelers and craftsmen worldwide, Lindstrom Pliers and Cutters are unsurpassed in quality materials, design and performance. EURO TOOL, Inc. is proud to be the North American distributor of Lindstrom Tools for the jewelry arts industries. See the following pages for the complete line of stocked Lindstrom pliers and cutters. Handy four piece sets are available packaged in a secure zip pouch. Set includes: 7490, 7590, 7893, 8141.

Stock #	Description	
A. PLR-7000	4 pc Lindstrom Set (includes one each 7490, 7590, 7893, 8141)	\$162.20
B. PLR-7000RX	4 pc RX Lindstrom Set (includes one each RX7490, RX7590, RX7893, RX8141)	\$199.95



LINDSTROM®



Recognized by jewelers and craftsmen worldwide, Lindstrom Pliers and Cutters are unsurpassed in quality materials, design and performance. EURO TOOL, Inc. is proud to be the North American distributor of Lindstrom Tools for the jewelry arts industries.

RX CUTTERS AND PLIERS

Lindstrom Rx series represent the very best in cutters and pliers. They exemplify state-of-the-art hand tool design, function and performance.

- Exclusive Micro-Touch™ handles makes possible complete hand control for precision work.
- Exclusive BioSpring® reduces spring tension during work which lessens fatigue and makes work easier and safer. Tension and opening width can be adjusted to suit by moving the end of the spring to the desired opening in the handle.
- Slightly rounded and wider profile of the Rx handle allows for even surface distribution and superior hand contact.



7490RX



7590RX



7890RX



7892RX



7893RX



8147

Stock #	Description	Cut/Jaw	List	Overall Length		Jaw Length		Max. Cutting Capacity			Tip Width	
				MM	Inches	MM	Inches	MM	Inches	Ga.	MM	Inches
PLR-7490RX	Rx7490 Ergonomic Pliers, Flat Nose	Smooth	\$49.50	146.5	5.77"	20.0	.79"				3.2	.12"
PLR-7590RX	Rx7590 Ergonomic Pliers, Round Nose	Very Fine	\$53.50	146.5	5.77"	20.0	.79"				0.5	.02"
PLR-7890RX	Rx7890 Ergonomic Pliers, Chain Nose	Smooth	\$53.50	158.5	6.24"	32.0	1.26"				0.8	.03"
PLR-7892RX	Rx7892 Ergonomic Pliers, Bent Nose	Smooth	\$57.50	155.5	6.12"	29.0	1.14"				0.8	.03"
PLR-7893RX	Rx7893 Ergonomic Pliers, Short Chain Nose	Smooth	\$53.50	146.5	5.77"	20.0	.79"				0.8	.03"
PLR-8140RX	Rx8140 Ergonomic Cutter, Small Oval Head	Micro-Bevel	\$55.50	135.5	5.33"	10.5	.41"	1.25	.05"	16		
PLR-8141RX	Rx8141 Ergonomic Cutter, Small Oval Head	Flush	\$56.50	135.5	5.33"	10.5	.41"	1.25	.05"	16		
PLR-8147RX	Rx8147 Ergonomic Cutter, Small Tapered and Relieved	Flush	\$64.50	135.5	5.33"	10.5	.41"	1.0	.04"	18		
PLR-8150RX	Rx8150 Ergonomic Cutter, Medium Oval Head	Micro-Bevel	\$57.50	138	5.43"	13.0	.51"	1.6	.06"	14		
PLR-8152RX	Rx8152 Ergonomic Cutter, Medium Oval Head	Ultra-Flush	\$69.50	138	5.43"	13.0	.51"	1.25	.05"	16		
PLR-8160RX	Rx8160 Ergonomic Cutter, Large Oval Head	Micro-Bevel	\$61.50	147	5.80"	16.0	.63"	2.0	.08"	12		
PLR-8100RX	Rx Replacement Spring		\$3.95									

Cutting Edge

Using the right edge and knowing the maximum cut for each Lindstrom cutter is vital to not only the life of your plier, but also to the degree of performance you can expect. All cutters are marked with cutting capacity on inside of handle.



Leaves a minimal rise or "pinch" on the cut ends giving you a smaller surface area for soldering. Allows for a very wide cutting range and a variety of uses.



A flush cutting edge will leave a narrower and shorter taper along the "pinch". Flush cutters have finer cutting edges than semi-flush or Micro-Bevel cutters.



The unique Ultra-Flush cutters leave a flat surface on cut ends which virtually eliminates the "pinch" left by most cutters. Has a more limiting cutting range and greater possibility for edge damage due to misuse.

SUPREME CUTTERS AND PLIERS

- Excellent performing pliers with extremely precise jaw alignment.
- Specially forged box-joint with extra long contact surfaces resulting in greater precision and longer life.
- Joint movement is highly stable and smooth which means extra precision even at the extreme tip of the jaws.
- Double-leaf springs with high-impact cushion grips.



7190/7191



7291



7490



7590



7892



7893

Stock #	Description	Cut/Jaw	List	Overall Length		Jaw Length		Max. Cutting Capacity			Tip Width	
				MM	Inches	MM	Inches	MM	Inches	Ga.	MM	Inches
PLR-7190	7190 Supreme Cutter, Tapered Head	Micro-Bevel	\$47.50	109	4.29"	9.0	.35"	1.25	.05"	16		
PLR-7191	7191 Supreme Cutter, Tapered Head	Flush	\$47.50	109	4.29"	9.0	.35"	1.25	.05"	16		
PLR-7291	7291 Supreme Oblique Cutter	Flush	\$56.50	108	4.25"	8.0	.31"	1.25	.05"	16		
PLR-7490	7490 Supreme Pliers, Flat Nose	Smooth	\$40.50	120	4.72"	20.0	.79"				3.2	.13"
PLR-7590	7590 Supreme Pliers, Round Nose	Very Fine	\$43.50	120	4.72"	20.0	.79"				0.5	.02"
PLR-7890	7890 Supreme Pliers, Chain Nose	Smooth	\$40.20	132	5.20"	32.0	1.26"				0.8	.03"
PLR-7892	7892 Supreme Pliers, Bent Nose	Smooth	\$47.50	129	5.08"	29.0	1.14"				0.8	.03"
PLR-7893	7893 Supreme Pliers, Short Chain Nose	Smooth	\$44.50	120	4.72"	20.0	.79"				0.8	.03"
PLR-8100	Double-Leaf Replacement Spring		\$2.05									

80-SERIES CUTTERS

This range of cutters offers unsurpassed cutting capacity covering a wide range of applications.

- Adjustable precision screw joint minimizes friction and maximizes alignment of cutting edges.
- Forged from high-grade steel which provides incredible impact resistance and resiliency.

Precision induction hardened allowing a Rockwell hardness of 63-65 which ranks among the highest of any cutters made.

- Available in traditional oval jaw design, tapered, or tapered and relieved jaw with three cutting edge options: Micro-Bevel, Flush, Ultra-Flush.
- Double-leaf springs with textured surface non-slip handles.



8130



8144/8145



8140/8141/8142



8147



8150/8151/8152



8160/8161

Stock #	Description	Cut/Jaw	List	Overall Length		Jaw Length		Max. Cutting Capacity		
				MM	Inches	MM	Inches	MM	Inches	Ga.
PLR-8130	8130 Extra Small Oval Head Cutter	Micro-Bevel	\$49.50	108	4.25"	8.0	.31"	1.25	.05"	16
PLR-8140	8140 Small Oval Head Cutter	Micro-Bevel	\$47.50	110	4.33"	10.0	.39"	1.25	.05"	16
PLR-8141	8141 Small Oval Head Cutter	Flush	\$48.50	110	4.33"	10.0	.39"	1.25	.05"	16
PLR-8142	8142 Small Oval Head Cutter	Ultra-Flush	\$54.50	110	4.33"	10.0	.39"	1.0	.04"	18
PLR-8144	8144 Small Tapered Head Cutter	Flush	\$49.50	110	4.33"	10.0	.39"	1.25	.05"	16
PLR-8145	8145 Small Tapered Head Cutter	Ultra-Flush	\$54.50	110	4.33"	10.0	.39"	1.0	.04"	18
PLR-8147	8147 Small Tapered and Relieved Cutter	Flush	\$51.50	110	4.33"	10.0	.39"	1.0	.04"	18
PLR-8150	8150 Medium Oval Head Cutter	Micro-Bevel	\$49.50	112.5	4.43"	12.5	.50"	1.6	.06"	14
PLR-8151	8151 Medium Oval Head Cutter	Flush	\$51.50	112.5	4.43"	12.5	.50"	1.6	.06"	14
PLR-8152	8152 Medium Oval Head Cutter	Ultra-Flush	\$58.50	112.5	4.43"	12.5	.50"	1.25	.05"	16
PLR-8160	8160 Large Oval Head Cutter	Micro-Bevel	\$51.50	125	4.92"	16.0	.63"	2.0	.08"	12
PLR-8161	8161 Large Oval Head Cutter	Flush	\$58.50	125	4.92"	16.0	.63"	2.0	.08"	12



Serrated jaws make gripping objects easier!

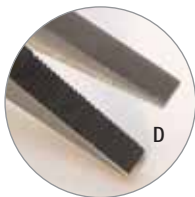

End Cutters are perfect for cutting close to objects.

Oblique Cutters have angled heads so the tip can reach tight places.



RELENTLESS PRECISION 4 1/2" (115MM) PLIERS, GERMAN BOX-JOINT

EURO TOOL'S premium-quality box-joint pliers are the most popular size used by professionals for fine work. Each lightweight German-made plier has been superbly polished. They are made of the highest quality steel and feature blue vinyl-coated handles. Double-leaf springs for smooth and comfortable operation. Cutters in this series have a Rockwell hardness of 58.

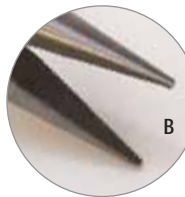

CHAIN NOSE PLIERS

Feature smooth jaws with slightly beveled edges to avoid marring. The nose is tapered to a fine point for bending and most utility work. Also available with serrated jaws.

Stock #	Description	
A. PLR-100.00	Chain Nose	\$20.75
B. PLR-100.02	Chain Nose, Serrated	\$21.95

FLAT NOSE PLIERS

Allows you to grip flat objects and make right angle bends. The smooth or serrated jaws come to a fine even taper.

Stock #	Description	
C. PLR-105.00	Flat Nose	\$20.75
D. PLR-105.02	Flat Nose, Serrated	\$21.95

ROUND NOSE PLIERS

Make loops and round bends with the perfectly round and tapered tips.

Stock #	Description	
E. PLR-110.00	Round Nose	\$20.75

SIDECUTTERS

Fine slim head allows cutters to reach tight spaces.

Stock #	Description	
F. PLR-115.00	Sidecutter, Regular Jaw, Semi-Flush	\$26.90
G. PLR-115.50	Sidecutter, Pointed Jaw, Semi-Flush	\$27.95
H. PLR-130.00	Mini Sidecutter, Pointed Jaw, Semi-Flush	\$30.90
I. PLR-135.00	Mini Sidecutter, Regular Jaw, Semi-Flush	\$29.90

END and OBLIQUE CUTTERS

End cutters are perfect for cutting close to objects. The jaws are at right angles to the handles. Oblique cutters feature an angled head so the tip can reach tight places.

Stock #	Description	
J. PLR-120.00	End Cutter, Semi-Flush	\$29.05
K. PLR-125.00	Oblique Cutter, Flush	\$31.15

BENT CHAIN NOSE

Box-joint, bent chain nose plier with red PVC grips has a multitude of uses in every shop - especially handy for closing prongs. Great quality at an extremely competitive price. Made in Germany.

Stock #	Description	
L. PLR-150.00	Bent Chain Nose	\$22.80

RELENTLESS PRECISION PLIER SET

Four piece Relentless Precision Plier Set contains one each chain, flat, round and regular jaw sidecutter packaged in a leather pouch.

Stock #	Description	
M. PLR-100.98	4 pc Set in Leather Pouch	\$84.95

Ask about our private logo program for select plier lines.



Introducing...

THE REVERE LINE

An exceptional line of quality pliers for the discriminating professional inspired and designed by Alan Revere, a master goldsmith and founder and director of the Revere Academy of Jewelry Arts. Alan's passion for unquestionable quality and the highest standards of workmanship result in a superior line of German-crafted tools made to meet his specifications.



- Handcrafted by expert craftsmen in Germany.
- Made of highest quality carbon tool steel available.
- Hand finished to meet exacting quality standards.
- Extra care and quality control in all phases of production.
- Jaws are hand-finished with beveled corners.
- No plastic handles or springs for precise control and surface contact.

Stock #	Description	
A. PLR-180.00	5" Chain	\$32.95
B. PLR-180.05	5" Flat	\$32.95
C. PLR-180.10	5" Round	\$32.95
D. PLR-180.40	5" Flat/Half Round Bending	\$35.10
E. PLR-180.98	4pc Set w/ Stand	\$137.95

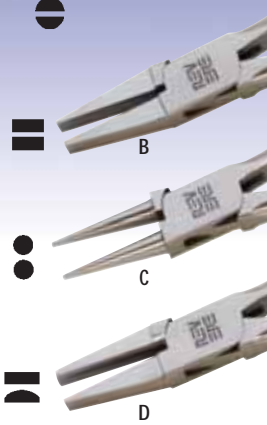

Special tooling is used to create the unique Revere grip.

EUROnomic® 2K GERMAN 43/4" PLIERS

Made in Germany of the finest tool steel and beautifully polished with box-joint construction and double leaf springs, our 43/4" (120mm) line offers the user the latest in ergonomic handles designed for repetitive use. With a handle width of 3/4" (18mm) and a soft non-slip texture, the user is assured of less fatigue and less chance of carpal tunnel syndrome because handle to hand contact is 300% greater than with conventional handles! With attractive black and red handles, pliers can be used for years. Handles are comfortable, but not too cushy to do the job right. So try the latest in comfort and style with EURO TOOL'S EUROnomic® 2K line of pliers.

Stock No.	Description	
F. PLR-380.00	Chain Nose	\$23.50
G. PLR-380.05	Flat Nose	\$23.50
H. PLR-380.10	Round Nose	\$23.50
I. PLR-380.15	Sidescutter – Regular Jaw, Semi-Flush	\$28.45
J. PLR-380.16	Sidescutter – Pointed Jaw, Semi-Flush	\$28.45
K. PLR-380.20	End Cutter – Semi-Flush	\$32.25
L. PLR-380.25	Oblique Cutter – Flush	\$32.35
M. PLR-380.50	Bent Nose	\$25.80

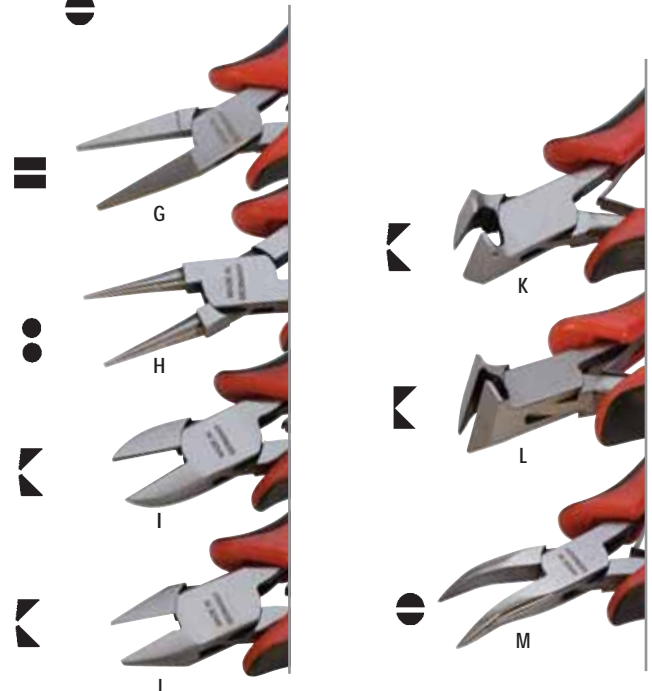
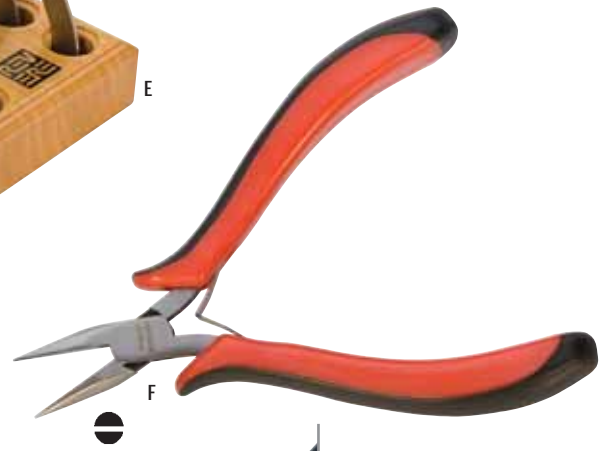

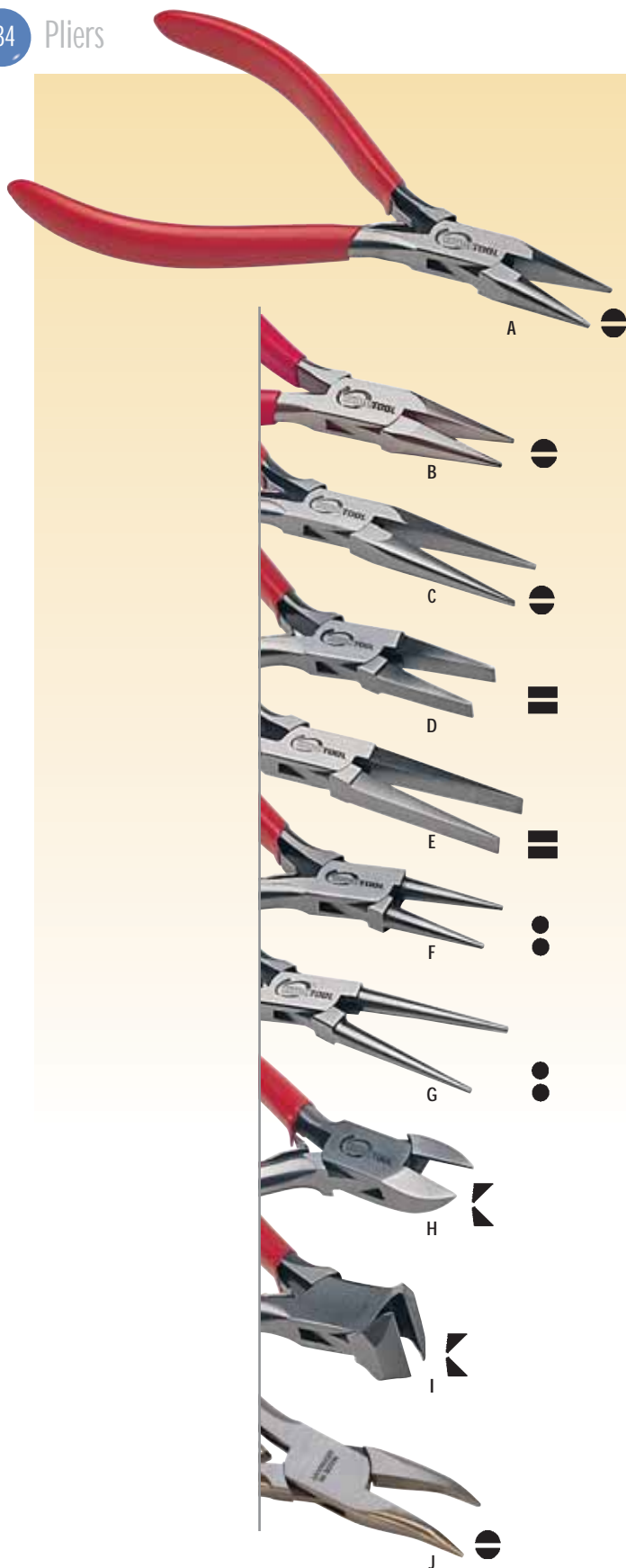

EXTRA-DUTY 5" (125MM) PLIERS – GERMAN BOX-JOINT

EURO TOOL's 5" box-joint pliers feature double-leaf springs and red vinyl grips - some styles also available without springs. Made of the finest European steel available, this series includes a sidecutter durable enough to cut piano wire. Box joints insure lifetime alignment. Made in Germany.

CHAIN NOSE PLIERS

Chain nose pliers feature smooth jaws with slightly beveled edges to avoid marring. Serrated jaws are also available. The nose is tapered to a fine point for bending and most utility work. Extra-long chain nose plier features 1 1/2" jaws for added leverage and special applications.

Stock #	Description	
A. PLR-300.00	Chain Nose	\$21.95
PLR-300.22	Chain Nose, Serrated	\$22.60
B. PLR-300.10	Chain Nose, No Springs	\$21.90
C. PLR-302.00	Extra-Long Chain Nose, 5 1/2" (140mm)	\$22.80
PLR-302.02	Extra-Long Chain Nose, 5 1/2" (140mm), Serrated	\$22.85

FLAT NOSE PLIERS

Allows you to grip flat objects and make right angle bends. The smooth jaws come to a fine even taper. Extra-long version has jaws which are 1 1/2" long for special jobs.

Stock #	Description	
D. PLR-305.00	Flat Nose	\$21.85
PLR-305.22	Flat Nose, Serrated	\$22.80
PLR-305.10	Flat Nose, No Springs	\$21.90
E. PLR-307.00	Extra-Long Flat Nose, 5 1/2" (140mm)	\$22.80

ROUND NOSE PLIERS

Make loops and round bends with the perfectly round and finely tapered tips on this plier. Long round nose has 1 1/2" jaw length.

Stock #	Description	
F. PLR-310.00	Round Nose	\$21.95
PLR-310.10	Round Nose, No Springs	\$21.90
G. PLR-312.00	Extra-Long Round Nose, 5 1/2" (140mm)	\$22.80

SIDECUTTER

A big 5" for heavy work, this sidecutter is tough enough to cut piano wire without nicking. Good leverage and box-joint construction guarantee years of life. Cuts up to 16 gauge.

Stock #	Description	
H. PLR-315.00	Sidecutter, Semi-Flush	\$31.15

END CUTTER

A great cutter for heavy-duty jobs. With well-shaped handles for maximum leverage and hardened cutting jaws, you'll get extended service with minimal effort.

Stock #	Description	
I. PLR-320.00	End Cutter, Semi-Flush	\$38.40

BENT CHAIN NOSE

Box-joint, bent chain nose plier has a multitude of uses in every shop. Great quality at an extremely competitive price. Made in Germany.

Stock #	Description	
J. PLR-350.00	Bent Chain Nose	\$24.60



See details on our Bent Chain Nose Prong Closing Pliers on page 153.

RELENTLESS ERGONOMIC GERMAN PLIERS - 4 1/2"

Relentless Ergonomic German pliers now feature molded handles as pictured, but the handles have been upgraded. They are now made with a superior material which gives them terrific surface tack. Combining superior surface tack with the ergonomic shape gives this line 60% more gripping surface than conventional handles. Made of the finest German steel, with box-joint construction and double-leaf springs, this line will give you years of service. All jaws are precision ground, and cutters have a Rockwell hardness of 60.

Stock #	Description	Length	
A. PLR-100.00E	Chain Nose, Ergonomic	4 1/2" (115mm)	\$22.35
B. PLR-105.00E	Flat Nose, Ergonomic	4 1/2" (115mm)	\$22.35
C. PLR-110.00E	Round Nose, Ergonomic	4 1/2" (115mm)	\$22.35
D. PLR-115.00E	Sidecutter - Regular Jaw, Semi-Flush	4 1/2" (115mm)	\$28.60
E. PLR-115.50E	Sidecutter - Pointed Jaw, Semi-Flush	4 1/2" (115mm)	\$29.75
F. PLR-120.00E	End Cutter, Semi-Flush	4 1/2" (115mm)	\$32.05
G. PLR-125.00E	Oblique Cutter, Flush	4 1/2" (115mm)	\$33.15
H. PLR-130.00E	Mini Sidecutter, Pointed Jaw, Flush	4 1/2" (115mm)	\$32.50
I. PLR-135.00E	Mini Sidecutter, Regular Jaw, Flush	4 1/2" (115mm)	\$30.30



End Cutters are perfect for cutting close to objects.



Oblique Cutters have angled heads so the tip can reach tight places.



Blue molded ergonomic handles give users 60% more gripping surface.

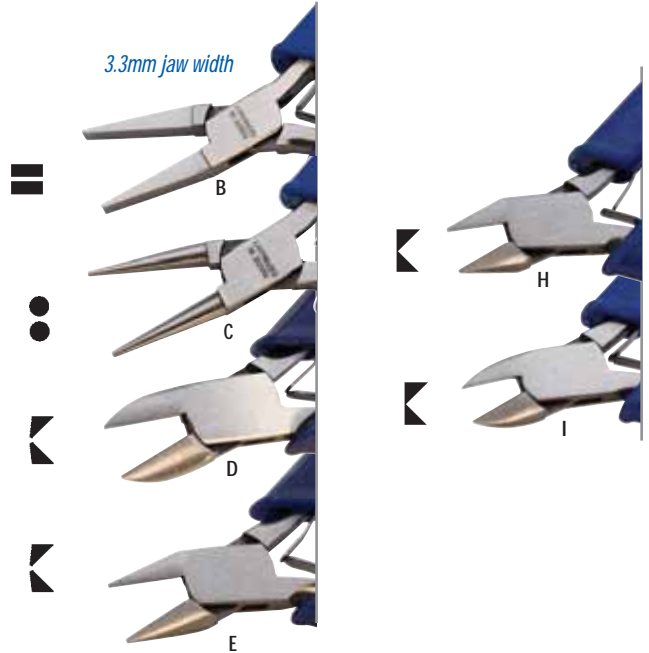

3.3mm jaw width

GERMAN LAP-JOINT 4 1/2" (115MM) PLIERS

This series is made in Germany of the same tempered steel as our box-joint pliers. Because of manufacturing costs, the lap-joint construction offers you high quality pliers at a savings. For normal use, this series will last for years. Features include red cushioned grips with springs and large axle to assure alignment.

Stock #	Description	Length	
J. PLR-400.00	Chain Nose	4 1/2" (115mm)	\$15.20
K. PLR-405.00	Flat Nose	4 1/2" (115mm)	\$15.20
L. PLR-410.00	Round Nose	4 1/2" (115mm)	\$15.20
M. PLR-415.00	Sidecutter, Flush	4 1/2" (115mm)	\$20.55
N. PLR-450.00	Bent Nose	4 1/2" (115mm)	\$21.45
O. PLR-400.99	4 pc Plier Set (Contains 1 each Chain, Flat, Round, and Sidecutter)		\$66.95



3.3mm jaw width

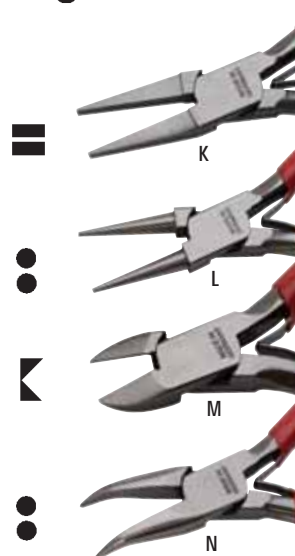

Our German Lap Joint Series offers great value at exceptional quality.



GLITTER LINE™ PLIERS

How about a little pizzazz to get their attention? The new patented Glitter Line™ will beef up your plier sales in a hurry. PVC glitter grips add flair and fun! Just 4½" in length, these stainless steel pliers have double-leaf springs and are precision ground with fine tips. Order individually or in sets of four or a five piece which includes a bent chain nose. Attract attention and extra sales with this new line!

Stock #	Description	Length	
A. PLR-255.00G	Chain	4½" (115mm)	\$7.75
B. PLR-255.05G	Flat	4½" (115mm)	\$7.75
C. PLR-255.10G	Round	4½" (115mm)	\$7.75
D. PLR-255.15G	Sidecutter, Semi-Flush	4½" (115mm)	\$7.95
E. PLR-255.18G	End Cutter	4½" (115mm)	\$10.95
F. PLR-255.30G	Flat Jaw Nylon Plier	4½" (115mm)	\$10.95
G. PLR-255.35G	Single Jaw Nylon Plier	4½" (115mm)	\$10.95
H. PLR-255.50G	Bent Nose	4½" (115mm)	\$7.95
PLR-255.80G	Tungsten Cutter	4½" (115mm)	\$19.95
PLR-255.98G	4 pc Set (Contains 1 each Chain, Flat, Round, and Sidecutter)		\$31.20
PLR-255.98G.01	4 pc Set in Purple Pouch		\$34.95
PLR-255.99G	5 pc Set (Contains 1 each Chain, Flat, Round, Sidecutter and Bent Chain)		\$38.95
I. PLR-255.99G.01	5 pc Set in Purple Pouch		\$42.95

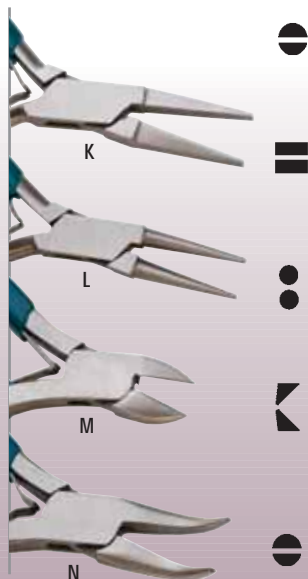
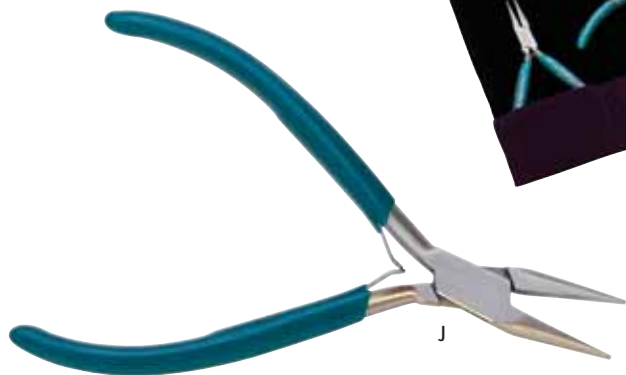
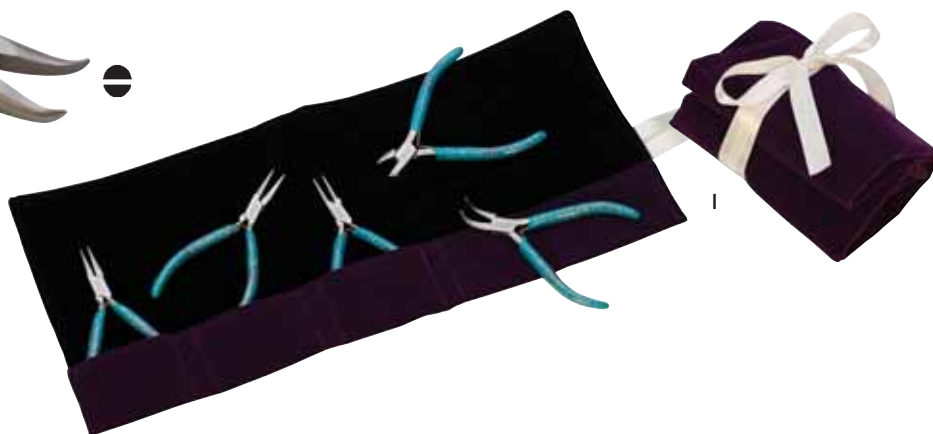
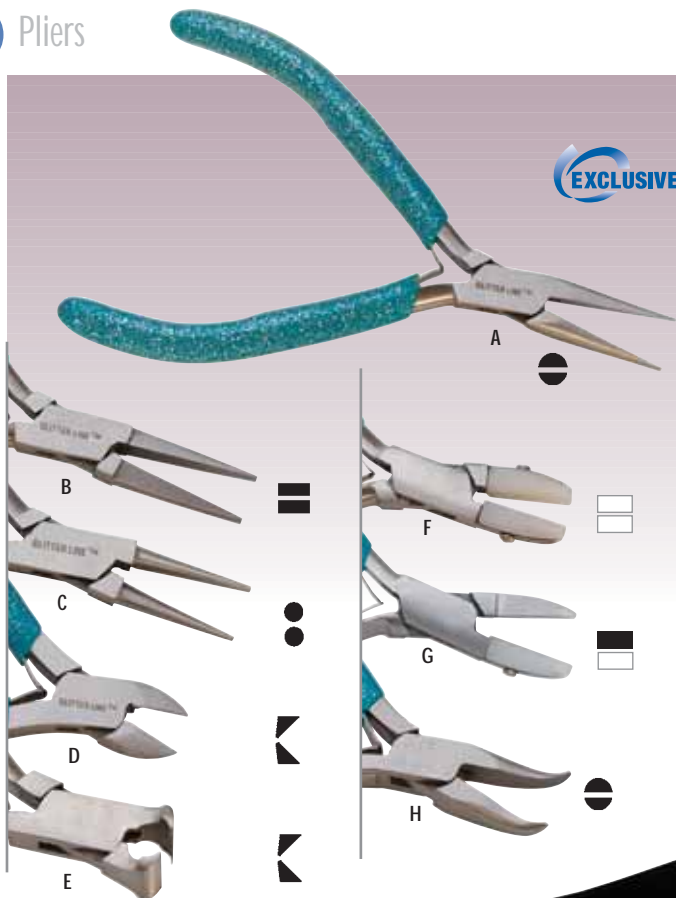

TEAL SLIMLINE PLIERS

Engineered particularly for fine work and smaller hands, this new series is designed specifically for beading and wire wrapping. Available in five different shapes, all are stainless steel, with cushion PVC teal grips and double-leaf springs.

Stock #	Description	Length	
J. PLR-255.00	Chain	4½" (115mm)	\$5.95
K. PLR-255.05	Flat	4½" (115mm)	\$5.95
L. PLR-255.10	Round	4½" (115mm)	\$5.95
M. PLR-255.15	Sidecutter, Semi-Flush	4½" (115mm)	\$5.95
N. PLR-255.50	Bent Nose	4½" (115mm)	\$5.95
O. PLR-255.98	4pc Plier Set (Contains 1 each Chain, Flat, Round, and Sidecutter)		\$22.95
PLR-255.99	5pc Plier Set (Contains 1 each Chain, Flat, Round, Sidecutter and Bent Chain)		\$32.25



ULTRA ERGO PLIERS

A truly ergonomic plier with handles that are slightly larger and straighter than most. This gives the user greater leverage and comfort when using the pliers. Handle width provides greater surface contact which means less fatigue. When closed, the handles are closer together. This is important because hand strength is greater at this point so less force is required. All pliers and cutters feature attractive medium blue grips, double-leaf springs and are made of high grade stainless steel. Jaws on the sidecutters are "relieved" for cutting in tight places.

Stock #	Description	Length	
A. PLR-275.00	Chain	5 3/4" (145mm)	\$10.65
B. PLR-275.05	Flat	5 3/4" (145mm)	\$10.65
C. PLR-275.10	Round	5 3/4" (145mm)	\$10.65
D. PLR-275.15	Sidecutter, Semi-Flush	5 3/4" (145mm)	\$11.95
E. PLR-275.30	Double Nylon Jaw, Flat	5 3/4" (145mm)	\$15.95
F. PLR-275.35	Single Nylon Jaw, Flat	5 3/4" (145mm)	\$15.95
G. PLR-275.46	Round/Flat Nylon Jaw	5 3/4" (145mm)	\$19.95
H. PLR-275.50	Bent Nose	5 3/4" (145mm)	\$11.95
I. PLR-275.80	Tungsten Cutter	5 3/4" (145mm)	\$19.95
J. PLR-275.98	4pc Plier Set in Pouch (Contains 1 each Chain, Flat, Round, and Sidecutter)		\$39.95



SONORA PLIERS

We are proud to present pliers that are user friendly. In fact, our Sonora line offers an all new feel in pliers, with an exclusive textured grip. Grab any of our Sonora pliers and you will experience a touch that makes work easier. These box-jointed, highly polished pliers, are a slender 4 1/2" in length, and made of stainless steel to remain rust-free. Get a grip on our Sonoras and experience the best plier on the market dollar for dollar!

Stock #	Description	Length	
K. PLR-260.00	Chain Nose	4 1/2" (115mm)	\$11.65
L. PLR-260.05	Flat Nose	4 1/2" (115mm)	\$11.65
M. PLR-260.10	Round Nose	4 1/2" (115mm)	\$11.65
N. PLR-260.15	Sidecutter, Semi-Flush	4 1/2" (115mm)	\$12.55
O. PLR-260.50	Bent Chain Nose	4 1/2" (115mm)	\$11.65
P. PLR-260.55	Bent Grooved (Jump Ring)	4 1/2" (115mm)	\$11.95
Q. PLR-260.98	4 pc Plier Set in Pouch (Contains 1 each Chain, Flat, Round, and Sidecutter)		\$45.95

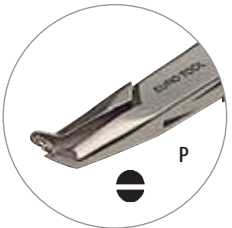

See page 150 for more information on our original Jump Ring Pliers.

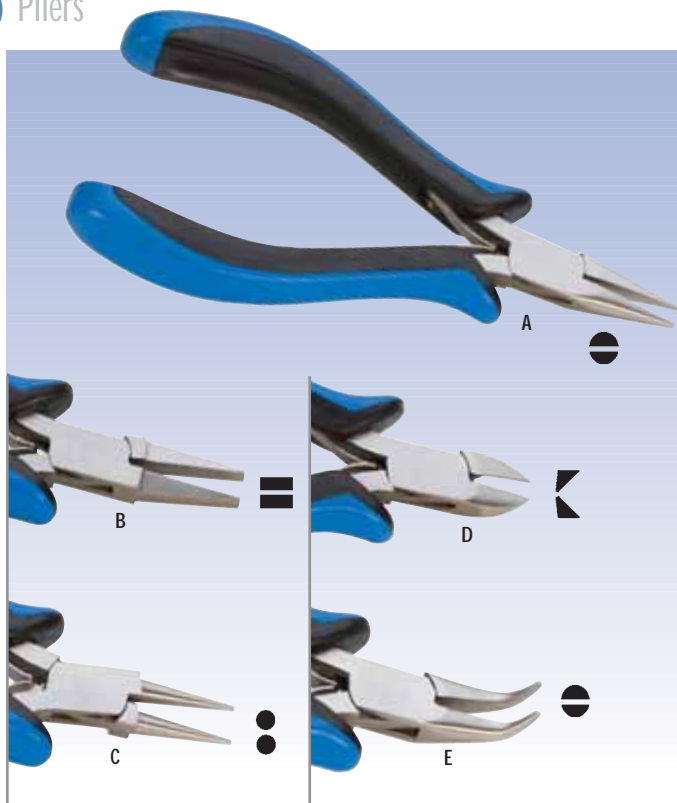

2K ECCO SERIES

Our new line of 2K Ecco pliers are excellent for those who desire quality at a modest price. Made of stainless steel with double-leaf springs, the handles feature a non-slip ergonomic-style grip for excellent comfort and control. Pliers have a brush finish, non-glare surface and box joint for years of service. Length 5" (130mm).

Stock #	Description	Length	
A. PLR-480.00	Chain	5" (130mm)	\$8.95
B. PLR-480.05	Flat	5" (130mm)	\$8.95
C. PLR-480.10	Round	5" (130mm)	\$8.95
D. PLR-480.15	Sidecutter, Semi-flush	5" (130mm)	\$9.95
E. PLR-480.50	Bent Nose	5" (130mm)	\$9.95
F. PLR-480.98	4pc Set (Contains 1 each Chain, Flat, Round, and Sidecutter)		\$36.80
PLR-480.95	4pc Set in Zippered Pouch		\$39.95
PLR-480.99	5pc Set (Contains 1 each Chain, Flat, Round, Sidecutter and Bent Chain)		\$46.75



Ask about our private logo program for select plier lines.

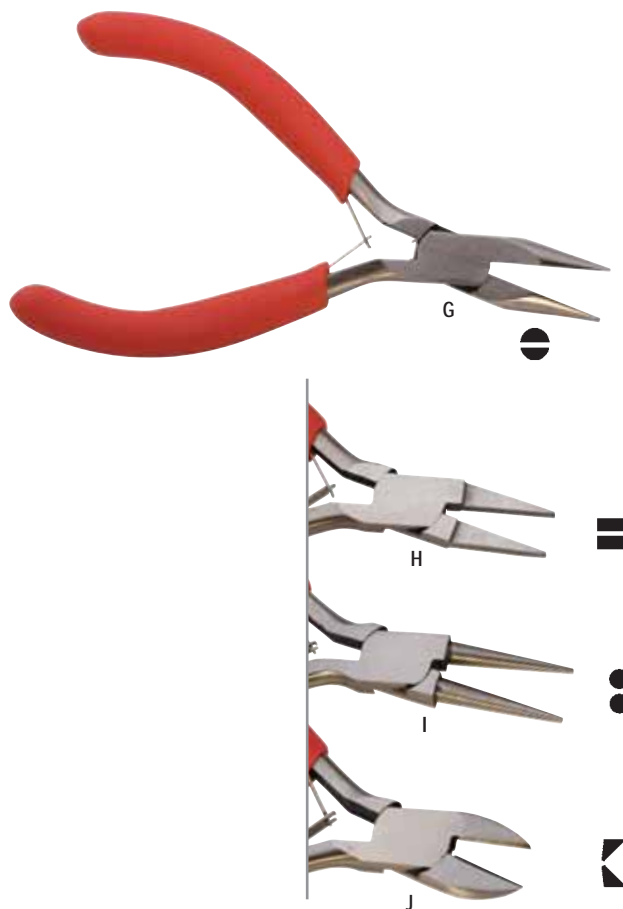

MIRAGE – 4³/₄" LAP-JOINT, ECONOMY SERIES PLIERS

Our line of Mirage pliers may just be the best quality available at this price. Measuring 4³/₄" long and forged of carbon steel, these pliers feature dual-leaf springs and PVC grips. Pliers are lap-jointed with oversized axles to assure long life and smooth action. Cutters are induction-hardened to Rockwell 56. Available individually or in a set.

Stock #	Description	Length	
G. PLR-590.00	Chain Nose	4 ³ / ₄ " (120mm)	\$6.60
H. PLR-590.05	Flat Nose	4 ³ / ₄ " (120mm)	\$6.60
I. PLR-590.10	Round Nose	4 ³ / ₄ " (120mm)	\$6.60
J. PLR-590.15	Sidecutter, Semi-Flush	4 ³ / ₄ " (120mm)	\$7.55
K. PLR-590.98	4 pc Plier Set in Pouch (Contains 1 each Chain, Flat, Round, and Sidecutter)		\$28.05



SANTA FE SERIES

Our Santa Fe Series offers excellent quality at a price just right for the professional who really uses pliers everyday - week after week. With textured PVC handles that give the user a superb grip, double-leaf springs and box-joint construction, this series is an excellent value. The best combination of quality/value/price that we have seen. This series is carbon steel, with induction hardened cutters and with brushed finish.

Stock #	Description	Length	
A. PLR-360.00	Chain Nose	4 ³ / ₄ " (120mm)	\$8.95
B. PLR-360.05	Flat Nose	4 ³ / ₄ " (120mm)	\$8.95
C. PLR-360.10	Round Nose	4 ³ / ₄ " (120mm)	\$8.95
D. PLR-360.15	Sidescutter, Semi-Flush	4 ³ / ₄ " (120mm)	\$9.95
E. PLR-360.20	End Cutter, Semi-Flush	5" (125mm)	\$11.95
F. PLR-360.50	Bent Chain Nose	4 ³ / ₄ " (120mm)	\$8.95
G. PLR-360.98	4 pc Plier Set in Pouch (Contains 1 each Chain, Flat, Round, and Sidescutter)		\$32.95

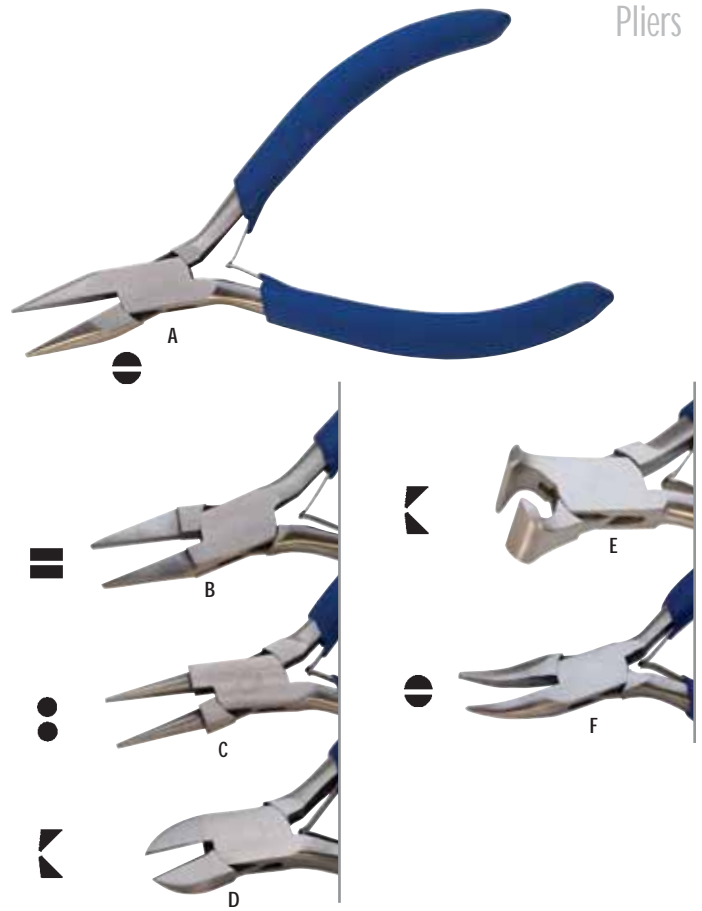

EURO TECH SERIES

User friendly line of 5" pliers with black comfort grips and fine precision points are offered at an exceptional price. Uncompromised quality. Sidescutter includes a gentle coil spring. The newest in comfort technology with black oxidized non-glare finish designed for precision work. Excellent for wire work and beading.

Stock #	Description	Length	
H. PLR-595.00	Chain Nose	5" (125mm)	\$7.95
I. PLR-595.05	Flat Nose	5" (125mm)	\$7.95
J. PLR-595.10	Round Nose	5" (125mm)	\$7.95
K. PLR-595.15	Sidescutter, Flush	5" (125mm)	\$8.45
L. PLR-595.99	4 pc Plier Set in Pouch (Contains 1 each Chain, Flat, Round, and Sidescutter)		\$24.95



Mini chain nose
and flat nose
with serrated
jaws!

Great Value!

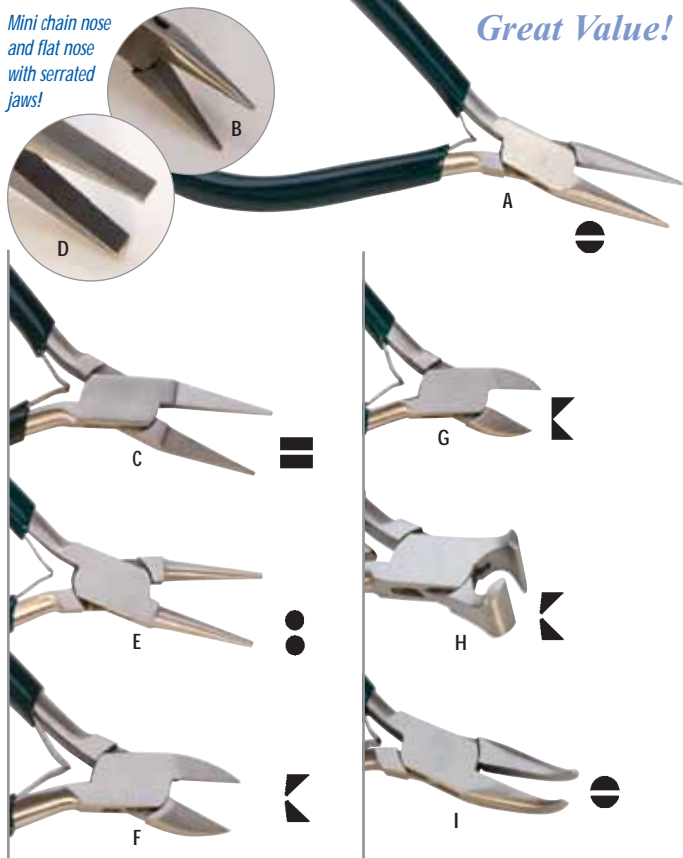

Ask about our private logo
program for select plier lines.

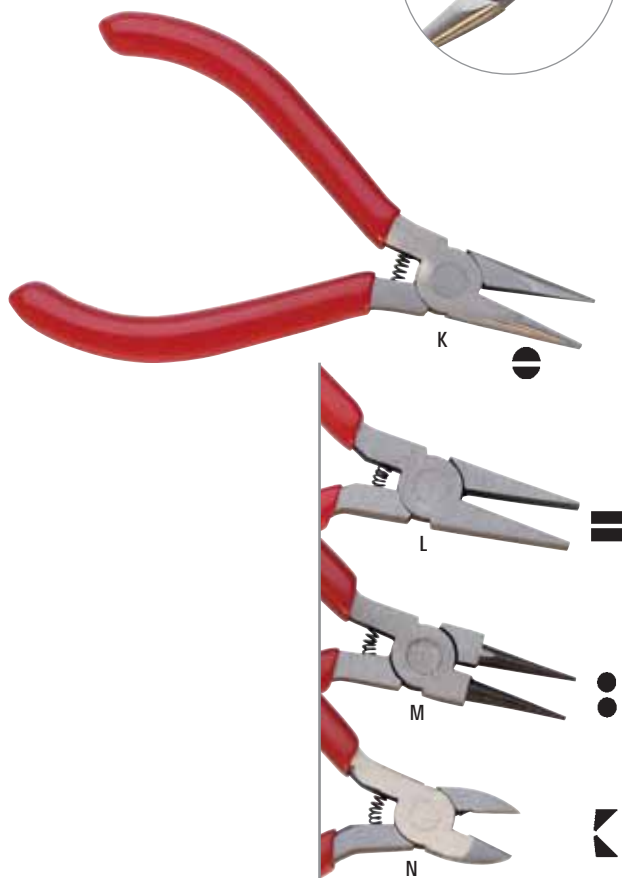

VALUE SERIES PLIERS - BOX-JOINT, GREEN HANDLES

Another EURO TOOL exclusive. Absolutely the best box-joint pliers available at this price or even several dollars more. Made for students, craftspeople or anyone who needs usable pliers and cutters at reasonable prices and consistent quality. Patterned after our German series for comfort and durability, this series features green PVC grips, double-leaf springs, box-joint construction and brush finish in the popular 4 1/2" pattern, as well as 5" sizes. Inexpensive, but the best buy anywhere in this price range.

Stock #	Description	Length	
A. PLR-490.00	Chain Nose	4 1/2" (115mm)	\$5.95
B. PLR-490.22	Mini Chain Nose, Serrated	4 1/4" (110mm)	\$6.25
C. PLR-490.05	Flat Nose	4 1/2" (115mm)	\$5.95
D. PLR-490.25	Flat Nose, Serrated	4 1/2" (115mm)	\$6.25
E. PLR-490.10	Round Nose	4 1/2" (115mm)	\$5.95
F. PLR-490.15	Sidecutter, Semi-Flush	4 1/2" (115mm)	\$6.75
G. PLR-490.35	Mini Sidecutter, Flush	4 1/4" (110mm)	\$6.75
H. PLR-490.20	End Cutter	4 1/2" (115mm)	\$6.75
I. PLR-490.50	Bent Chain Nose	4 1/2" (115mm)	\$6.50
J. PLR-490.98	4 pc Plier Set in Pouch (Contains 1 each Chain, Flat, Round, and Sidecutter)		\$26.10

Stock #	Description	Length	
PLR-495.00	Chain Nose	5" (125mm)	\$6.95
PLR-495.05	Flat Nose	5" (125mm)	\$6.95
PLR-495.10	Round Nose	5" (125mm)	\$6.95
PLR-495.15	Sidecutter, Semi-Flush	5" (125mm)	\$8.95
PLR-495.50	Bent Chain Nose	5" (125mm)	\$7.95
PLR-495.98	4 pc Plier Set in Pouch (Contains 1 each Chain, Flat, Round, and Sidecutter)		\$31.30



800 SERIES PLIERS

We offer a wide variety of pliers, but we never carry a line of pliers or cutters that are not the best quality available. The following series is one which offers the user excellent quality at a great price. All have coil springs, fine points and are made of quality steel. You will be surprised at the level of quality. They are 4 1/2" long and feature comfortable red PVC grips.

Stock #	Description	Length	
K. PLR-800.00	Chain Nose	4 1/2" (115mm)	\$5.95
L. PLR-800.05	Flat Nose	4 1/2" (115mm)	\$5.95
M. PLR-800.10	Round Nose	4 1/2" (115mm)	\$5.95
N. PLR-800.15	Sidecutter, Semi-Flush	4 1/2" (115mm)	\$5.95
O. PLR-804.00	4 pc Plier Set in Pouch (Contains 1 each Chain, Flat, Round, and Sidecutter)		\$22.60



MINIATURE POCKET PLIERS

Finely made from stainless steel, pliers are all 3" (75mm) in length with PVC grips and return spring. Especially handy for bead stringers on the go! Cute to look at, but extremely functional. Working head is constructed from the same size blanks as larger pliers. Three piece handy "Go Anywhere" set includes chain, flat and round nose pliers. Four piece set includes chain, flat, round and sidecutter.

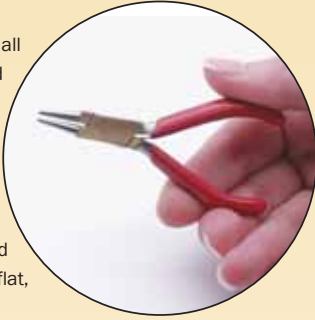

Stock #	Description	Length	
A. PLR-430.00	Mini Chain Nose	3" (75mm)	\$3.65
B. PLR-430.05	Mini Flat Nose	3" (75mm)	\$3.65
C. PLR-430.10	Mini Round Nose	3" (75mm)	\$3.65
D. PLR-430.15	Mini Sidecutter	3" (75mm)	\$3.95
E. PLR-430.18	Mini Rosary	3 1/2" (90mm)	\$3.95
F. PLR-430.30	Mini Flat Nose w/ Nylon Jaw	3" (75mm)	\$4.95
G. PLR-430.90	3pc Set in Pouch, (Contains 1 each Chain, Flat, Round)		\$10.95
PLR-430.20	3pc Mini Plier Set, Carded (Contains 1 each Chain, Flat, Round)		\$9.95
PLR-430.50	4pc Mini Plier Set, Carded (Contains 1 each Chain, Flat, Round, and Sidecutter)		\$12.75

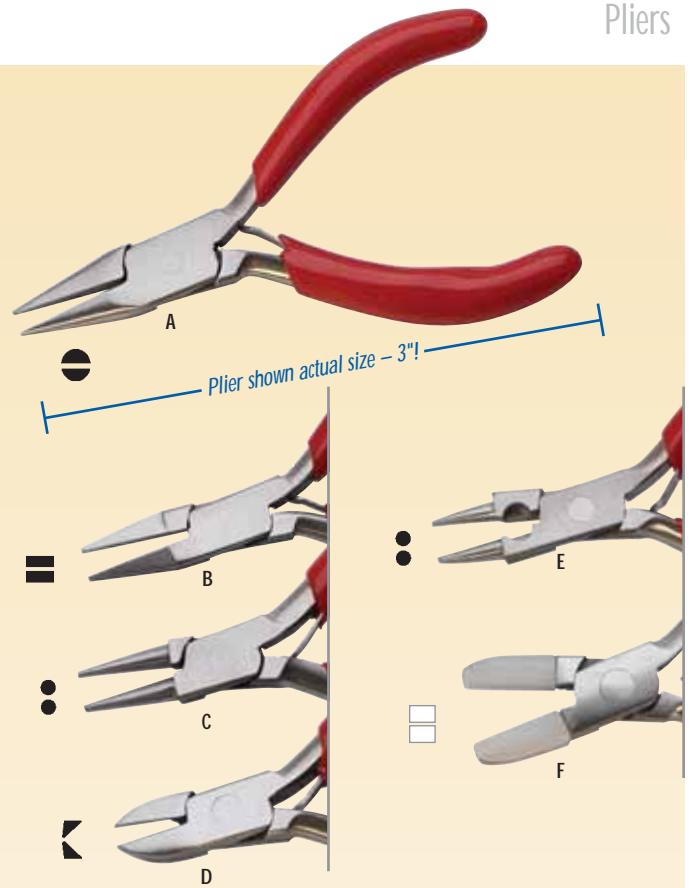

MINI PLIERS

This line of economical mini pliers features very precise tips for wire wrappers and bead stringers in particular. The PLR-250.35 has a miniature flat/round jaw for precise coiling. All have PVC comfort grips and rugged box-joint construction.

Stock #	Description	Length	
H. PLR-250.00	Chain Nose	4 1/2" (115mm)	\$7.95
I. PLR-250.05	Flat Nose	4 1/2" (115mm)	\$7.95
J. PLR-250.10	Round Nose	4 1/2" (115mm)	\$7.95
K. PLR-250.35	Flat/Round Nose	4 1/2" (115mm)	\$7.95

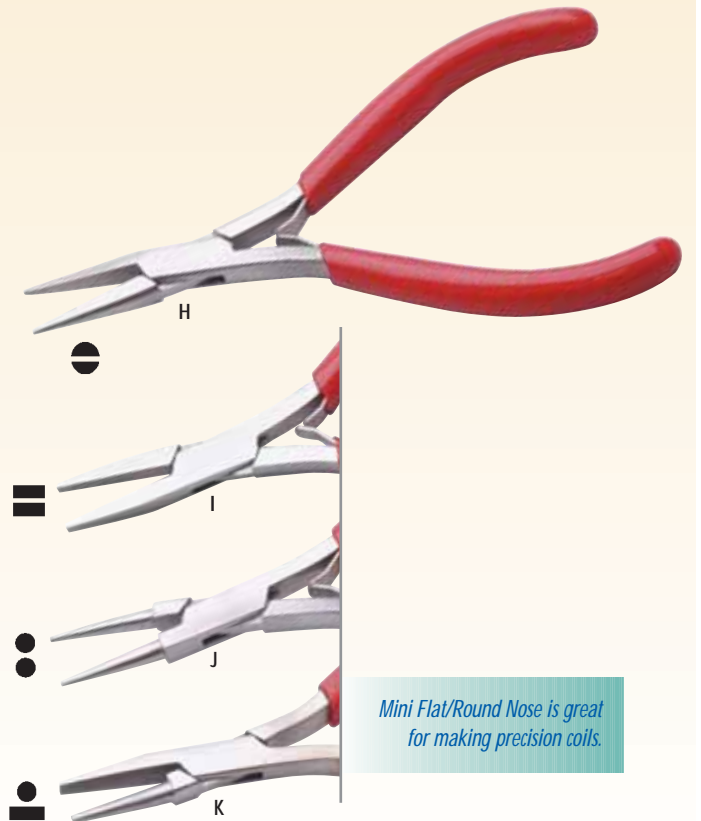

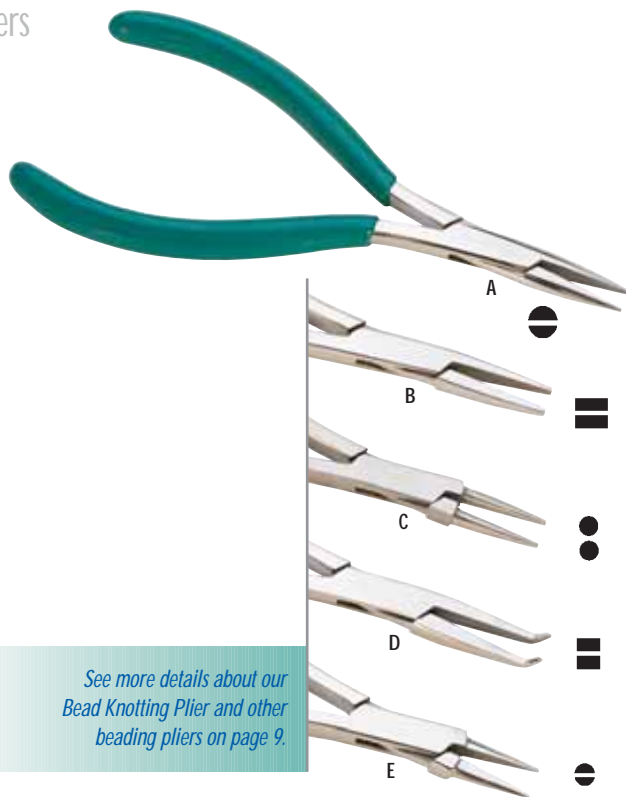

See more details about our Bead Knotting Plier and other beading pliers on page 9.

MICRO MINI PLIERS

Made originally for the electronics trade, this series of pliers gives the user precise surgeon-like control. Slim (only 3/16" x 1/8" at hinge pin) and ultra light, Micro Mini pliers are outstanding for delicate jobs and are especially popular with the beading industry. All are 5" in length. Box-joint construction, stainless steel and curved comfort-designed cushioned handles give the Micro Mini pliers an appeal that's hard to resist.

Stock #	Description	Length	
A. PLR-580.00	Chain Nose, Serrated	5" (125mm)	\$5.95
B. PLR-580.05	Flat Nose	5" (125mm)	\$5.95
C. PLR-580.10	Round Nose	5" (125mm)	\$5.95
D. PLR-580.50	Bent Flat Nose	5" (125mm)	\$5.95
E. PLR-580.60	Needle Nose Bead Knotting Plier	5" (125mm)	\$6.95
F. PLR-580.99	4 pc Plier Set in Pouch (Contains 1 each Chain, Flat, Round, and Bent Flat Nose)		\$23.95

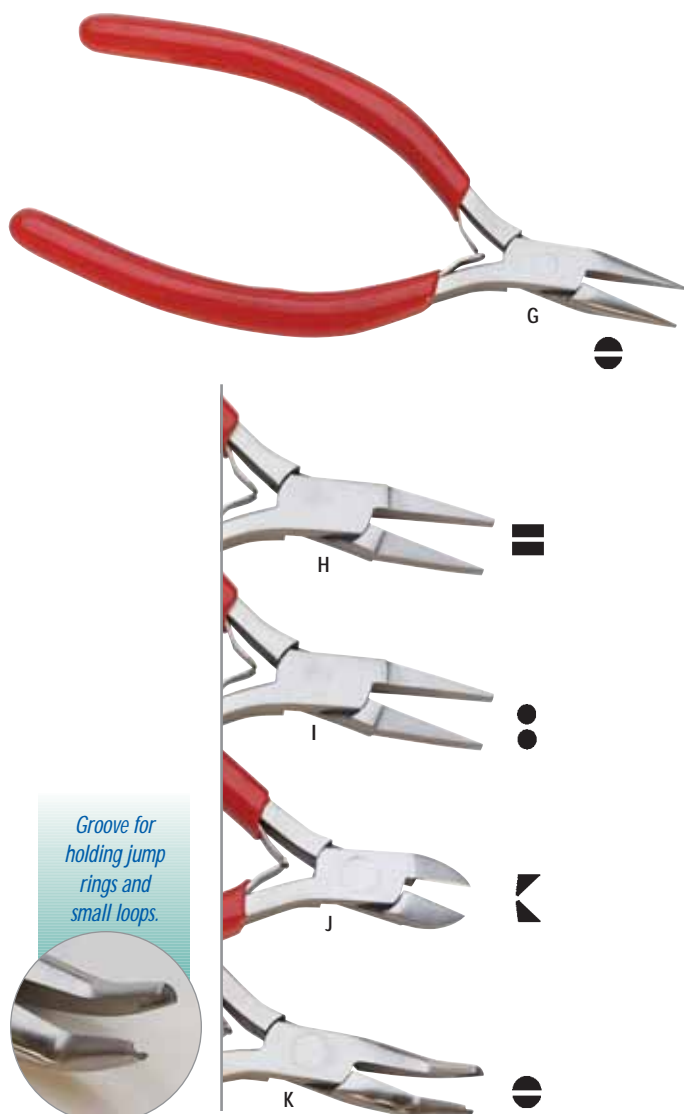

Groove for holding jump rings and small loops.

ERGONOMIC PLIERS

This series of pliers offers the user true ergonomics at very reasonable pricing. They feature precision heads and well-tapered jaws for fine or delicate work. Moreover, the handles are longer than normal but closer together when plier jaws are closed. This means less carpal tunnel stress and a more comfortable grip with less fatigue and better control. All have double leaf springs and cushion PVC grips. A real upgrade for beaders and wire artists.

Stock #	Description	Length	
G. PLR-270.00	Chain Nose	5 1/2" (140mm)	\$8.95
H. PLR-270.05	Flat Nose	5 1/2" (140mm)	\$8.95
I. PLR-270.10	Round Nose	5 1/2" (140mm)	\$8.95
J. PLR-270.15	Sidescutter – Semi-Flush	5 1/2" (140mm)	\$9.95
K. PLR-270.55	Bent Nose w/ Groove	5 1/2" (140mm)	\$9.95

See our complete range of plier pouches and racks on page 124 – 126



ZIPPERED POUCH

Use our handy leatherette four piece zippered pouch to store and transport your pliers or make your own custom sets.

Stock #	
L. BAG-210.10	\$9.95

BENDING PLIERS

Bending and Shaping pliers are indispensable for many types of applications. EURO TOOL offers a wide variety of shapes in several price ranges. Our German box-joint pliers are premium, with our Textured Grip Series an excellent quality for the cost. Our Value Series is exactly that – good value for the price.



 Concave/Convex

The concave/convex jaws are made for bending and holding rings and are perfectly smooth to protect soft metals.



 Round/Flat Nose

For looping wire or flat strips of metal.



 Flat Nose/Half-Round

With one flat jaw and one half-round jaw, these pliers are made for bending and shaping flat metal and wire.



 Round/Concave

To make sharp loops and bends in wire or metal. Designed for jump rings and other small rings.

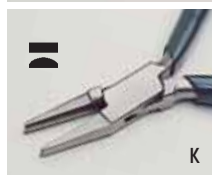

GERMAN PREMIUM SERIES BENDING PLIERS

Precision quality, box-joint pliers for all bending applications. Comfortable grips with precise alignment in four shape configurations. German-made, total length 5 1/2".

Stock #	Description	Length	
A. PLR-725.00	Concave/Convex Ring Bending Pliers	5 1/2" (140mm)	\$25.90
B. PLR-735.00	Round/Flat Nose Looping Pliers	5 1/2" (140mm)	\$20.10
C. PLR-740.00	Flat/Half-Round Bending Pliers	5 1/2" (140mm)	\$20.10
D. PLR-745.00	Round/Concave Bending Pliers	5 1/2" (140mm)	\$22.25



BENDING PLIERS with TEXTURED GRIPS

5" (125mm) bending pliers offer the best quality/price combination anywhere. Stainless steel, box-joint construction and blue textured PVC grips assure years of satisfaction. Working surfaces are highly polished to prevent scratching precious metals. You will not find better bending pliers anywhere.

Stock #	Description	Length	
E. PLR-750.25	Concave/Convex Ring Bending Pliers	5" (125mm)	\$16.95
F. PLR-750.35	Round/Flat Nose Looping Pliers	5" (125mm)	\$16.95
G. PLR-750.40	Flat/Half-Round Bending Pliers	5" (125mm)	\$16.95
H. PLR-750.45	Round/Concave Bending Pliers	5" (125mm)	\$16.95



VALUE SERIES BENDING PLIERS

Extremely well-priced series of bending pliers made in the traditional "German style" offers quality and economy for all bending applications. 5" (125mm) in length with dark green PVC handles. Excellent for bead and wire work.

Stock #	Description	Length	
I. PLR-495.25	Concave/Convex Ring Bending Pliers	5" (125mm)	\$9.95
J. PLR-495.35	Round/Flat Nose Looping Pliers	5" (125mm)	\$9.95
K. PLR-495.40	Flat/Half-Round Bending Pliers	5" (125mm)	\$9.95
L. PLR-495.45	Round/Concave Bending Pliers	5" (125mm)	\$9.95



A

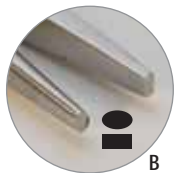

B



C

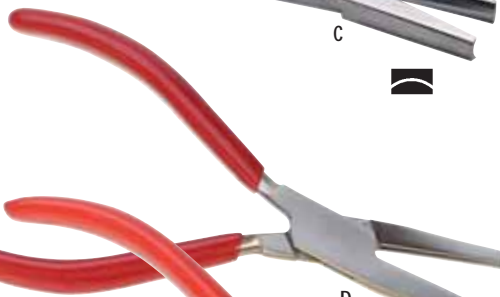

D

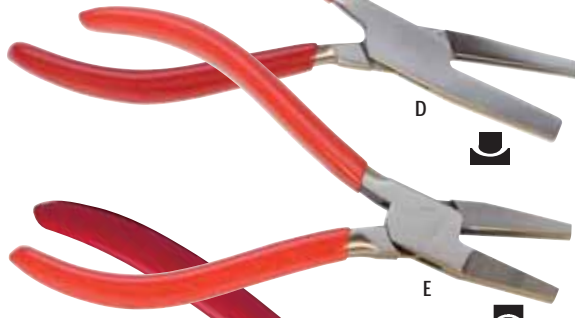

E

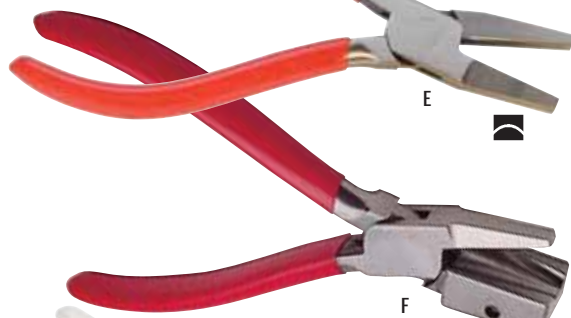

F

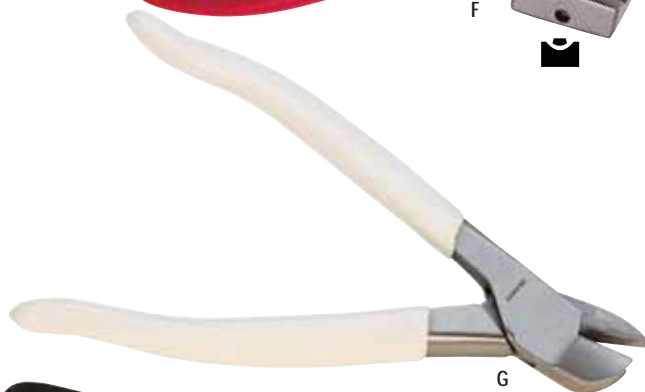

G



H

JUMBO FORMING PLIERS

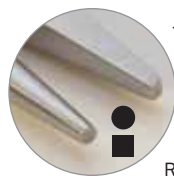

Our new forming pliers feature a larger jaw for popular Chain Maille work, and bending or coiling of heavier gauge wire. Large handle allows for needed torque, even for those with smaller hands. Available in Oval/Rectangle Jaws and Round/Square Jaws with box joint construction. Jumbo forming pliers are necessary for thicker wire and other metals. The jaws are 1 $\frac{3}{8}$ " long with the round jaw tapering from 10 to 4.0mm.

Stock #	Description	Length	
A. PLR-724.00	Square/Round Bending	7 $\frac{1}{2}$ " (190mm)	\$17.95
B. PLR-724.50	Rectangle/Oval Bending	7 $\frac{1}{2}$ " (190mm)	\$20.75

LARGE RING BENDING PLIERS

Great pliers for those extra-heavy bending jobs. Jaws are concave/convex for shaping shanks. Edges are rounded so they will not mar metal. German model is lap-joint construction and the economy model is box-joint.

Stock #	Description	Length	
C. PLR-720.00	German Model, Lap Joint	6 $\frac{1}{2}$ " (165mm)	\$31.90
PLR-720.05	Economy Model, Box-Joint	6 $\frac{1}{2}$ " (165mm)	\$15.60

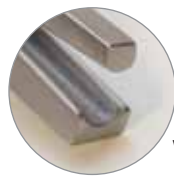

NARROW JAW BENDING PLIERS

The half-round jaw is narrower than our other bending pliers. Jaw is only 6.0mm which facilitates bending smaller rings with finer shanks. Box-joint construction with PVC grips.

Stock #	Length	
D. PLR-721.05	6 $\frac{1}{4}$ " (160mm)	\$15.60



RING BENDING PLIERS

This large 6 $\frac{1}{2}$ " German-made ring bending plier has a box-joint with cushion grip handles for maximum leverage. Jaws are concave/convex for shaping shanks, with the convex jaw being slightly thinner than the concave jaw. Grounded edges on the concave jaw minimize marring of precious metals. This is undoubtedly the finest bending plier available.

Stock #	Length	
E. PLR-723.00	6 $\frac{1}{2}$ " (165mm)	\$38.55

CONCAVE RING BENDING PLIERS

This unique box-joint plier is made to round any size ring due to its exclusive shape. The lower (concave) jaw goes from 10.50mm at the tip to 17mm at the base, something no other bending plier does. Its inner surface is highly polished tool steel and the edges are rounded so that it will not mar precious metals.

Stock #	Length	
F. PLR-722.00	6 $\frac{1}{2}$ " (165mm)	\$51.40



HEAVY-DUTY RING BENDING PLIERS

These extra-heavy pliers are used for bending metal at right angles, closing bows and bending ring shanks.

Stock #	Description	Length	
G. PLR-730.00	German Model	6 $\frac{1}{2}$ " (165mm)	\$39.95
PLR-730.05	Economy Model	6 $\frac{1}{2}$ " (165mm)	\$19.85

BENDING PLIERS

This practical flat stock and wire shaper features parallel jaws to bend heavy wire and flat stock up to six gauge. Pliers can be used for making small rings, bracelets and other circular objects. Made of tool steel with non-reflective black finish and cushion grips, this tool will give you years of service.

Stock #	Length	
H. PLR-734.00	7" (180mm)	\$49.99

Don't settle for anything less than the original Nylon Jaw Pliers by EURO TOOL!

NYLON JAW PLIERS

The original EURO TOOL nylon jaw pliers are a must for straightening wire, especially colored wire. Not just any nylon jaw will do and ours are a high quality nylon which will not damage delicate wire. Stainless, box-jointed with comfort grips. Available in three styles, one with spring. Replacement jaws available. Don't settle for less.

Stock #	Description	Length	
A. PLR-829.00	Thin Nose Nylon Jaw Plier	5 3/4" (145mm)	\$19.95
B. PLR-830.00	Nylon Jaw Plier	5 3/4" (145mm)	\$22.50
C. PLR-831.00	Nylon Jaw Plier with Spring	4 3/4" (120mm)	\$13.95
PLR-829.05	Repl. Jaws for PLR-829.00 (pr)		\$4.15
PLR-830.05	Repl. Jaws for PLR-830.00 (pr)		\$4.15
PLR-831.05	Repl. Jaws for PLR-831.00 (pr)		\$4.15



GLITTER LINE™ NYLON JAW PLIERS

Now available in our EURO TOOL Glitter Line, inexpensive nylon jaw pliers for holding, bending and straightening color and precious metal wire. The size makes these especially desirable as they are smaller than most and easier to manipulate. The nylon that we use is excellent quality assuring the user will not damage wire or other materials.

Stock #	Length	
D. PLR-255.30G	4 1/2" (115mm)	\$10.95

ULTRA ERGO NYLON JAW PLIERS

Our Ultra Ergo Nylon Jaw pliers give the user great leverage and comfort. Made of high grade stainless steel with quality nylon jaws.

Stock #	Length	
E. PLR-275.30	5 3/4" (145mm)	\$15.95

RING BENDING PLIERS

A EURO TOOL exclusive, this plier is an eminently superior replacement for the three-jawed pliers known as bow-closing pliers, which are often used for reshaping rings. This tool, however, will never scratch a ring since the V-block is nylon and the single jaw is highly polished stainless steel.



Stock #	Description	Length	
F. PLR-835.00	Ring Bending Plier	5 1/4" (135mm)	\$24.35
PLR-835.05	Replacement Jaws		\$4.15

BRACELET BENDING PLIERS

With a gentle arc for bracelets, the nylon jaws of this plier cannot scratch. Makes reshaping bracelets easy. Order extra sets of nylon jaws and customize your own shape jaws for any task by simply carving the nylon with a knife.



Stock #	Description	Length	
G. PLR-840.00	Bracelet Bending Plier	5" (125mm)	\$20.35
PLR-840.05	Replacement Jaws (pair)		\$4.15

BENDING PLIERS

Bending pliers also feature replaceable nylon jaws for bending rings sizes 6 1/2 and larger. Like our other nylon jaw pliers, this one cannot scratch, saving the jeweler time, work and money.



Stock #	Description	Length	
H. PLR-841.00	Bending Plier	5 1/4" (135mm)	\$20.85
PLR-841.05	Replacement Jaws (pair)		\$4.15



For a quick wire straightener, see our nylon jaw tweezers – page 216.

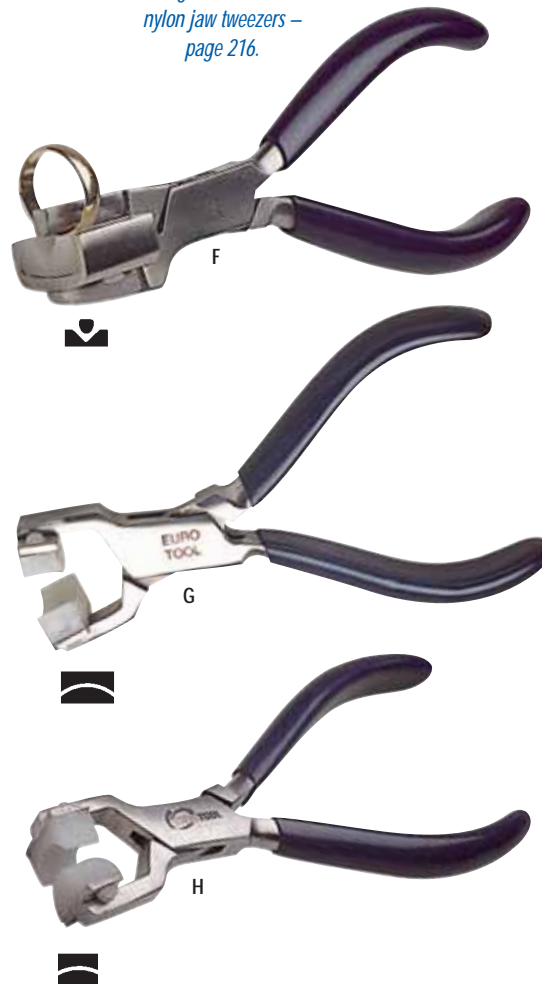

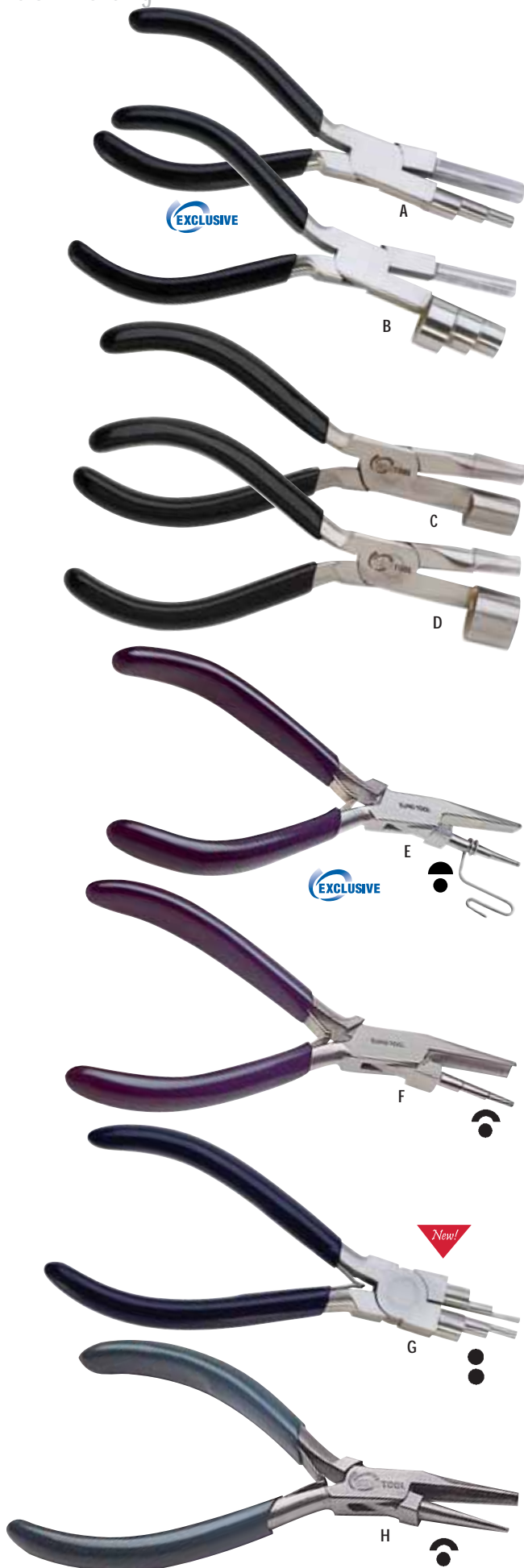

MULTI-SIZE WRAP 'N' TAP PLIERS

Our Multi-Size Wrap 'n' Tap Pliers offer the user greater versatility. We have two sizes available. With these sizes you can shape rings for children, ladies or gents sizes or make consistent loops in many sizes. Very little tapping is necessary and half-round wire will not twist, scratch or deform. Pliers are especially good for hollow stock or looping stock that has a pattern. The Wrap 'n' Tap Pliers feature cushion grips and are made of stainless steel. 6 1/2" (165mm) in length

Stock #	Description	Barrel Size	
A. PLR-746.02	Multi-Size Wrap 'n' Tap	5, 7, 10mm (3/16", 1/8", 3/8")	\$28.95
B. PLR-746.03	Multi-Size Wrap 'n' Tap	13, 16, 20mm (1/2", 5/8", 3/4")	\$28.95



WRAP 'N' TAP RING LOOPING PLIERS

A revolutionary idea, simple, yet extremely effective, invented and patented by a master jeweler. We call them Wrap 'n' Tap Ring Looping Pliers, because the jeweler can wrap ring stock around the barrel shaped jaw, then tap it slightly on a mandrel and instantly make a complete ring, half or quarter shank for repair. Two sizes available, 14mm barrel for ladies' rings and 19mm barrel for gents' rings and coin mountings. Pliers are especially good for hollow rings and rings with a design on one side, because the lower jaw is covered with PVC tubing and cannot scratch or mar. You get a perfect circle time after time, with stock up to 2mm thick. Made of stainless steel with PVC cushion grips.

Stock #	Description	Length	
C. PLR-746.14	14mm Barrel, Ladies' Sizes	6" (150mm)	\$22.95
D. PLR-746.19	19mm Barrel, Gents' Sizes	6" (150mm)	\$22.95

MASTER COILER

Our "Master Coiler" is the painless plier. It is developed to make loops and coils without nicking precious wire which can cause a great deal of psychological pain to the user – not to mention what it does to the wire. Normal concave/convex pliers nick, but the "Master Coiler" allows one to hold the wire with the flat jaw while rotating the round jaw to form the perfect loop! Comfort grips, non-rust highly polished stainless steel jaws and standard step-jaw for consistent loops and coils.

Stock #	Length	
E. PLR-747.00	5 3/4" (145mm)	\$11.95

WIRE LOOPING PLIERS

Stainless steel wire looping pliers, also known by model train enthusiasts as coupling pliers, enable the user to bend wire easily. Three round jaws in one and box-jointed for durability. Finely polished jaws, one being round and the other concave.

Stock #	Length	
F. PLR-748.00	5 3/4" (145mm)	\$11.95



MULTI-SIZE LOOPING PLIERS

Why have three separate looping pliers when you can have one that does the job of three? Our Multi-Size Looping Pliers can make a variety of loops ranging from 2mm to 9mm for a variety of combinations. Made of stainless steel with double leaf springs, these pliers are another first from EURO TOOL.

Stock #	Length	
G. PLR-736.00	6" (150mm)	\$16.95

ECONOMIC BENDING PLIERS

Make sharp loops and bends with this economy bending plier. One jaw is round and the other is concave.

Stock #	Length	
H. PLR-490.40	5 1/4" (135mm)	\$7.15



GROOVY CHAIN NOSE PLIERS by WOLF TOOLS®

Kate Wolf has solved the problem of making nice right angle bends in wire by creating what she calls the "Groovy Chain Nose Pliers." One side of the jaw is perfectly straight and the groove aligns the wire or flat pieces at a perfect 90° angle every time. Made of stainless steel, pliers feature ergo handles with PVC grips, dual-leaf springs, and box-joint construction.

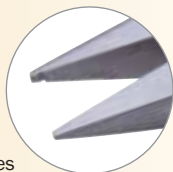

Stock #	Description	Length	
A. PLR-752.00	Wolf™ Groovy Chain Nose Pliers	5¾" (145mm)	\$16.95

GROOVY LOOPING PLIERS by WOLF TOOLS®

The Groovy Looping Pliers, designed by Kate Wolf, enable the user to repeat three exact sizes of loops when wire wrapping, making earring loops or similar tasks. The round jaw is smooth with a nice taper. The flat jaw tapers to the point so that the user can see exactly what she is doing during fabrication. Made of stainless steel and box-jointed with dual leaf springs. Also available without grooves for a more traditional, yet improved looping plier.

Stock #	Description	Length	
B. PLR-751.00	Wolf Groovy Looping Pliers	5" (125mm)	\$16.95
C. PLR-753.00	Wolf Looping Pliers (no grooves)	5" (125mm)	\$15.95



NARROW FLAT NOSE PLIERS

An extra narrow flat nose plier has been requested many times. This model with PVC grips and dual-leaf springs is perfect for smaller jobs, especially making 90° angles with wire. With sturdy box joint jaws, the nose tapers to a thin 2.2mm making it perfect for finer applications. Material is brushed stainless for long life.

Stock #	Length	
D. PLR-491.36	4½" (115mm)	\$7.95

MINIATURE PRECISION COILER - GERMAN

German-made bending plier essential for making smaller coils. Round jaw measuring 1.10mm at the tip combined with a flat jaw of 2.50mm at the tip, gives the user precise handling capabilities. Double-leaf return springs and comfortable PVC grips.

Stock #	Length	
E. PLR-101.35	4½" (115mm)	\$22.30

MICRO TWISTER #2

One jaw flat, one round for wire wrapping and bead stringing. With double-leaf springs, box-joints and PVC comfort grips, this plier is an essential for every bench.

Stock #	Length	
F. PLR-491.35	4½" (115mm)	\$7.95

NYLON JAW COILING PLIERS

Nylon jaw pliers for coiling delicate wire or sheet metal. These pliers are both economical and functional. Nylon jaw simply won't scratch. Construction is box-joint, stainless steel with PVC grips.

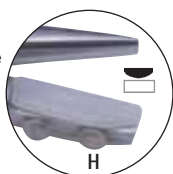

Stock #	Description	Length	
G. PLR-846.00	Round and Flat Jaw	5½" (140mm)	\$13.95
PLR-846.05	Repl. Jaw for PLR-846.00		\$2.25
H. PLR-847.00	Half-Round and Flat Jaw	5½" (140mm)	\$13.95
PLR-847.05	Repl. Jaw for PLR-847.00		\$2.25

SINGLE NYLON JAW COILING PLIERS

Now available in our Glitter Line™ or comfortable Ultra Ergo line. Both offer quality single nylon jaw for precision coiling.

Stock #	Description	Length	
I. PLR-255.35G	Glitter Nylon Jaw	4½" (115mm)	\$10.95
J. PLR-275.35	Ultra Ergo Nylon Jaw	5¾" (145mm)	\$15.95



Tips are a narrow
2.2mm wide!

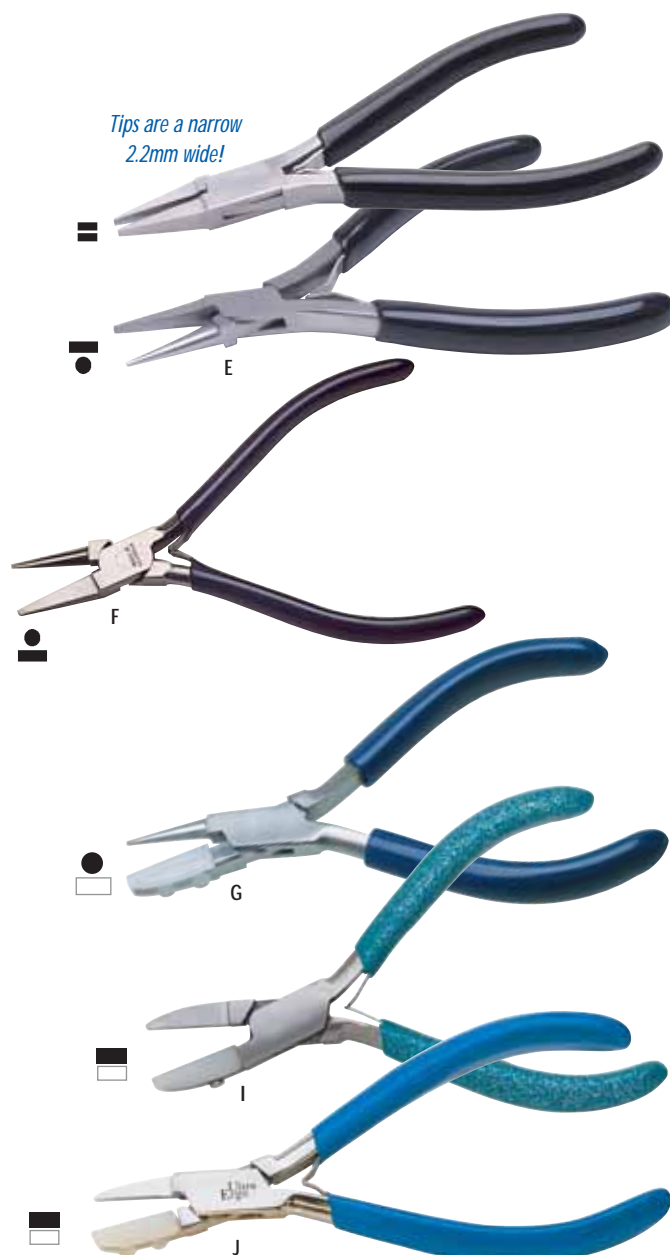

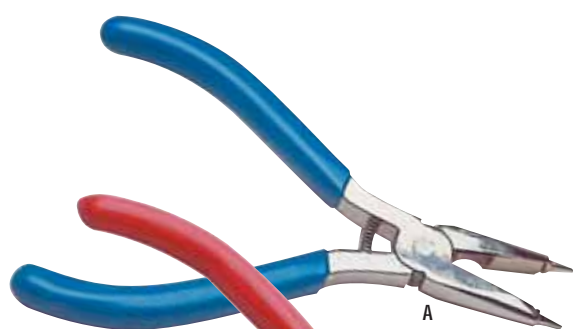

A

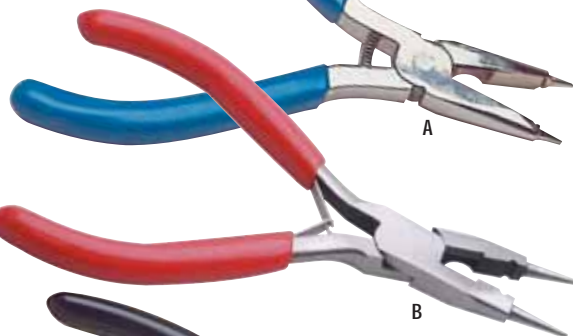

B

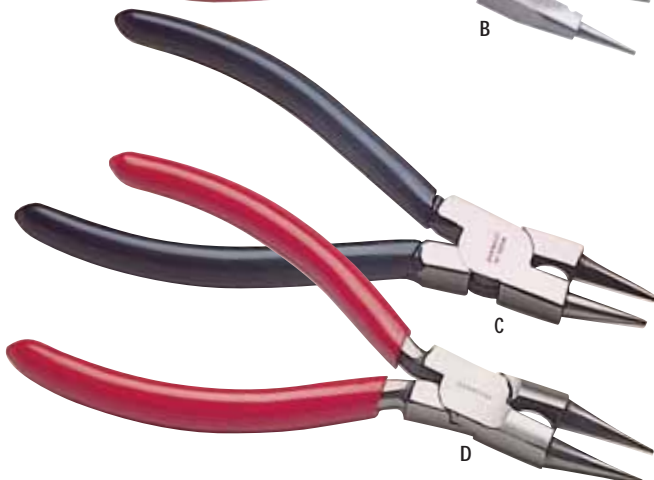

C



D

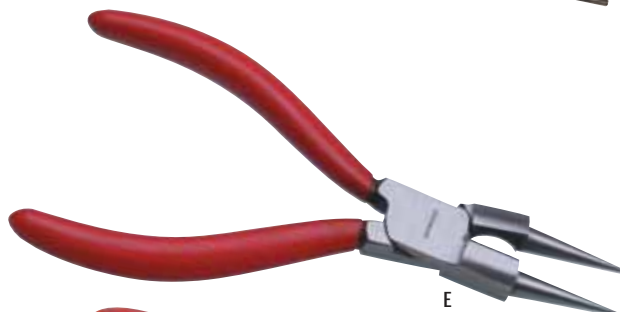

E



F



G

BEADER'S DELIGHT PLIERS

This unique plier, developed by EURO TOOL is an essential for bead stringers and wire wrappers because it is a multi-task tool. It offers a round nose for coiling wire, a flat jaw for flattening, straightening or bending at right angles, a groove for closing coils or jump rings and a sidecutter. Made of stainless steel with a gentle coil return spring and cushion grip handles for comfort.

Stock #	Length	
A. PLR-577.00	4 ³ / ₄ " (120mm)	\$12.95

FOUR-IN-ONE BEADER'S DELIGHT

Developed by EURO TOOL, this plier is our Four-in-One "Beaders' Delight." A must for wire wrappers too because it offers a finely tapered long nose for coiling, a flat jaw for flattening, straightening or bending, a groove for closing coils and jump rings, plus sidecutter. Great for travel with PVC grips, double-leaf springs.

Stock #	Length	
B. PLR-577.10	5" (130mm)	\$9.95

ROSARY PLIERS – GERMAN

German-made rosary pliers feature lap-joint construction with PVC grips and a round nose for bending and looping wire. Each features a sidecutter which is well-angled and cuts clean, thanks to the jaws which meet perfectly. The smaller rosary plier is especially suited for bead stringers, wire wrappers or people with smaller hands. It offers a narrower side to get into tighter places when cutting.

Stock #	Description	Length	Jaw Length	
C. PLR-574.00	German Rosary Pliers	5" (125mm)	5/8"	\$19.95
D. PLR-576.00	German Rosary Pliers	5 ¹ / ₄ " (135mm)	3/4"	\$23.05

LONG NOSE HEAVY DUTY ROSARY PLIERS - GERMAN

Our largest rosary plier for those who want premium quality. Made in Germany of the finest carbon steel. The nose is 1" (24mm) long, with a diameter of 1.30mm at the tips. The cutter on this model is much better than most. Lap-joint construction and offered without springs to ensure a precise touch.

Stock #	Description	Length	Jaw Length	
E. PLR-575.00	Heavy Duty Rosary Pliers	5 ¹ / ₂ " (140mm)	1"	\$35.10

ROSARY PLIERS with SPRINGS

A large rosary plier with springs is preferred by some people. Our economy models are well-made but reasonably priced rosary pliers. Nicely finished, cuts clean and has well-rounded jaws with a nicely tapered long nose. Offers good leverage, finish and value.

Stock #	Description	Length	Jaw Length	
F. PLR-573.00	Lap Joint	5 ¹ / ₄ " (130mm)	7/8"	\$11.50
PLR-572.00	Box Joint	5 ¹ / ₂ " (140mm)	3/4"	\$9.90

POCKET ROSARY

Take this "go anywhere" plier with you. Only 3" in length yet capable of making loops, bends and cuts just like a full size rosary pliers. Lap-joint construction with leaf springs.

Stock #	Description	Length	Jaw Length	
G. PLR-430.18	Pocket Rosary	3" (75mm)	3/4"	\$3.95

EURO CRIMPERS – Bead Crimping Pliers

The revolutionary tool brought to you by EURO TOOL is now offered in four styles – all designed specifically for various size crimps, crimp covers and even crimp ends. With the patented design of our crimpers you will get smooth rounded crimps, rather than flattened crimps with sharp or pointed edges as you do using conventional pliers. The PVC handles are designed for maximum comfort and leverage. All three sizes are made of high grade steel, with non-glare black oxide finish, and the jaws are precision ground to assure perfect crimps for years. For best results only high quality crimps should be used. Each of the pliers comes with complete instructions. Patents: D356,520; 5,426,843; DES. 366,199.

- A. **Original Bead Crimper** for beads from 2 to 3 mm which works with either tube crimps or round crimps. We recommend that you use round (spherical) crimps if the crimp is going to be hidden, as they hold better than tube crimps. Tube crimps are more attractive when they are to be seen.
- B. **The Mighty Crimper** was developed for larger beads of 3mm diameter, and is exceptionally handy for closing crimp ends, eyelet ends, cap end, pinch clasps and crimp covers. Because of the rounded jaws, it will leave no marks or flat spots. Because of its larger size, the Mighty Crimper is made of slightly thicker steel, giving it 2.2mm wide jaws which are precision milled.
- C. The **Micro Crimper** is also an adaptation of the Original Crimper, to be used with 1mm size crimps. It too has precision ground jaws, which are slightly thinner for the smaller crimps which have become popular with the introduction of finer wire.
- D. Now you can crimp any crimp bead of “medium” size (2mm – 3mm) and various shapes – quick and easy! The **Dual EuroCrimper™** has two forming cavities for round, tube and combination crimps of slightly varying sizes. But wait...the new, true ergonomic handles give you a great grip, too, because they are made from sanoprene – a special compound – with excellent surface tack. Like our other patented crimpers, **Dual EuroCrimper™** jaws are precision machined for years of service and beautiful results every time.

Stock #	Description	Length	
A. PLR-585.00	Original Bead Crimper	5" (125mm)	\$13.45
B. PLR-584.00	Mighty Crimper	5 1/4" (135mm)	\$14.95
C. PLR-586.00	Micro Crimper	5" (125mm)	\$13.45
D. PLR-582.00	Dual EuroCrimper	5 3/4" (145mm)	\$16.95

EXCLUSIVE



How to Form the Perfect Crimp

At the last bead (A), pass the jewelry wire (B) through the crimp bead or tube (C) then through the clasp or jump ring (D) - back through the crimp (C) - and optionally back through the end bead (A).

Step 1 - secure the crimp in the crimping station (E). Best results are obtained when the two wires are positioned on either side of the center dimple.

Step 2 - final shaping in the rounding station (F) - forming a smooth, rounded crimp.

NOTE: When bead stringing it is important for the bead crimp to match whatever wire that one is using. The worst case is using too large of crimp with finer wire, then the crimp may not close enough to hold properly. Always test that the crimp is secure on the wire.

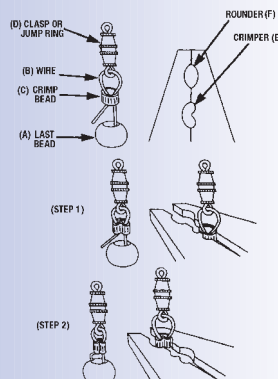

Visit our website to see the bead crimping instructional video at www.eurotool.com



LOOP-CLOSING PLIERS

Small hollow jaws for holding and closing jump rings, small loops, etc. Made of stainless steel and now with narrower jaws.

Stock #	Description	Length	
A. PLR-718.00	With Cushioned Grips	5 1/2" (140mm)	\$10.80
PLR-718.24	Without Grips	5 1/2" (140mm)	\$7.95



EURO JUMP RING PLIERS

Why use bulky awkward pliers for placing and closing jump rings when you can use our Jump Ring Pliers? Because the jaws come to a point and are nicely grooved, you can close jump rings without scratching the ring itself. These pliers also allow the user to get into tight places and hold the jump ring for soldering.

Stock #	Description	Length	
B. PLR-260.55	Jump Ring Pliers	4 1/2" (115mm)	\$11.95



SPLIT RING PLIERS

A EURO TOOL original, this is a much needed tool which opens split rings easily. Just put the tooth jaw between the overlapping split ring and squeeze. The split ring pops open, ready for the user to put on chains, etc.

Stock #	Description	Length	
C. PLR-589.00	Traditional Coated Handles	5 1/4" (135mm)	\$7.95
D. PLR-588.00	Ergonomic Grips	5 1/2" (140mm)	\$8.45

EURO TOOL®
original

Opens split-rings in a snap!



LINKING RING

Our linking rings are extra handy for opening and closing jump rings of various sizes. With a chain nose plier and our linking ring, one can open and close jump rings with ease and accuracy, without damaging other parts on necklaces, earrings, etc. Linking rings are stainless steel and have three different size grooves to fit various jump rings.

Stock #		
E. HOL-169.00		\$2.95

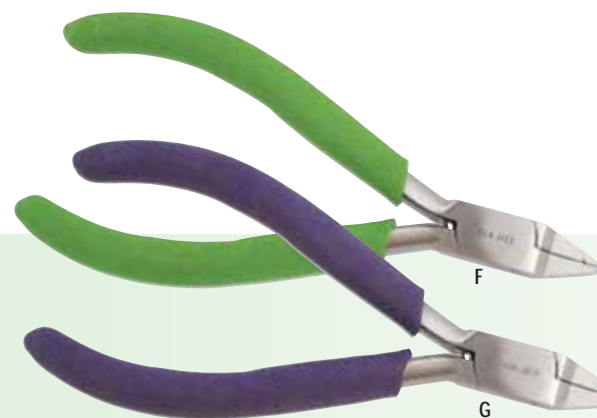

MAGICAL CRIMPER

This tool was created exclusively for use with 2mm sterling silver and gold-filled tubular crimp beads and .019" or .014" flex wire. Just a few easy steps will transform a 2mm crimp into a round bead.

Stock #	Description	
F. PLR-578.04	Magical Crimper for .014 Wire	\$19.95
G. PLR-578.05	Magical Crimper for .019 Wire	\$19.95



"OUCHLESS" RING HOLDING PLIERS

Our new PLR-738.00 makes it easy for jewelers to hold rings while filing or doing other work on prongs. The blunt nose assures that the piece is held closely and securely. With this plier, one can avoid injury to thumb and fingers when doing delicate jobs. Double-leaf springs and ergonomic black grips.



Stock #	Length	
A. PLR-738.00	5 1/8" (130mm)	\$15.95

RING-HOLDING PLIERS

Hollow jaws hold rings while work is being done, particularly polishing the inside of a ring. Made of stainless steel with box-joints and cushioned grips.

Stock #	Length	
B. PLR-715.00	5 1/2" (140mm)	\$11.90

RING HOLDING PLIERS

For holding rings while polishing the inside or doing other work. The nylon, parallel-type jaws hold rings or other circular objects securely without scratching. We think that this plier will make other ring holding pliers obsolete. Total length of 5 1/2" (140mm).



Stock #	Description	Length	
C. PLR-842.00	Ring Holding Plier	5 1/2" (140mm)	\$22.15
PLR-842.05	Replacement Jaws (pair)		\$4.15

LONG NOSE LOOPING PLIER

Excellent for wire wrap and bead artists, our looping pliers are made in Germany. Our Large Looping pliers feature one jaw which is flat and tapered, the other perfectly round, and both are an extra long 1 3/8" (25mm). With box-joint construction, the user can bend wire easily. The long tapered round jaw goes from 1.25mm to 5.40mm in diameter to assure the user of consistent loops. Pliers feature double-leaf springs and PVC comfort handles.

Stock #	Length	
D. PLR-301.35	5 3/4" (145mm)	\$23.10

FINE CURVED NOSE BEADING PLIERS

Developed by a professional bead stringer/wire wrapper, this fine curved nose beading plier is handy for many delicate jobs. The narrow nose allows the user to bend looped or coiled ends so that they will not catch, which also gives a more finished look. Jaw angle facilitates easy usage. Jaws are a fine 1.0mm at the tip and measure 1 1/8" (30mm) in length. Overall length is 5 1/2" (140mm). Features include double-leaf springs and PVC grips. Made in Germany.



Stock #	Description	Length	Jaw Length	
E. PLR-351.00	Curved Nose Pliers	5 1/2" (140mm)	1 1/8"	\$22.40

NEEDLE NOSE PLIERS

This plier has extra-long jaws for specialty applications. Box-joint, needle-nose pliers are German-made, with the superior finish that makes our precision lines so popular. 5 3/4" (145mm) with 7/16" jaws.

Stock #	Description	Length	Jaw Length	
F. PLR-560.00	Needle Nose Pliers	5 3/4" (145mm)	7/16"	\$23.05

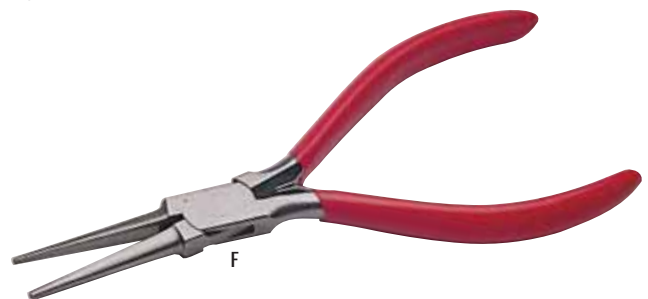
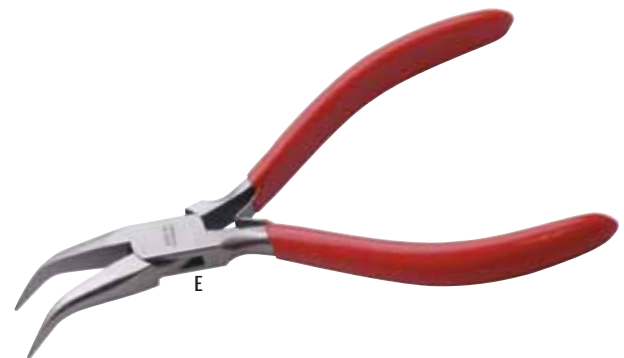
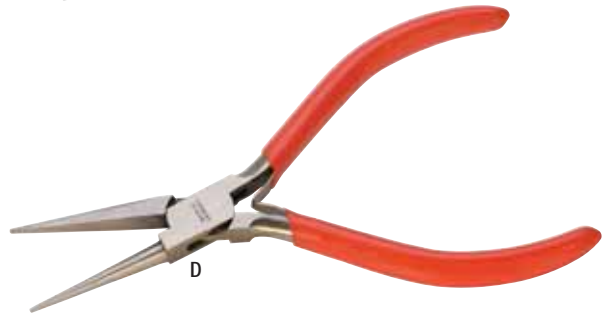
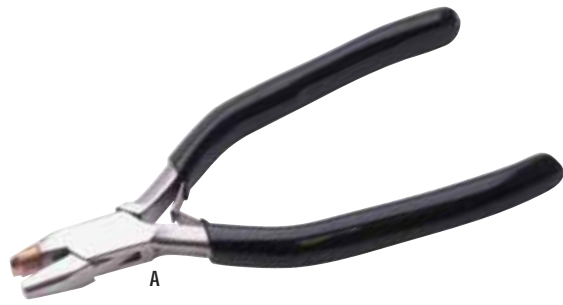



A



B



C



D



E



F



#1 CONNER BEAD SETTING PLIERS

The #1 Conner Pliers will replace the common beading tool on a great many jobs, making them considerably easier. No longer will you need to hold items in the ring clamp and on the bench pin, or fill a fragile item with shellac. Can be used to hold stones (cutlet to table) while being heat set into wax models. This tool will give you the support from the underside you need to do common, everyday tightening and settings in stones, plus many other applications.

Stock #	Length	
A. PLR-159.00	4 1/2" (115mm)	\$14.95



#2 CONNER SETTING PLIERS

The #2 Conner Pliers are especially helpful to set or tighten side stones in a basket setting as well as on other type mountings. One side of the plier has a slot for the wire under the stone and the other side has a beading tool cup on it. Also great for setting earrings – with or without underbezel wires. Simply slip the post through the slotted side and bring the beading tool down on the prong making this type of work much quicker and easier. Perfect for setting and tightening accent diamonds surrounding color center stones.

Stock #	Length	
B. PLR-160.00	4 1/2" (115mm)	\$14.95

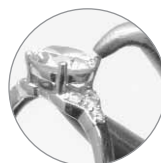

"POWER SET" PLIERS

Invented by a stone setter, our new "Power Set" pliers can be used for setting virtually any size stone. The top (bent) jaw has a concave hole, which works great on prongs or pave set stones. The straight jaw is milled so that the plier can be used on normal mountings as well as basket mountings and many more. Made of high grade stainless steel with cushion grips, this plier can save the user a great deal of time when repairing or setting stones.

Stock #	Length	
C. PLR-165.00	5 1/2" (140mm)	\$16.95



PRONG-OPENING PLIERS

A revolutionary idea! A plier for opening prongs which will not fracture stones. The user has total control no matter what size prong. The plier puts no pressure on the top of the stone. Top jaw is a claw which grips the prong cleanly and the lower jaw is grooved to hold the prong. Made in Germany.

Stock #	Length	
D. PLR-132.00	4 1/2" (115mm)	\$27.45



PRONG-OPENING PLIERS

German-made pliers feature a thinner claw to get in behind prongs. The angle and length of the bottom jaw provides precise leverage to minimize damage to stones. The lower jaw is grooved so that it doesn't slip sideways on the prong. The claw is made to be filed to a fresh point as it wears. Box-joint with PVC grips. A EURO TOOL original.

Stock #	Length	
E. PLR-158.00	5 1/4" (135mm)	\$39.30

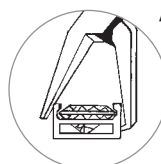

"PERFECT SET" PLIERS

A unique design, specifically for closing prongs on tennis bracelets quickly, efficiently and properly. The angled jaw allows the user to properly bend the prong, making every setting job much easier than with conventional pliers. "Perfect Set" pliers also work great for setting stones on pins, cuff links, coin rings and promotional jewelry.

Stock #	Length	
F. PLR-133.00	5" (125mm)	\$11.95

PARALLEL GEMSETTING PLIER

Safely set stones with minimum effort and maximum control. Gemsetting pliers close with a parallel motion so even pressure is applied when closing prongs and thus reduces the chance of damage to the stone. Jaws are easily adjusted by turning the opening adjustment wheel. 10:1 lever ratio allows you to set stones with less force than required with conventional pliers. The adjustment screw allows precise movement predetermined distance set by the jeweler. Works well with prongs and settings of all sizes and shapes. Easy to control and grip with the lever-action handle and limited travel distance. Simply adjust to fit the prong. Then gently squeeze to bend the prongs.

Stock #

A. PLR-870.00

\$31.95

**ZIG ZAG SETTING PLIERS**

Invented by a stone setter, these newly developed pliers sit at just the right angle to bend prongs over without damaging stones. Box-jointed and made of high grade stainless steel, these little pliers can save the jeweler a lot of time and trouble. Length 4¾". A EURO TOOL exclusive.



Stock # Length

B. PLR-708.00 4¾" (120mm)

\$16.45

**STONE-SETTING PLIERS**

Stone-setting pliers have one smooth jaw and one notched jaw for bending and tightening prongs. The highly polished fine jaws allow access to tight spots. Ours are the best available in their price range. Your satisfaction is guaranteed.

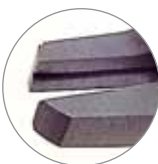

Stock # Description Length

C. PLR-700.00 German Model 5" (125mm) \$33.95

D. PLR-705.00 Standard Model 5" (125mm) \$12.80

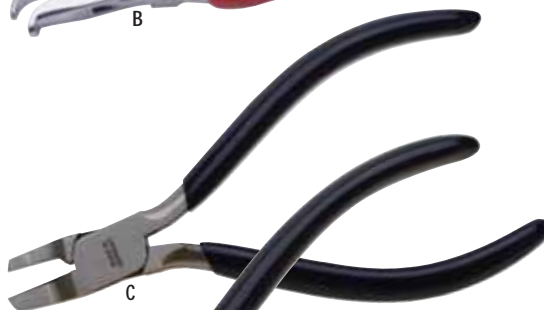
**STONE SETTING PLIER with GROOVE**

Another new idea to save time and assure that the job is done correctly. Pliers are shaped similar to other stone setting pliers, but one jaw is grooved and notched so that earring setting can be inserted as pictured. Gently squeeze and the prong folds over perfectly every time. Pliers are stainless steel and precision engineered to last a lifetime.



Stock # Length

E. PLR-711.00 5¼" (135mm)

\$14.95

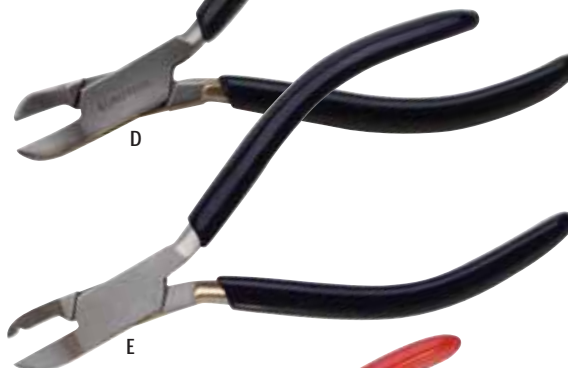
**PRONG-CLOSING PLIERS**

Bent nose pliers with grooves so that the tip doesn't slip off when closing prongs. Recommended for stone setters working with small prongs. A EURO TOOL original. Made in Germany.



Stock # Length

F. PLR-155.00 4½" (115mm) \$24.25

PLR-355.00 5" (125mm) \$26.80

**90° BENT NOSE PLIERS**

Our 90° bent nose pliers are the perfect tool for stone-setting, especially for small prongs and tennis bracelets. The 90° angle makes precise work easier because prongs are more visible to see and control is enhanced. Measures 5" (125mm) long with box-joint construction, cushion grips and a removable leaf spring.

Stock # Length

G. PLR-756.00 5" (125mm)

\$11.95



**Only from
EURO TOOL!**



A

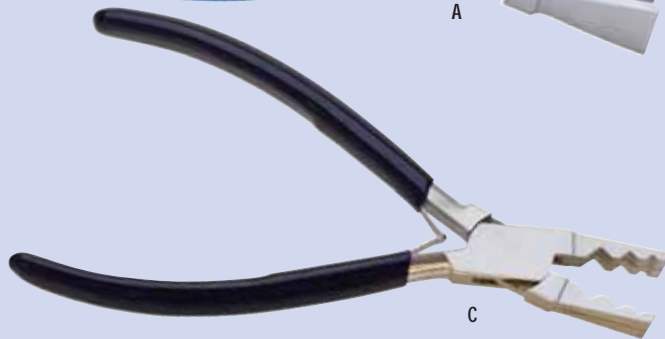

C



D



E

See our instructional video on
the Coil Cutting Pliers –
www.eurotool.com



F

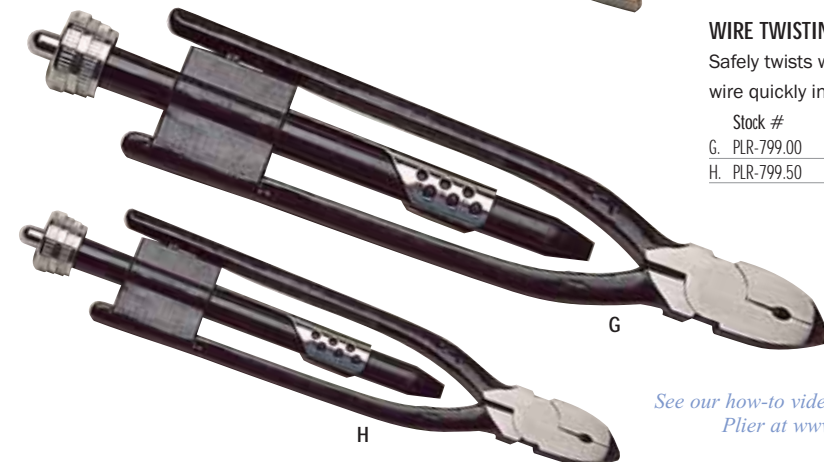

G

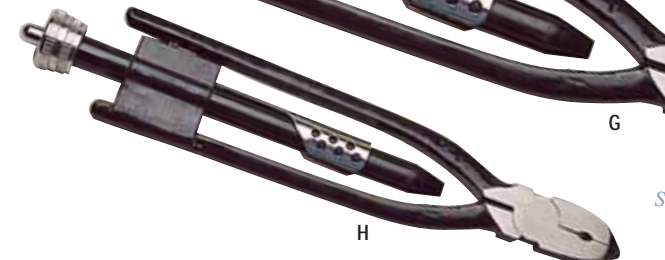

H



B

DUCK BILLED METALSMITH PLIERS

Duck billed metalsmith pliers offer a great alternative when holding flat stock for finishing. With box joint construction, jaws are 1 $\frac{1}{4}$ " long and $\frac{5}{8}$ " wide at the tip. The handles are our new Ultra Ergo design.

Stock #	Description	Length	
A. PLR-754.00	Duck Billed Metalsmith	6 $\frac{1}{2}$ " (165mm)	\$16.95
B. PLR-754.50	Duck Billed Metalsmith with Urethane Jaws	6 $\frac{1}{2}$ " (165mm)	\$19.95

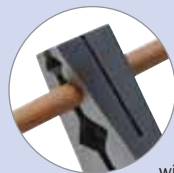

TUBE CUTTING PLIERS

Tube Cutting Pliers make it easy for the user to hold tubing or small rods while sawing. This version of the duck billed pliers features a narrow groove down the center of the jaws for the sawblade to follow, making it quick and simple. Pliers will hold tubing from 2.0 up to 10mm outside diameter.

Stock #	Length	
C. PLR-833.00	7" (175mm)	\$26.95



NYLON JAW TUBE HOLDING PLIERS

Tube Holding Pliers are made to hold tubing gently but firmly when cutting, filing or doing other operations. Nylon jaws are designed to hold virtually every size tube and will not scratch. Jaws may be replaced.

Stock #	Description	Length	
D. PLR-848.00	Nylon Jaw Tube Holding Pliers	6 $\frac{1}{2}$ " (165mm)	\$24.99
PLR-848.05	Replacement Jaw (pr)		\$4.95



COIL CUTTING PLIERS

This unique tool holds wire coils so that they can be efficiently cut into jump rings. Made of stainless steel, the Coil Cutting Pliers feature a jaw which firmly but gently grasps coils ranging from 4.50 to 9.0 mm (outside diameter). The jaws feature slits that allow the user, with a jewelers saw and a 2/0 sawblade, to quickly cut multiple jump rings. Pliers are box-jointed, with PVC comfort grips.

Stock #	Length	
E. PLR-819.00	7" (175mm)	\$28.95

BRASS JAW FLAT NOSE PLIERS

Our 5" box-jointed, flat nosed pliers with brass jaws enable the user to hold and bend metals scratch free. The body of these pliers are rust-free stainless steel with double-leaf springs.

Stock #	Length	
F. PLR-755.00	5" (125mm)	\$13.90

WIRE TWISTING PLIERS

Safely twists wire up to 18 ga. Simple one-pull action and automatic return twists wire quickly into a strand that won't unravel. Hardened and tempered.

Stock #	Length	
G. PLR-799.00	9" (230mm)	\$22.55
H. PLR-799.50	6" (150mm)	\$20.45

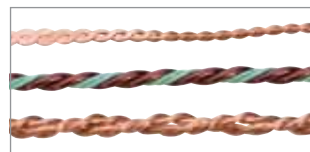

Copper wire twisted
then hammered.

Two wire colors twisted together.

Wire twisted, doubled over
and twisted again.

See our how-to video on the Wire Twisting
Plier at www.eurotool.com

METAL HOLE PUNCH PLIERS

Our newly designed hole punch pliers will punch copper or silver as thick as 18 gauge. With ergonomic handles and tempered replaceable pin, these pliers will save you time and money. Now available in two models: 1.25mm or 1.8mm pin diameter. The pliers are made of thick carbon steel and come with an extra replaceable pin. Additional replacement pins available in packs of five.

Stock #	Description	Length	
A. PLR-133.50	Metal Hole Punch Pliers - 1.8mm	5 1/4" (135mm)	\$14.95
PLR-133.51	Replacement Pins - 1.8mm, Pk/5		\$6.95
PLR-133.60	Metal Hole Punch Pliers - 1.25mm	5 1/4" (135mm)	\$14.95
PLR-133.61	Replacement Pins - 1.25mm, Pk/5		\$6.95

HOLE-PUNCHING PLIERS

Our hole punch pliers are made of the finest steel for long life and ease of use. We've gone high tech with this model, bringing the cost down and the quality up. Unlike most hole punch pliers, this one offers a 1.5mm punch with precise clearance for a clean cut. Gentle return springs and EURO GRIP handles for comfort.

Stock #	Length	
B. PLR-138.05	5 3/4" (145mm)	\$10.95

PARALLEL HOLE PUNCH PLIERS

Developed by EURO TOOL, the Parallel Hole Punch Pliers give the user leverage and assurance that the pin goes straight through the hole every time for a clean shearing action. This guarantees a clean hole without rough edges or burrs in sheet stock up to 18 gauge. Pins are replaceable.



Stock #	Description	Length	
C. PLR-868.00	Parallel Hole Punch Pliers	5 1/2" (140mm)	\$26.95
PLR-868.01	Replacement Pins - 1.5mm, pk/5		\$7.95

HOLE-PUNCHING PLIERS

Punch 2mm holes in leather or plastic bands with this handy plier.

Stock #	Length	
D. PLR-138.00	5 1/2" (140mm)	\$10.85

LEATHER PUNCH PLIERS

Unique tool, made of stainless steel, features a hardened rotating wheel which allows the user to cut hole sizes from 0.80 to 2.0mm. Great for leather and other soft materials, they are box-jointed with a return spring for ease of handling.



Stock #	Length	
E. PLR-139.00	6 1/4" (160mm)	\$24.95

RING-CUTTING PLIERS

This tool is made to cut with a minimum of discomfort and effort. The blade is hardened alloy and completely enclosed. Quality-made in France.

Stock #	Description	Length	
F. PLR-814.00	Ring-Cutting Plier	4 1/2" (115mm)	\$38.80
PLR-814.01	Replacement Blade		\$13.95

LARGE RING CUTTING PLIERS

Large ring cutting pliers are a new addition and easier to use than traditional ring cutting pliers. Made entirely of stainless steel, the handles are gently curved. The turning handle is large and the blade is a generous 1 3/16" (30.30mm) in diameter for easy cutting. Blades are made of tempered steel and are easily replaced.

Stock #	Description	Length	
G. PLR-815.00	Large Ring Cutting Plier	6 1/2" (170mm)	\$19.95
PLR-815.05	Replacement Blade		\$5.95

EUROPOWER RING CUTTER

A great enhancement to our PLR-814.00! Includes the traditional "key" which enables the user to turn the blades by hand, plus a hexagonal shaped key for use with a battery powered screwdriver. Simply unscrew the retainer nut from the standard butterfly key and replace with the hexagonal key - Bingo - it's ready to use with a power screwdriver. Made of the finest quality steel, this cutter will last for years.

Stock #	Description	
H. PLR-814.15	Europower Ring Cutter	\$37.95
PLR-814.01	Replacement Blade	\$13.95

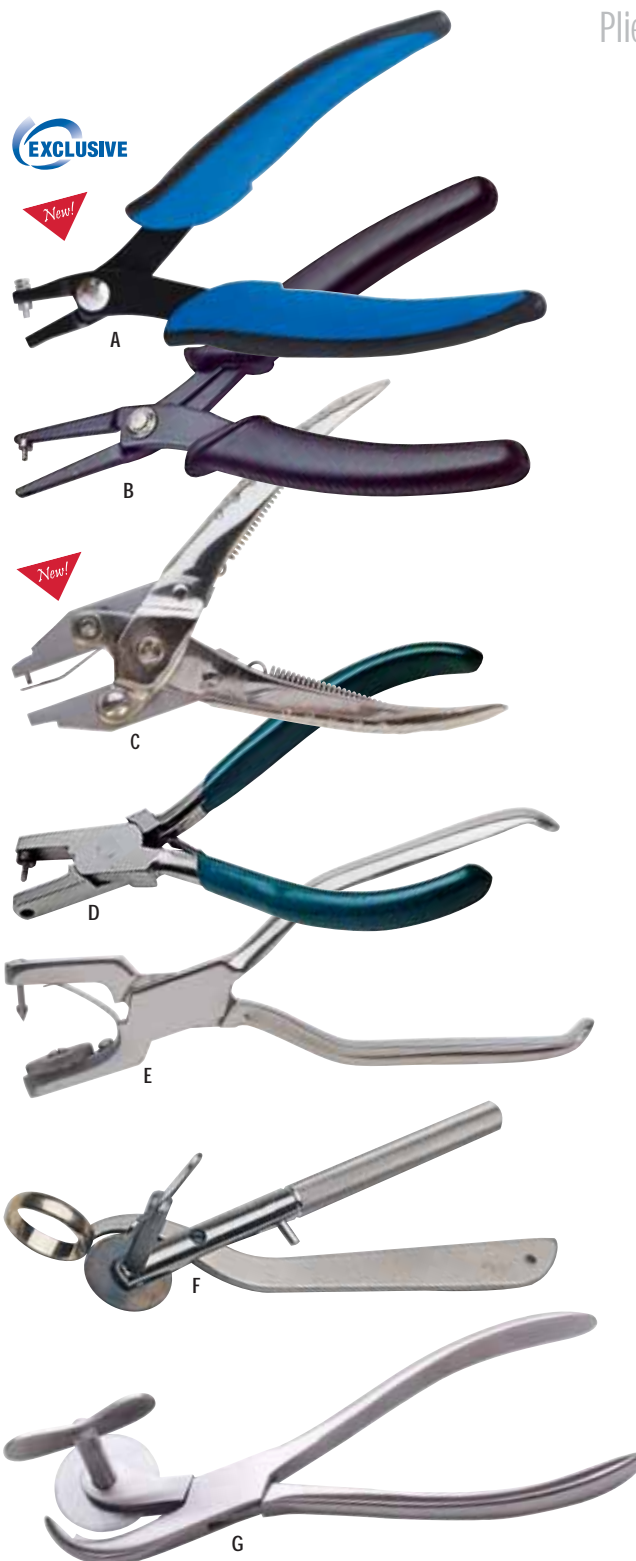

Can be used manually or with a cordless screwdriver. Screwdriver not included.

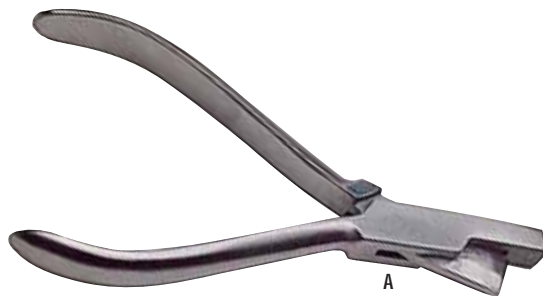

A

WATCH STRAP NOTCHING PLIERS

Sometimes referred to as a “Gucci” plier, this cutter is for notching watch straps, eliminating excess inventory. Made of stainless steel, cuts notches 2mm wide.

Stock #	Length	
A. PLR-816.00	5" (125mm)	\$12.30



B

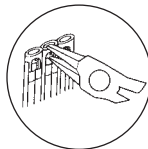

CLIP SPRING REMOVING PLIERS

An essential tool for adjusting the length of Seiko style watch bands. The flat jaw rests atop the link, and the pointed tip fits under the clip spring. By gently squeezing, the clip spring pops up and can be easily removed to allow for sizing.

Stock #	Length	
B. PLR-136.01	5 1/2" (140mm)	\$9.95



C

CLIP SPRING REMOVING PLIERS - GERMAN

Made in Germany, this plier is the best quality pin remover on the market for watch bracelets. The round nose fits snugly into the recessed pin to snap it out cleanly.

Stock #	Length	
C. PLR-136.05	5" (125mm)	\$17.60

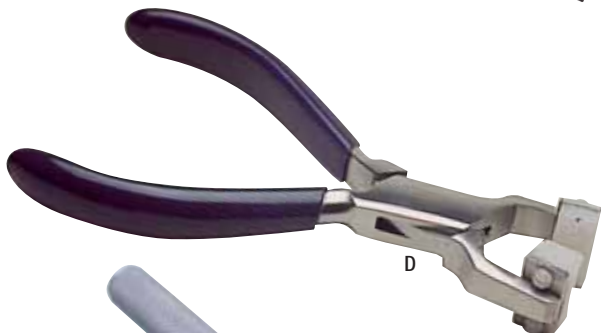

D

SPRING BAR BENDING PLIERS

This unique and practical spring bar bending plier delicately shapes spring bars of any size to the proper shape. Jaws are made of high impact nylon and grooved to hold the spring bar in place while bending. Stainless steel box-joint construction. Replacement jaws sold by the pair.

Stock #	Description	Length	
D. PLR-845.00	Spring Bar Bending Plier	5" (125mm)	\$14.95
PLR-845.05	Replacement Jaws (pair)		\$4.15



E

BRACELET PIN REMOVING PLIERS

This unique device is perfect for removing stubborn watch bracelet pins. Designed so that the “punch pin” will move perfectly parallel, it also features knurled jaws for pulling out the bracelet pin once it is exposed. The body is made of stainless steel. Hardened pins are replaceable and the unit comes with two pins for your convenience, .80mm and 1.00mm.

Stock #	Description	Size	
E. PLR-140.00	Bracelet Pin Removing Pliers	6" (150mm)	\$19.95
PLR-140.05	Replacement Pin for PLR-140.00	0.80mm	\$1.50
PLR-140.06	Replacement Pin for PLR-140.00	1.00mm	\$1.50

CASE-CLOSING PLIERS

One of our most popular items, the optical pliers work very well for closing snap-back cases where extra leverage is needed. Jaws are rubber-lined to eliminate scratching or breaking crystals.

Stock #	Length	
F. PLR-820.00	7 3/4" (195mm)	\$15.95



F

See our complete line of watch case closers on page 223–224.

MOLD OPENING PLIERS

Reverse-action mold opening pliers have jaws that open when the handles are squeezed. Features a duck-bill type jaw which comes to a point and is perfect for opening molds or can be used for other opening applications where a minimum of damage is necessary. Pliers are 5 3/4" (145mm) long and feature PVC grips and a coil spring. Made in Germany.



Stock #	Length	
A. PLR-728.00	5 3/4" (145mm)	\$28.30

BOW OPENING PLIERS

For opening bows or stretching bows and links. Reverse action pliers enable the jaws to open when the handles are squeezed. Our pliers feature ridges to hold the bow in place, gentle coil spring and PVC grips. Made in Germany of chrome vanadium steel.



Stock #	Length	
B. PLR-729.00	5 1/2" (140mm)	\$31.05

ULTRA ERGO BOW OPENING PLIERS

Handy with a better ergonomical design when trying to open stubborn bows or loops. Great for work with wire and chain maille. Made of high grade stainless steel, box-jointed with comfortable, ergonomic handles for greater leverage and comfort.



Stock #	Length	
C. PLR-729.05	6" (150mm)	\$12.95

BOW-CLOSING PLIER with BRASS JAW

Great for rounding and closing small rings and bracelets without marring the outside surface. You will be amazed at the ease with which you can gently shape and round wire, bend ring blanks and shanks to the shape desired, all with a simple hand tool. Sturdy box-joint construction, stainless steel, with no-mar brass jaw.

Stock #	Description	Length	
D. PLR-731.00	German Model	5 1/2" (140mm)	\$56.50
PLR-731.50	Economy Model	5 1/2" (140mm)	\$19.95

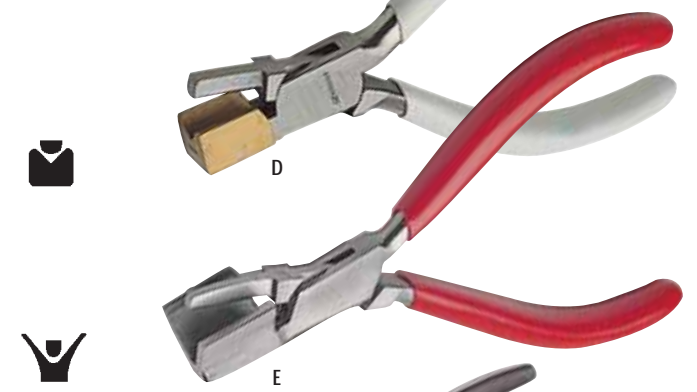
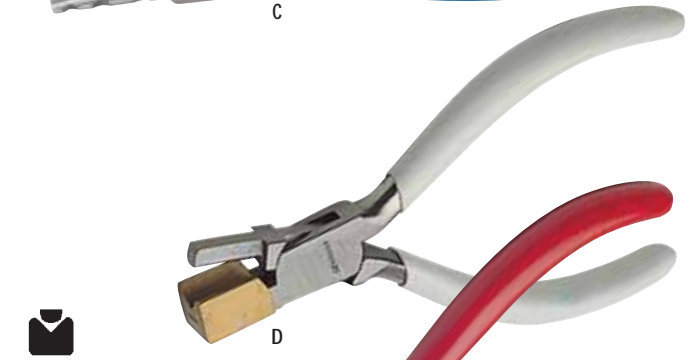
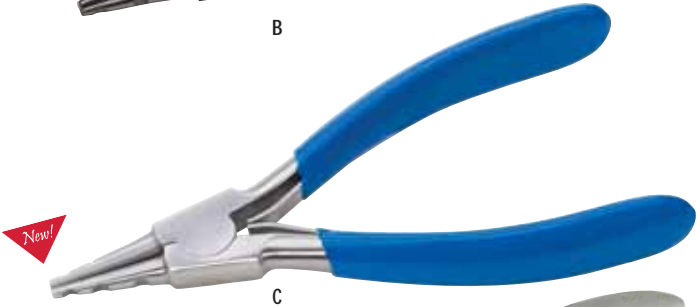
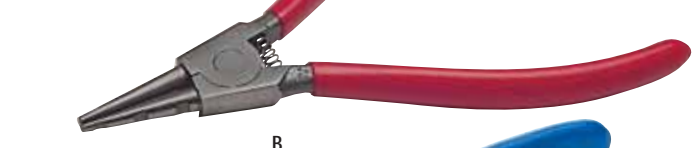

SMALL BOW-CLOSING PLIERS

Handy for reshaping small rings and bows. Our small bow-closing pliers offer a smooth stainless steel jaw, box-joint construction and cushion grips.

Stock #	Length	
E. PLR-732.00	5 1/4" (135mm)	\$16.95

PENDANT PLIERS

For opening and closing links, rings and even pocket watch bows. Slotted jaw and hook make it easy for the user to grab anything that needs to be expanded. The brass jaw can be used to round rings and other objects. Pliers are just under 7" long for maximum leverage. Made in Germany.



Stock #	Length	
F. PLR-733.00	6 7/8" (175mm)	\$56.95

SOLDER CUTTING PLIERS

Our solder cutting pliers offer two ways to cut. A EURO TOOL exclusive, it cuts sheet solder in 1/16" (1.60mm) squares or wire solder up to 18 gauge in 1/16" (1.60mm) lengths. Fast and easy, but it does not flip solder pieces and gives you the same amount every time.



Stock #	Length	
G. PLR-818.00	5 1/2" (140mm)	\$16.65





PARALLEL ACTION PLIERS

Quality-made pliers with unique parallel action design allows the jaws to open and close parallel to each other. This feature provides a vise-like grip on your work and gives the user greater leverage than conventional pliers. Made in England.

Stock #	Description	Length	
A. PLR-850.00	Chain Nose - Smooth Jaws	5" (125mm)	\$32.95
B. PLR-855.00	Flat Nose - Serrated Jaws w/V-Slot	5" (125mm)	\$21.00
C. PLR-856.00	Flat Nose - Smooth Jaws	5" (125mm)	\$24.10

D. PARALLEL PLIERS

Excellent quality at an affordable price! Heads and jaws are made of high grade tool steel for years of use. Available with chain, flat, flat serrated or flat brass jaws, compound pliers give the user a superior hold with less fatigue. The flat nose with soft brass jaws protects sheet stock and softer metals from marring. Give ours a try, you'll agree that they make work a lot easier!

Stock #	Description	Length	
D. PLR-860.00	Chain	5 1/2" (140mm)	\$18.50
PLR-866.00	Flat	5 1/2" (140mm)	\$18.00
PLR-865.00	Flat, Serrated	5 1/2" (140mm)	\$18.20
E. PLR-867.00	Flat, Brass Lined Jaw	5 1/2" (140mm)	\$29.95

Great Value!



C.H.P. MILANO ITALIAN FLUSH CUTTER

New Italian cutter, made of high grade tool steel is perfect for lighter jobs where a flush cut is essential. This cutter, made in Italy features a blackened non-glare head, return spring and high friction ergonomic grips. Maximum cut is 16 gauge 1.5mm copper wire.

Stock #	Length	
F. PLR-487.00	5 1/2" (140mm)	\$10.95

C.H.P. MILANO SMALL SPRUE CUTTER ITALIAN – FLUSH CUT

This 6 3/4" jumbo version is made of thicker high grade tool steel for heavier cutting jobs. Excellent for small sprues, it will cut up to 14 gauge (2.5mm) soft wire. The jaws give the user a nice flush cut, and the longer handles create excellent leverage. Made in Italy.

Stock #	Length	
G. PLR-488.00	6 1/4" (160mm)	\$21.95

C.H.P. MILANO ANGLED FLUSH CUTTER

Precision Italian-made cutter with 48° angled head to reach tight places. Made of hardened carbon steel ground to exacting specifications. Features a blackened non-glare head, return springs and high friction ergonomic grips. Maximum cut is 22 gauge copper wire.

Stock #	Length	
H. PLR-489.00	6 1/4" (160mm)	\$14.95

C.H.P. MILANO ITALIAN SHEAR

Made of high grade tool steel this Italian shear has soft friction grips with ergonomic handles and 3/4" (18mm) super sharp blade for precision cutting. This shear is excellent for cutting solder and other small jobs. Its overall length of 5 3/4" gives the user good leverage.

Stock #	Length	
I. SHR-630.00	5 3/4" (145mm)	\$25.95



Xuron cutters are made in the USA specifically for precision applications. Xuron uses modern technology and engineering which allows small cutters to do the job that would normally require much larger cutters. Made of induction hardened tool steel with gentle return springs and comfort grips to assure hours of fatigue-free use.

FLUSH CUT PRONG CUTTER

Excellent shear action cutter especially suited for prong cutting.

- End cut configuration.
- Shear action for 90° cut and long life.
- Made of hardened, high-grade tool steel.

Stock #	Length	
A. PLR-463.50	4 $\frac{5}{8}$ " (118mm)	\$22.95

FLUSH CUT WIRE CUTTERS

For wire or heavy metal strands where you don't want to ruin your normal cutters. Available with thin (beveled) or standard jaws.

- Shear action means a smooth flush cut on both sides.
- 90° cutting edges dull less than conventional cutters.

Stock #	Description	Length	
B. PLR-469.10	Standard Jaw	4 $\frac{3}{4}$ " (120mm)	\$16.45
C. PLR-469.11	Thin (Beveled) Jaw	4 $\frac{3}{4}$ " (120mm)	\$19.45



TAPERED FLUSH CUTTER

The tapered head design on this cutter allows for improved access in tight areas and added precision. Shear action means a smooth flush cut. Made of tough alloy steel.

Stock #	Length	
D. PLR-469.20	5" (125mm)	\$24.45

MAXI SHEAR FLUSH CUTTER 2175

Maxi Shear is a full flush cutter with shear action blades, which barely pass as they cut so not to dull. Made of high-grade carbon steel with PVC grade carbon steel, the Maxi Shear will cut soft wire up to 14 gauge (1.6mm/0.64").

Stock #	Length	
E. PLR-467.50	6" (150 mm)	\$16.15

HEAVY DUTY WIRE SHEAR

Our shear is made specifically to cut gold or silver wire up to 12 gauge and hard wire up to 18 gauge. With maximum leverage and ergonomic design, this cutter uses a 90° shear action to assure a flush cut on both sides of the wire. Made of the highest grade tool steel with return springs, ideal for cutting memory wire.

Stock #	Length	
F. PLR-460.00	5 $\frac{1}{2}$ " (140mm)	\$20.30

RING SHANK CUTTER

With one jaw flat, and the other curved to conform to most rings, this cutter for ring shanks 2.5mm or less will give the user a clean, right angle cut so both sides can be easily rejoined. Sweeping up gold or silver filings will not be necessary.

Stock #	Length	
G. PLR-461.00	5 $\frac{1}{2}$ " (140mm)	\$19.85

HARD WIRE SHEAR ACTION CUTTER

Our hard wire shear is the perfect cutter for hard wire of 0.50mm (24 gauge) or soft wire up to 2mm (12 gauge). Because of its shear type action this cutter will not nick or dull like ordinary cutters. Save those expensive flush cutters for needed jobs by using this cutter for the hard stuff. It features black oxide finish, cushion grips, return spring and is economically priced.

Stock #	Length	
H. PLR-461.50	5" (125mm)	\$13.75

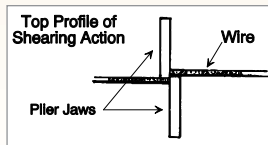

"Shear Action" cutters (F, G, H) for hard wire leave wire 90° on both ends after cut.



High leverage shear action cuts memory wire cleanly leaving both ends blunt.



Great Value!

This 3 1/2" flush sidecutter is perfect to take anywhere!

Recommended for multi-strand beading wire.



ULTRA FINE POINT, ULTRA FLUSH CUTTER

Our new addition gives the user an effective and economical tool for cutting multi-strand beading wire as well as headpins and other softer wires. At this price anyone can own the perfect cutter for a wide variety of tasks. Note: This cutter offers an extra-fine point to reach hard-to-get places – you're going to love it!

Stock #	Description	Length	
A. PLR-474.00	Flush	5" (125 mm)	\$9.95

SUPER MICRO CUTTER

Our Super Micro Cutter is a great value in a flush sidecutter. Made of hardened tool steel and induction hardened jaws, the cutting edge is relieved for a clean cut with a fine point for tight work. With comfort grips and a steel spring, this cutter is perfect for those smaller jobs, and reasonably priced.

Stock #	Description	Length	
B. PLR-471.00	Flush	4 3/4" (120mm)	\$12.95

BEAD CORD NIPPERS

Two full flush bead nippers offer you the choice of our original SHR-170.00 or SHR-175.00 with a more ergonomic handle. Excellent for all soft wire up to 20 gauge and beading wire too!

Stock #	Description	Length	
C. SHR-170.00	Bead Nipper	5" (125mm)	\$6.15
D. SHR-175.00	Traditional Bead Nipper	5" (125mm)	\$5.10

E

EXTRA SMALL FLUSH SIDECUTTER

If you need a flush cutter that you can carry anywhere, this 3 1/2" "small wonder" is perfect for you. The jaws are induction hardened, and totally flush. This cutter also features black comfort grips and a return spring. It is perfect for multi-strand wire, bead pins and soft colored wire. Take this economical cutter anywhere!

Stock #	Description	Length	
E. PLR-473.00	Flush	3 1/2" (90 mm)	\$5.95

FLUSH or SEMI-FLUSH PRECISION SIDECUTTERS

These cutters, made in Europe, offer the perfect answer to crafts people who need strength in a precision sidecutter. Jaws pass one another ever so slightly but do not touch, and therefore do not dull as quickly as conventional cutters. Adding a safety clip to our precision European cutters keeps wire or other materials from flying when cut, minimizing waste. Now these great cutters are available in ultra-flush or semi-flush, with or without safety clip, as well as an extra hard jaw for extended life. All with a smooth return spring and ergonomic cushion grip handles.

Stock #	Description	Length	
F. PLR-470.00	Ultra-Flush	5" (125mm)	\$25.33
G. PLR-470.10	Semi-Flush	5" (125mm)	\$25.87
H. PLR-470.00L	Ultra-Flush w/ Safety Clip	5" (125mm)	\$26.62
I. PLR-470.10L	Semi-Flush w/ Safety Clip	5" (125mm)	\$26.95
J. PLR-470.50	Extra Hard Jaw, Ultra-Flush	5" (125mm)	\$27.92



FORME D'ART SIDECUTTER

Value-engineered and perfect where a fine point, flush cutter is needed for precision work. Rust free, hardened stainless steel with ergonomically designed handles for greater comfort. Lap-joint construction with removable coil spring.

Stock #	Description	Length	
A. PLR-515.00	Sidescutter, Flush	4 $\frac{3}{4}$ " (120mm)	\$6.85

BARRACUDA HARDWIRE SIDECUTTER

Made of a new tool steel alloy, this 4 $\frac{1}{2}$ " sidescutter has a Rockwell hardness at the cutting edge of 61–63. It will cut hard-wire from 0.40mm (26 gauge), and will last for years with non-ferrous wire. Excellent for bead stringing and wire wrapping. Edge is flush on the Barracuda. Handles are cushion grip, with double-leaf springs and box-joint construction. Made in Germany.

Stock #	Description	Length	
B. PLR-116.00	Flush	4 $\frac{1}{2}$ " (115mm)	\$27.85

5" FLUSH DIAGONAL CUTTER

For flush cutting, this sidescutter features a micro-bevel and coil spring. Jaws are induction hardened to Rockwell 57. Made of high grade tool steel, this cutter is a quality, economical tool. Good for $\frac{1}{2}$ hard wire up to 14; soft up to 16. You can't beat this cutter for the price.

Stock #	Description	Length	
C. PLR-766.00	Flush	5" (125mm)	\$10.95

HARD-WIRE CUTTER

Extra-hard, semi-flush 5" (125mm) sidescutter for cutting hard wire. This German-made, lap-joint plier is the ultimate in hardness because it is pre-tempered and induction-hardened. A great value.

Stock #	Description	Length	
D. PLR-765.00	Semi-Flush	5" (125mm)	\$25.85

FLUSH END CUTTER

Made of the finest German steel and induction-hardened to a Rockwell hardness of 58, this 5" (125mm) flush end cutter is unequalled for cutting small sprues as closely as possible. Because it is an end cutter it offers excellent leverage, and this particular cutter is the best available. But, as with any flush cutter, it should not be used to cut hard wire. A must for every shop.

Stock #	Description	Length	
E. PLR-784.00	Flush	5" (125mm)	\$36.35

CARBIDE JAW/MEMORY WIRE CUTTERS

Carbide cutters are made particularly for hard wire and feature carbide jaw inserts for maximum hardness. Made in the same method as cutters used by orthodontists for hard wire, cutters available in a choice of grips and all have gentle return springs. You can get years of service from this tool, which is almost indestructible when used properly.

Stock #	Handle	Length	
F. PLR-781.00	PVC Cushion Grip	5 $\frac{1}{2}$ " (140mm)	\$26.95
PLR-781.50	Soft Grip PVC	4 $\frac{1}{4}$ " (110mm)	\$21.95
G. PLR-275.80	Ultra Ergo	5 $\frac{3}{4}$ " (145mm)	\$19.95
H. PLR-255.80G	Glitter	4 $\frac{1}{2}$ " (115mm)	\$19.95

FULL FLUSH CUTTER

Our German cutter specifically designed for multi-strand beading wire is full-flush with jaws induction hardened to 60-62 Rockwell. Used properly this degree of hardness assures a clean cut, time after time. Cutting edges are precisely aligned and the black oxide non-glare head has "relieved" design for reaching into tight areas. This quality German cutter also features double-leaf springs and yellow PVC handles. Use on flexible beading wire and soft wire only.

Stock #	Description	Length	
I. PLR-477.00	Flush Cutter	4 $\frac{1}{2}$ " (115mm)	\$26.95
J. PLR-477.50	Flush Cutter, Pointed Jaw	4 $\frac{1}{2}$ " (115mm)	\$27.75



*Carbide jaws
for maximum
hardness.*



A

LONG NOSE PLIER with SERRATED JAWS and CUTTER

Heavy duty 6 $\frac{1}{2}$ " (165mm) plier which offers good quality at a very reasonable price. Features cushioned-grip handles, serrated jaws and a sidecutter.

Stock #	Length	
A. PLR-665.00	6 $\frac{1}{2}$ " (165mm)	\$5.30

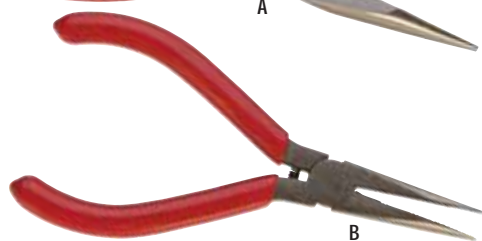

B

LONG NOSE PLIERS with CUTTER

Extra-handy pliers which incorporates cushioned grips, coil springs and long nose jaws with a cutter. Drop-forged alloy steel guarantees user satisfaction. Available with serrated or smooth jaws.

Stock #	Description	Length	
B. PLR-660.00	Serrated Jaws	5" (125mm)	\$4.80
PLR-661.00	Smooth Jaws	5" (125mm)	\$5.95

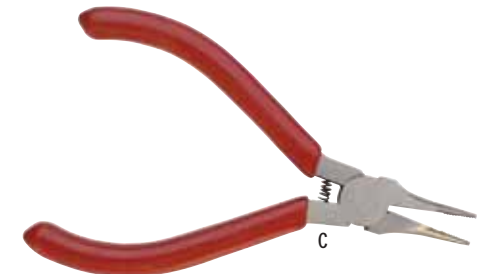

C

NEEDLE NOSE SERRATED PLIERS

Inexpensive, 4 $\frac{1}{2}$ " (115mm) long and serrated for pulling and bending wire. Used primarily for electronics work but good for a variety of applications.

Stock #	Length	
C. PLR-666.00	4 $\frac{1}{2}$ " (115mm)	\$4.80

Great Value;
Great Performance!



New!

D

END CUTTER

A powerful, yet economical end cutter that really holds up for the tough jobs. Make close, sharp cuts on wire and sprues. Maximum cut of 14 ga.

Stock #	Length	
D. PLR-958.20	4" (100mm)	\$10.95

**SIDECUTTERS – ECONOMY / UTILITY**

4 $\frac{1}{2}$ " (115mm) sidecutter is induction hardened and has a gentle, coil-return spring. With semi-flush jaws, it is excellent for fine cutting. For larger jobs where strength and leverage are important, try our 6" (150mm) sidecutter with cushioned grips.

Stock #	Length	
E. PLR-685.00	4 $\frac{1}{2}$ " (115mm)	\$4.90
PLR-689.00	6" (150mm)	\$4.90



E

CUTTERS FOR PLASTIC SPRUES

These sprue cutters, which are totally flush, were manufactured to cut plastic sprues. They can also flush cut very small and softer wires. Each features PVC grips, and a coil spring return for ease of use.

Stock #	Length	
F. PLR-794.55	6" (150mm)	\$8.90
PLR-794.57	7 $\frac{1}{2}$ " (190mm)	\$10.50



F



G

COMPOUND DIAGONAL CUTTER

This 5 $\frac{3}{4}$ " diagonal cutter features compound action. With black anodized head, and stainless steel handles, it is a quality yet economical version of the famous model made in England. Excellent for hard wire where leverage is necessary.

Stock #	Length	
G. PLR-762.00	5 $\frac{3}{4}$ " (145mm)	\$16.95

COMPOUND SPRUE CUTTER

This German-made cutter can take a big bite without marking or denting and is semi-flush so it leaves very little metal to remove. Compound lever action multiplies your efforts helping to eliminate fatigue. Handles are premolded for comfort.

Stock #	Length	
H. PLR-760.00	7 $\frac{1}{2}$ " (190mm)	\$41.95



H

LINDSTROM HEAVY-DUTY CUTTER 8180TRX

Lindstrom introduces a large cutter in the RX series for use on copper wire and hard wire applications. The TRX8180 heavy-duty cutter can handle solid copper wire and hard steel wire from 24 gauge (0.5 mm/0.02 inch) up to 9 gauge (2.75 mm/0.11 inch) This powerhouse cutter utilizes the new "progressive cut" beveled edges- suited for soft wire at the tip and hard wire closer to the jaw - for versatile operation. Micro-bevel cutting edges hardened to 63-65 for durable performance.

Stock #	Length	
A. PLR-8180TRX	8 1/4" (210mm)	\$62.95

**POWER MAX CUTTERS**

Ergonomic compound cutters that offer the finest in compound leverage construction at an affordable price. Leverage combined with an induction-hardened, high-grade steel jaw allows for extra close cutting. The handles are shaped to be ergonomically efficient and to prevent fatigue and possible injuries, which can sometimes accompany hours of cutting. Power Max cutters available with a semi-flush or flush bevel. Cuts up to 12 gauge. Great for thicker copper.

Stock #	Description	Length	
B. PLR-790.00	Semi-Flush	6 1/2" (165mm)	\$32.25
PLR-791.00	Flush	6 1/2" (165mm)	\$33.50

**ULTRA POWER MAX CUTTER**

This compound cutter made in Italy features compound construction with hardened tool steel jaws and a semi-flush cut. The head is made of chrome vanadium steel. This is the finest large compound cutter we've seen. Excellent for sprues and thick wire. Cuts soft wire up to 0.11" (3.0mm) and hard wire up to 0.039" (1.0mm).

Stock #	Length	
C. PLR-795.00	9 1/2" (240mm)	\$99.95

**"HIT" SIDECUTTER**

Miniature bolt cutter for cutting sprues, shanks and thick wire. Cuts hard wire up to 1.0mm in diameter due to the force of its compound action and jaws which are hardened chromium steel. This cutter saves the user hand strain and fatigue. Made in Japan. Economy version will give the user an alternative where less usage is required.

Stock #	Length	
D. PLR-796.00	8 1/2" (215mm)	\$24.65

**"HIT" ANGLED CUTTER**

For larger sprues and wire, which you cannot cut with normal sidecutters, this cutter made of hardened carbon tool steel, has angled jaws for getting into tighter places. Handle grips are injection molded for a firm grip. This is definitely the cutter to use for those tougher jobs. Made in Japan.

Stock #	Length	
E. PLR-796.10	8 1/2" (215mm)	\$22.75

**"HIT" END CUTTER**

For maximum leverage when cutting sprues and wire, this premium quality end cutter will do the job. Ergonomic designed comfort grips to eliminate fatigue. Made in Japan.

Stock #	Length	
F. PLR-796.20	8 1/2" (215mm)	\$24.65

**COMPOUND SPRUE/MEMORY WIRE CUTTER**

The new EURO TOOL compound cutter is a full 8 1/4" (210mm) long for excellent leverage. The jaws are hardened tool steel to cut memory wire up to 16 gauge, or sprues up to 1/8". Jaw length is 5/8" (14mm). This cutter is economical, but don't let its price fool you.

Stock #	Length	
G. PLR-796.80	8 1/4" (210mm)	\$13.95



**ADJUSTABLE PLIERS**

The multi-grooved handles adjust for various jobs, making this tool great for holding and turning round objects where other tools won't work.

Stock #	Length	
A. PLR-690.00	7 1/2" (190mm)	\$5.90

**CRIMPING TOOL**

For cutting, stripping and crimping eyelets onto electrical wire. Good for strands or single wire of most gauges.

Stock #	Length	
B. PLR-693.00	8 1/2" (215mm)	\$4.10

**SLIP JOINT PLIERS**

Slip Joint Pliers with wire cutters are handy for a variety of jobs. Ours are economical but made from drop-forged steel with a nickel plating to prevent rust. Slip joint allows jaws to spread for holding large diameter objects.

Stock #	Length	
C. PLR-691.00	6 1/2" (165mm)	\$3.95



We suggest that if you want to offer sets with a good, inexpensive cutter, you consider our PLR-766.00 flush sidecutter (catalog page 161).

STUDENT SERIES PLIERS

Our chain, flat and round nose pliers are priced just right for the student or beginner. However, the quality meets EURO TOOL standards for a plier this economical. They are thinline type, 4 3/4" length with blue PVC grips and no springs. All are highly polished stainless steel with box-joints. Economy – yes, but value too. We suggest that if you want to offer sets with a good, inexpensive cutter, you consider our PLR-766.00 flush sidecutter (catalog page 161).

Stock #	Description	Length	
D. PLR-957.00	Chain	4 3/4" (120mm)	\$3.05
E. PLR-957.05	Flat	4 3/4" (120mm)	\$3.05
F. PLR-957.10	Round	4 3/4" (120mm)	\$3.05
PLR-957.98	3 pc Student Plier Set		\$8.95

**ECONOMY DUTY PLIER SET**

Includes chain nose, round nose, flat nose, sidecutter and end cutter.

Stock #	Description	Length	
G. PLR-956.00	Set of 5	5 1/2" (140mm)	\$14.95

USA made Plating Equipment!

BLUE STAR 30 AMP RECTIFIER

This powerful 30 amp rectifier will electro-strip, electro-plate, electro-clean, and electro-form to the highest quality standards. Great for high production. Very heavy duty steel body with precise voltage and amperage meters. The larger rectifier serves a dual purpose because it features outlets for pen plating as well as conventional plating. The user can save work space and be assured of adequate power for either application. Work and Anode leads included. Output: DC 0-15 volts and CD 0-30 AMPS. Unit standard 120 volts. 220 volts available upon request. UL approved to meet or exceed all safety requirements.

Stock #	Description	Weight	
A. PEN-820.00	Rectifier	24 lbs.	\$265.00
B. PEN-821.00	Rectifier/Pen Plater	26 lbs.	\$359.00



RHODIUM PEN PLATING SYSTEM – 3 JAR

Precision voltage adjustment gives high quality production. Three different color-coded cups allow ample space for all solutions. Cabinet holds three cups and four pens. Includes three solution jars, one pen, and alligator clamp. Machine comes standard in 120 volt. 220 volt available upon request. UL approved to meet or exceed all safety requirements.

Stock #		
C. PEN-813.00		\$185.00



BLUE STAR RHODIUM PEN PLATING SYSTEM

Precise voltage adjusting enhances quality and production. Features an all steel cabinet, fused for safety against accidental damage, and an on/off indicator light. Includes one solution jar, one pen, and alligator clamp. 120 volts, 220 volts available upon request. UL approved to meet or exceed all safety requirements.

Stock #		
D. PEN-810.00		\$155.00



PEN PLATING MOUNT

Designed to assist holding your piece while pen plating. Two sets of clamps are sent with the unit: an inner clamp to hold rings and an outer clamp to hold coins. Work is held steady, keeping your hands free and the object clean. Unit fits all models of pen plating systems. Simply connect the negative terminal to the work terminal on the machine and begin to plate your piece.

Stock #		
E. PEN-825.00		\$29.95



ALLIGATOR CLAMP AND LEAD

Used as the negative or work lead for most plating systems.

Stock #		
F. PEN-810.01		\$6.95



PEN PLATING HANDLES

Our standard handle fits most plating systems. Very durable and long lasting. Fits most plating systems and preferred by professionals.

Stock #	Description	
G. PEN-822.00	Standard Plating Pen	\$29.95
H. PEN-823.00	Palladium Plating Pen for Platinum	\$79.95



PEN PLATING TIPS

Premium quality, exceptional value and made from the finest felt available. We offer both standard and fine tips for doing precise detail work.



Stock #	Description	
I. PEN-670.00	Standard Bullet	\$0.95
J. PEN-670.50	Fine Tip	\$0.95



Available in 1" or 1 1/2" with three grits to choose from.

CHAMOIS HALF-ROUND BUFF STICK

Not new, just improved. Made of tapered half round hardwood and covered in quality chamois, this buff stick is great for the inside of rings and other hard to reach areas, while the flat side is available for other surfaces. Sold in a pack of 3.

Stock #	Description	
A. BUF-749.03	pk/3	\$5.95

SANDING STICKS - HALF-ROUND/ROUND

New from EURO TOOL, Sanding sticks in 6 grits: 6/0, 4/0, 3/0, 2/0, 1 and 2. Tapered, half-round for flat surfaces or full round for inside ring and curved surfaces. Excellent for all precious metals and PMC. Each measures a total of 9 1/4" with a sanding surface of 6" which tapers from 3/4" wide to 5/16" wide at the tip. Flat and round – the best of both worlds.

B. Half-Round	Grit		C. Round	Grit	
BUF-751.03	6/0	\$1.35	BUF-753.03	6/0	\$1.90
BUF-751.05	4/0	\$1.35	BUF-753.05	4/0	\$1.90
BUF-751.10	3/0	\$1.35	BUF-753.10	3/0	\$1.90
BUF-751.15	2/0	\$1.35	BUF-753.15	2/0	\$1.90
BUF-751.25	1	\$1.35	BUF-753.25	1	\$1.90
BUF-751.30	2	\$1.35	BUF-753.30	2	\$1.90
BUF-751.98	Half-Round, Set of Six	\$9.95	BUF-753.98	Round, Set of Six	\$11.40

D. FLAT EMERY STICKS

For sanding precious metals, use our emery paper glued onto wood handles. Each stick is 11" long x 3/4" wide. Grits range from #4/0 (finest) to #4 (coarsest).

Stock #	Grit		Stock #	Grit	
BUF-750.05	4/0	\$1.20	BUF-750.25	1	\$1.20
BUF-750.10	3/0	\$1.20	BUF-750.30	2	\$1.20
BUF-750.15	2/0	\$1.20	BUF-750.35	3	\$1.20
BUF-750.20	0	\$1.20	BUF-750.40	4	\$1.20

E. CARTRIDGE ROLLS

Tested by professional jewelers, we've determined DURO-CAL Cartridge Rolls to be the best available for inside ring finishing and various other applications. Just peel and keep going! Our cartridge rolls outlast the others. All have 1/8" holes and are sold in packages of 25.

Stock #	Grit	Size (length x width)	
ABR-510.01	Fine (180)	1" x 1/2"	\$9.75
ABR-510.02	Medium (100)	1" x 1/2"	\$9.75
ABR-510.03	Coarse (60)	1" x 1/2"	\$9.75
ABR-515.01	Fine (180)	1 1/2" x 1/2"	\$13.60
ABR-515.02	Medium (100)	1 1/2" x 1/2"	\$12.95
ABR-515.03	Coarse (60)	1 1/2" x 1/2"	\$12.95

CARTRIDGE ROLL MANDRELS

Handy and necessary, our cartridge roll mandrels are blackened tool steel. They are tested true and offer the user excellent value. Fits cartridge rolls with 1/8" hole.

Stock #	Description	
F. MAN-400.10	1/8" Shank	\$1.80
MAN-400.20	3/32" Shank	\$1.80

SPLIT MANDRELS

Mandrels with split for sanding papers. Available in straight cylinder or tapered. Sold per dozen.

Stock #	Description	Shank	
G. BRS-278.00	Tapered Split Mandrel	3/32"	\$7.95
H. BRS-278.50	Straight Split Mandrel	3/32"	\$7.95

SANDING MANDRELS

A terrific idea developed by Kate Wolf for sanding and finishing the inside of rings. The larger diameter barrels work more quickly to do a better job. Sizes are 1/4", 3/8" and 1/2" (6.35, 8.9, 12.65mm). Shanks are 3mm on the two smaller ones and 4mm on the larger size. Made of stainless steel, the mandrels are machined true and come with rubber bands to hold the emery paper in place. Available in sets or individually. Shanks are 5/8" (16.50mm) long. Maximum 10,000 RPMs.

Stock #	Description	
MAN-450.00	Set of 3	\$8.95
I. MAN-450.01	1/4" Sanding Mandrel	\$2.50
J. MAN-450.02	3/8" Sanding Mandrel	\$2.80
K. MAN-450.03	1/2" Sanding Mandrel	\$3.50



A. ADALOX BRASS CENTER SANDING DISCS

Adalox brass center snap-on sanding discs feature aluminum oxide on a flexible backing. Excellent for sanding tight places. For use with our BRS-279.00 mandrel. Available in box of 100 with mandrel or master pack of 600 (12 boxes of 50 discs per box).

Bx/100	Bx/600	Diameter	Grit
ABR-155.01 \$9.95	ABR-155.11 \$44.95	1/2"	Fine
ABR-155.02 \$9.95	ABR-155.12 \$44.95	1/2"	Medium
ABR-155.03 \$9.95	ABR-155.13 \$44.95	1/2"	Coarse
ABR-157.01 \$9.95	ABR-157.11 \$44.95	3/4"	Fine
ABR-157.02 \$9.95	ABR-157.12 \$44.95	3/4"	Medium
ABR-157.03 \$9.95	ABR-157.13 \$44.95	3/4"	Coarse
ABR-159.01 \$9.95	ABR-159.11 \$44.95	7/8"	Fine
ABR-159.02 \$9.95	ABR-159.12 \$44.95	7/8"	Medium
ABR-159.03 \$9.95	ABR-159.13 \$44.95	7/8"	Coarse

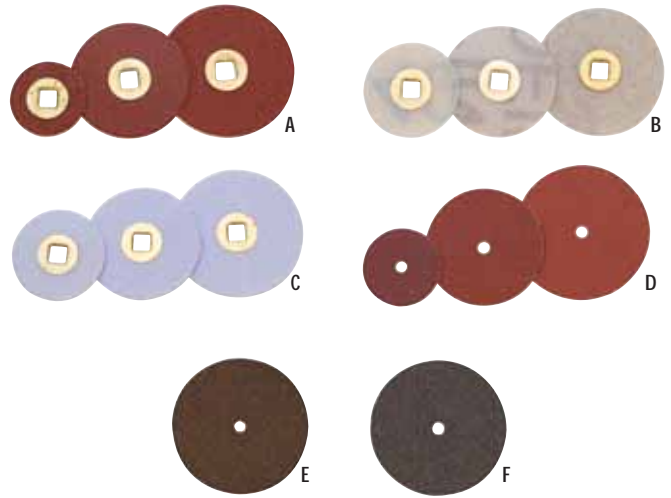

B. MAGNUM SANDING DISCS

Moore Magnum sanding discs are aluminum oxide grit mounted on reinforced plastic for extended life. Excellent for polishing non-precious metals. With snap-on/off brass centers to fit our BRS-279.00 mandrels. Sold in boxes of 100.

Stock #	Diameter	Grit	Qty.	
ABR-175.01	5/8"	Fine	100/bx	\$10.75
ABR-175.02	5/8"	Medium	100/bx	\$10.75
ABR-175.03	5/8"	Coarse	100/bx	\$10.75
ABR-177.01	3/4"	Fine	100/bx	\$10.75
ABR-177.02	3/4"	Medium	100/bx	\$10.75
ABR-177.03	3/4"	Coarse	100/bx	\$10.75
ABR-179.01	7/8"	Fine	100/bx	\$10.75
ABR-179.02	7/8"	Medium	100/bx	\$10.75
ABR-179.03	7/8"	Coarse	100/bx	\$10.75

C. MAGNUM POLISHER

A unique felt polishing disc with brass center especially designed to use with all polishing pastes. Will virtually eliminate spatter. Use with snap on/off mandrel BRS-279.00. Sold in boxes of 100.

Stock #	Diameter	Qty.	
ABR-185.05	5/8"	100/bx	\$19.45
ABR-187.05	3/4"	100/bx	\$19.45
ABR-189.05	7/8"	100/bx	\$19.45

D. ADALOX PINHOLE SANDING DISCS

Feature aluminum oxide and pinhole centers to use with mandrel BRS-275.00. With a flexible backing, pinhole discs are excellent for sanding hard-to-reach areas. Sold in boxes of 100.

Stock #	Diameter	Grit	Qty.	
ABR-165.01	1/2"	Fine	100/bx	\$4.50
ABR-165.02	1/2"	Medium	100/bx	\$4.50
ABR-165.03	1/2"	Coarse	100/bx	\$4.50
ABR-167.01	3/4"	Fine	100/bx	\$4.50
ABR-167.02	3/4"	Medium	100/bx	\$4.50
ABR-167.03	3/4"	Coarse	100/bx	\$4.50
ABR-169.01	7/8"	Fine	100/bx	\$4.50
ABR-169.02	7/8"	Medium	100/bx	\$4.50
ABR-169.03	7/8"	Coarse	100/bx	\$4.50

SEPARATING DISCS

Red hi-speed separating discs made of aluminum oxide.

Stock #	Size	Qty.	
E. ABR-195.00	1" x .025"	100/bx	\$8.25

F. FLAT SEPARATING DISCS

Silicon carbide double cutting separating discs.

Stock #	Size	Qty.	
ABR-196.00	7/8" x .023"	100/bx	\$8.25
ABR-197.30	1" x .023"	100/bx	\$8.25

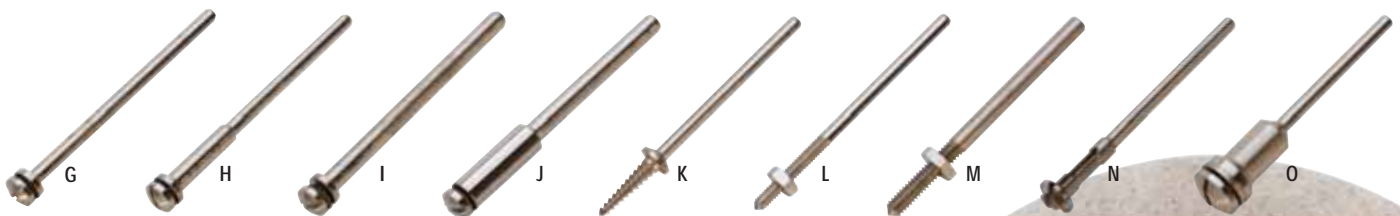

MINIATURE MANDRELS

Good quality, European-made nickel mandrels assure the user satisfaction with every use. Available in both 3/32" and 1/8" shank and a variety of styles. Screw-type mandrels offered in regular and reinforced, work with unmounted wheels, stones, miniature brushes, etc. Threaded mandrels ideal for rubberized abrasives and buffs. All sold by the dozen.

Stock #	Description	Shank	
G. BRS-274.00	Miniature Screw Mandrel, Plain	3/32"	\$8.85
H. BRS-275.00	Miniature Screw Mandrel, Reinforced	3/32"	\$10.10
I. BRS-284.00	Miniature Screw Mandrel, Plain	1/8"	\$8.85
J. BRS-285.00	Miniature Screw Mandrel, Reinforced	1/8"	\$10.10
K. BRS-277.00	Threaded Mandrel, 3/8" Threaded Length	3/32"	\$6.55
L. BRS-277.10	Threaded Mandrel w/ Nut	3/32"	\$9.05
M. BRS-287.10	Threaded Mandrel w/ Nut	1/8"	\$8.95

SNAP-ON MANDREL

Unique easy-on, easy-off mandrel for use with Moore Brass Center Discs. Makes changing sanding discs quick and easy. Sold per piece.

Stock #		
N. BRS-279.00		\$3.85

LARGE, SCREW-TYPE MANDREL

Large nickel-plated screw mandrel with 1/8" shank. 1/4" thread with a threaded length of 3/8". Sold per dozen.

Stock #	Shank	
O. BRS-282.00	1/8"	\$17.90



Ask for the "Blue Discs" by name!

BLUE SANDING DISCS

Zirconia Alumina "Blue Discs" are ideal for use with platinum, but works great on gold and silver as well. Far superior to other abrasives, they will aggressively cut and grind with a uniform precision. Resin-backing for superior durability, Blue Discs will last 2 to 3 times longer than conventional abrasives. Perfectly centered holes eliminate vibration allowing precise cuts. Lubricate with water. Available with pin-hole or brass snap-on centers.

Stock #	Description	Grit	Qty.	
A. POL-392.01	7/8" Pin-Hole	Coarse	Bx/100	\$5.95
POL-392.02	7/8" Pin-Hole	Medium	Bx/100	\$5.95
POL-392.03	7/8" Pin-Hole	Fine	Bx/100	\$5.95
B. POL-394.01	7/8" Brass Center	Coarse	Bx/50	\$5.95
POL-394.02	7/8" Brass Center	Medium	Bx/50	\$5.95
POL-394.03	7/8" Brass Center	Fine	Bx/50	\$5.95

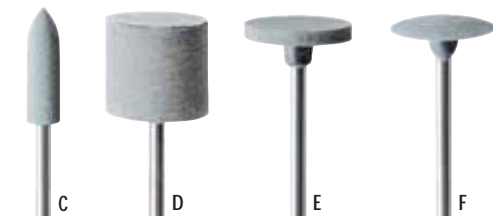

GRAY polishers are medium grit for smoothing.

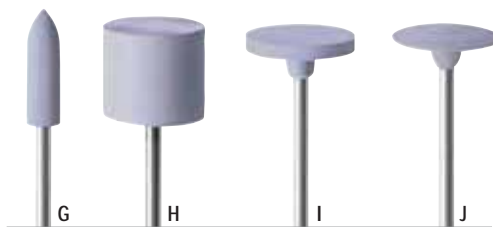

LILAC polishers are fine grit for high lustre polishing.

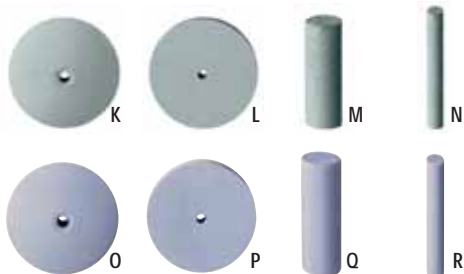

PLATINUM POLISHERS

High performance polishers for use with platinum and titanium. USA made with the highest quality raw materials available, these polishers are offered in two grits. Medium (gray color) grit is for smoothing while fine (lilac color) grit is for high lustre polishing. Operating speed 5,000-10,000 RPM. Sold in dozens or bulk packs.

Mounted Platinum Polishers

	12/pk	100/pk	Shape	Size	Grit
C. POL-370.02	\$22.85	POL-371.02 \$153.60	Bullet	5 x 16mm	Medium (Gray)
D. POL-370.04	\$30.00	POL-371.04 \$212.65	Barrel	14 x 12mm	Medium (Gray)
E. POL-370.08	\$22.85	POL-371.08 \$153.60	Wheel	14.5 x 2mm	Medium (Gray)
F. POL-370.09	\$22.85	POL-371.09 \$153.60	Knife-Edge	14.5 x 2.5mm	Medium (Gray)
G. POL-380.02	\$22.85	POL-381.02 \$153.60	Bullet	5 x 16mm	Fine (Lilac)
H. POL-380.04	\$30.00	POL-381.04 \$212.65	Barrel	14 x 12mm	Fine (Lilac)
I. POL-380.08	\$22.85	POL-381.08 \$153.60	Wheel	14.5 x 2mm	Fine (Lilac)
J. POL-380.09	\$22.85	POL-381.09 \$153.60	Knife-Edge	14.5 x 2.5mm	Fine (Lilac)

Unmounted Platinum Polishers

	12/pk	100/pk	Shape	Size	Grit
K. POL-390.20	\$9.40	POL-391.20 \$61.30	Knife-Edge	22 x 3.5mm	Medium (Gray)
L. POL-390.21	\$9.40	POL-391.21 \$61.30	Wheel	22 x 3mm	Medium (Gray)
M. POL-390.22	\$9.40	POL-391.22 \$61.30	Cylinder	7 x 20mm	Medium (Gray)
N. POL-390.23	\$9.40	POL-391.23 \$61.30	Narrow Cylinder	3 x 23mm	Medium (Gray)
O. POL-390.30	\$9.40	POL-391.30 \$61.30	Knife-Edge	22 x 3.5mm	Fine (Lilac)
P. POL-390.31	\$9.40	POL-391.31 \$61.30	Wheel	22 x 3mm	Fine (Lilac)
Q. POL-390.32	\$9.40	POL-391.32 \$61.30	Cylinder	7 x 20mm	Fine (Lilac)
R. POL-390.33	\$9.40	POL-391.33 \$61.30	Narrow Cylinder	3 x 23mm	Fine (Lilac)

AIRFLEX WHEELS

Square edge wheels with uniformly, interspersed air pockets run cooler allowing you to work longer without burning your fingers. Airflex Wheels are excellent for all precious alloys including platinum, titanium and stainless steel. Made of a silicon carbide abrasive combined with a flexible silicone rubber. Maximum speed 5,000 – 10,000RPM.

Stock #	Grit	Diameter	Qty.	
S. POL-400.05	Coarse (Blue)	7/8" x 1/8" (22 x 3mm)	12/pk	\$11.40
T. POL-400.10	Medium (Green)	7/8" x 1/8" (22 x 3mm)	12/pk	\$11.40
U. POL-400.15	Fine (Brown)	7/8" x 1/8" (22 x 3mm)	12/pk	\$11.40

RUBY STONE ABRASIVES

Used for finishing work, our aluminum oxide stones feature 3/32" shanks to fit all standard handpieces. Ruby points work best for quick fine finishing of semi-precious metals. Handy 12-piece assortment comes packaged in a hanging, reusable plastic pouch or a convenient wood stand.

Stock #	Description	
V. ABR-616.00	Set of 12 Ruby Points in Plastic Pouch	\$16.35
Individual Points	(1-12) listed below	\$1.24



- 1) ABR-616.01
- 2) ABR-616.04
- 3) ABR-616.10
- 4) ABR-616.11
- 5) ABR-616.13
- 6) ABR-616.14
- 7) ABR-616.15
- 8) ABR-616.16
- 9) ABR-616.17
- 10) ABR-616.19
- 11) ABR-616.20
- 12) ABR-616.44

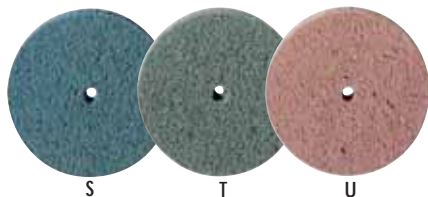

MOUNTED SILICONE POLISHERS

High quality silicone polishers available in three grits for all polishing applications. Sold per package of 12. Made in USA.

Stock #	Description			Qty.	
A. POL-455.00	Set of 12 Silicone Polishers (1-12 listed below)			12	\$15.95
Stock #	Description	Grit	Dia. x Length	Qty.	
1. POL-460.01	Cone	Coarse	5.5 x 15.5mm	12/pk	\$15.60
2. POL-460.03	Barrel	Coarse	6 x 11.5mm	12/pk	\$15.60
3. POL-460.08	Wheel	Coarse	11 x 2mm	12/pk	\$15.60
4. POL-460.09	Knife-Edge	Coarse	11 x 1mm	12/pk	\$15.60
5. POL-470.01	Cone	Fine	5.5 x 15.5mm	12/pk	\$15.60
6. POL-470.03	Barrel	Fine	6 x 11.5mm	12/pk	\$15.60
7. POL-470.08	Wheel	Fine	11 x 2mm	12/pk	\$15.60
8. POL-470.09	Knife-Edge	Fine	11 x 1mm	12/pk	\$15.60
9. POL-480.01	Cone	Extra-Fine	5.5 x 15.5mm	12/pk	\$15.60
10. POL-480.03	Barrel	Extra-Fine	6 x 11.5mm	12/pk	\$15.60
11. POL-480.08	Wheel	Extra-Fine	11 x 2mm	12/pk	\$15.60
12. POL-480.09	Knife-Edge	Extra-Fine	11 x 1mm	12/pk	\$15.60



UNMOUNTED SILICONE POLISHERS

Unmounted abrasive wheels with impregnated silicon carbide are great for deburring, cleaning, smoothing and polishing gold as well as all other metals to a high luster. Recommended maximum 1,000-5,000 RPM. Made in USA.

	12/pk	100/pk	Style	Grit	Size
B. POL-300.10	\$6.15	POL-301.10 \$46.50	Square Edge	Coarse (White)	7/8" x 1/8"
POL-300.20	\$6.15	POL-301.20 \$46.50	Square Edge	Medium (Black)	7/8" x 1/8"
POL-300.30	\$6.15	POL-301.30 \$46.50	Square Edge	Fine (Lt. Blue)	7/8" x 1/8"
POL-300.40	\$6.45	POL-301.40 \$49.90	Square Edge	Extra-Fine (Pink)	7/8" x 1/8"
C. POL-310.10	\$6.15	POL-311.10 \$46.50	Knife-Edge	Coarse (White)	7/8" x 1/8"
POL-310.20	\$6.15	POL-311.20 \$46.50	Knife-Edge	Medium (Black)	7/8" x 1/8"
POL-310.30	\$6.15	POL-311.30 \$46.50	Knife-Edge	Fine (Lt. Blue)	7/8" x 1/8"
POL-310.40	\$6.45	POL-311.40 \$49.90	Knife-Edge	Extra-Fine (Pink)	7/8" x 1/8"
D. POL-320.10	\$6.15	POL-321.10 \$46.50	Cylinder	Coarse (White)	13/16" x 1/4"
POL-320.20	\$6.15	POL-321.20 \$46.50	Cylinder	Medium (Black)	13/16" x 1/4"
POL-320.30	\$6.15	POL-321.30 \$46.50	Cylinder	Fine (Lt. Blue)	13/16" x 1/4"
POL-320.40	\$6.45	POL-321.40 \$49.90	Cylinder	Extra-Fine (Pink)	13/16" x 1/4"
E. POL-330.10	\$6.15	POL-331.10 \$46.50	Bullet	Coarse (White)	1" x 1/4"
POL-330.20	\$6.15	POL-331.20 \$46.50	Bullet	Medium (Black)	1" x 1/4"
POL-330.30	\$6.15	POL-331.30 \$46.50	Bullet	Fine (Lt. Blue)	1" x 1/4"
POL-330.40	\$6.45	POL-331.40 \$49.90	Bullet	Extra-Fine (Pink)	1" x 1/4"
F. POL-325.10	\$13.75	POL-326.10 \$97.70	Large Cylinder	Coarse (White)	3/4" x 15/32"
POL-325.30	\$13.75	POL-326.30 \$97.70	Large Cylinder	Fine (Lt. Blue)	3/4" x 15/32"

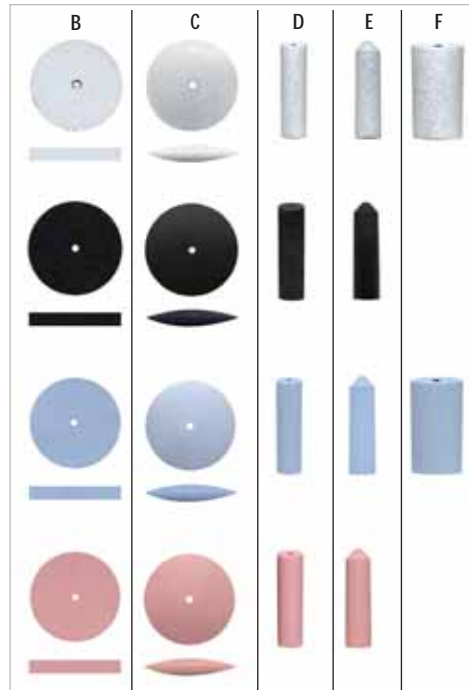

White (Coarse) Polishers can be used for ceramics, acrylics and pre-polishing of precious metals.

Black (Medium) Polishers are used for polishing of precious metals.

Blue (Fine) Polishers give a high shine.

Pink (Extra-Fine) Polishers give a super high shine to precious metals.

GOLD POLISHERS

These high quality green polishers are long lasting and highly flexible for use on gold and other precious metals. German-made and available unmounted in medium grit. Operating speed 5,000 - 10,000 RPM. Sold in dozens or bulk packs.

	12/pk	100/pk	Style	Size
G. POL-410.20	\$6.35	POL-411.20 \$45.85	Knife-Edge, 7/8"	22 x 3.5mm
H. POL-410.21	\$6.35	POL-411.21 \$45.85	Wheel, 7/8"	22 x 3mm
I. POL-410.22	\$6.35	POL-411.22 \$45.85	Cylinder	7 x 20mm
J. POL-410.23	\$6.35	POL-411.23 \$45.85	Bullet	6 x 24mm

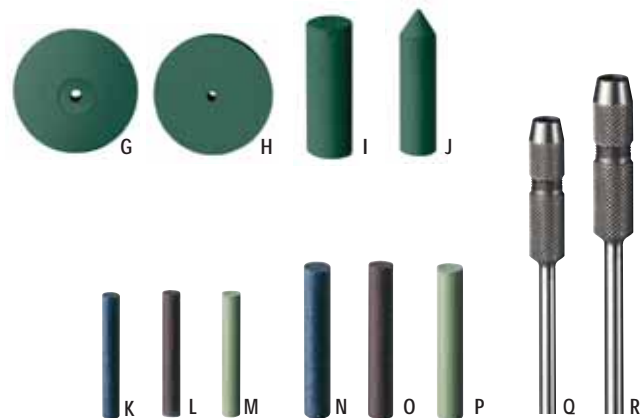

SILICONE POLISHING PINS

Very slender and strong pins for polishing areas which are difficult to access. Available in three grits and two sizes. Sold per package of 12. High quality 3/32" shank pin holders available for each size polishing pins. Made in USA.

Stock #	Description	Size	Qty.	
K. POL-420.60	Medium Grit (Gray)	2 x 20mm	12/pk	\$6.15
L. POL-420.70	Fine Grit (Brown)	2 x 20mm	12/pk	\$6.15
M. POL-420.80	Extra-Fine Grit (Green)	2 x 20mm	12/pk	\$6.15
N. POL-430.60	Medium Grit (Gray)	3 x 23mm	12/pk	\$6.55
O. POL-430.70	Fine Grit (Brown)	3 x 23mm	12/pk	\$6.55
P. POL-430.80	Extra-Fine Grit (Green)	3 x 23mm	12/pk	\$6.55
Q. MAN-420.00	Pin Holder for 2mm Polishing Pins			\$6.25
R. MAN-430.00	Pin Holder for 3mm Polishing Pins			\$6.25

LARGE SILICONE POLISHING WHEELS

High quality silicon rubber with impregnated silicone carbide to use with your buffing machines. Use with a 1/2" straight arbor only. Maximum 3,600 RPM.

Stock #	Description	Size	Center Hole	
S. POL-490.50	Coarse	4" x 9/16"	1/2"	\$28.50
T. POL-490.60	Medium	4" x 9/16"	1/2"	\$28.50
U. POL-490.70	Fine	4" x 9/16"	1/2"	\$28.50
V. POL-490.80	Extra-Fine	4" x 9/16"	1/2"	\$29.00

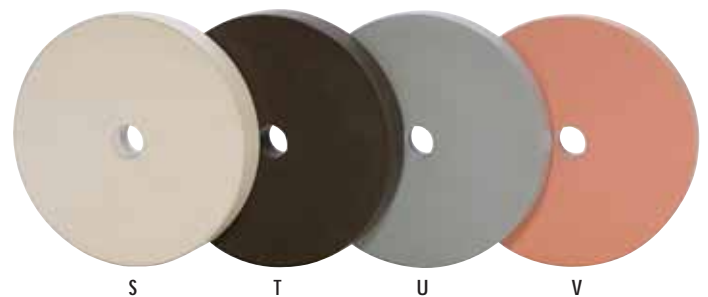

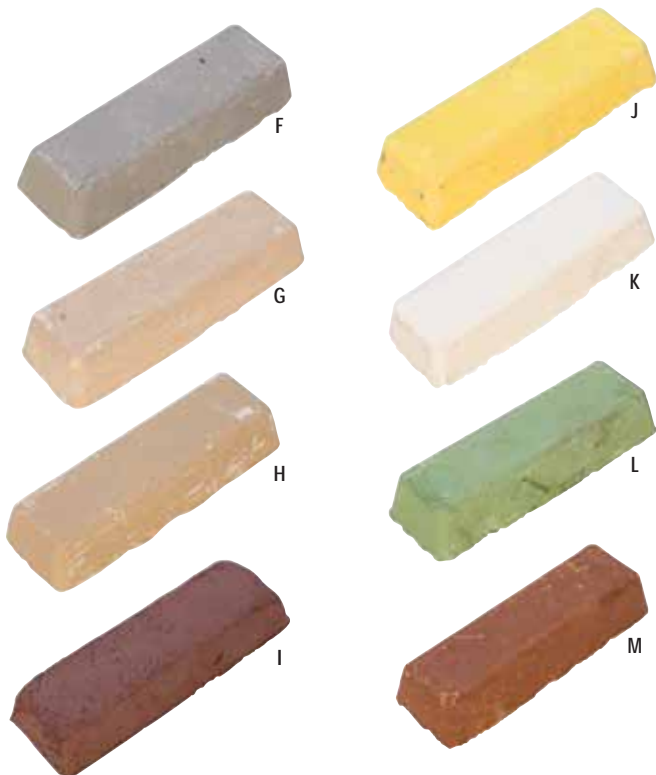

BLUE MAGIC PLATINUM POLISH

EURO TOOL now offers a premium German-made compound engineered especially for platinum. Tests by professional jewelers indicates that Blue Magic leaves the best shine that they have ever seen. Excellent for gold and other metals too.

Stock #	Weight	
A. POL-605.00	1/4 lb. Bar	\$8.95

ZIP BUFFING COMPOUND

Zip buffing compound is the perfect compound for silver. Zip will not scratch soft stones so they don't have to be removed before buffing, saving the user time. Excellent also as a final finish for gold. It leaves a high luster and has no residue.

Stock #	Weight	
B. POL-612.25	1 lb. Tube	\$5.75

EUROLUSTRE

Exceptional, special formula will remove light scratches and produce a mirror finish with no discoloration. For use on all types of precious metals plus brass and pewter. Consistency of EuroLustre is greaseless for easy clean-up with little or no residue.

Stock #	Weight	
C. POL-610.25	1 lb. Tube	\$5.35

PLATINUM TRIPOLI

Our specially formulated platinum tripoli is step one in removing light scratches before preparing platinum for final polish with our Brite White. Leaves a non-reflective finish that polishes to a high luster quickly. Also excellent for other hard metals including stainless steel.

Stock #	Weight	
D. POL-600.00	1/4 lb. Bar - Brown	\$4.10

PLATINUM BRITE WHITE POLISHING COMPOUND

A breakthrough for platinum by EURO TOOL! A white compound which makes polishing platinum effortless compared to existing compounds - plus it gives a much brighter shine. Brite White makes clean-up easy because it is relatively dry, leaves little residue and washes out better than conventional rouge. Thoroughly tested by manufacturing jewelers - we guarantee your satisfaction!

Stock #	Weight	
E. POL-601.00	1/4 lb. Bar	\$6.35

CUTTING and POLISHING COMPOUNDS

Using cutting and polishing compounds is the last step in producing fine jewelry pieces, so great care must be taken to use the best quality available. Our selected compounds offer the user the finest quality and variety needed. Sold in bars of 1 lb. (approximate weight).

Stock #	Description	
F. POL-625.05	Gray Star - 1 lb. Bar Smooth rough edges; remove scratches; superior cutting action	\$5.85
G. POL-625.10	XXX White Diamond - 1 lb. Bar Finer abrasive for extra fast cutting of silver and other soft metals	\$2.65
H. POL-625.15	Bobbing Compound - 1 lb. Bar Fast cutting for use in wheel, brush and lap work.	\$2.95
I. POL-625.20	Red - 1 lb. Bar For final color, high lustre finish, and smooth polish on gold, silver, sterling and other soft metals.	\$5.95
J. POL-625.25	Yellow - 1 lb. Bar Good all-around, low residue compound for use on gold, chrome platinum, stainless steel and other hard metals.	\$4.05
K. POL-625.30	White - 1 lb. Bar Polishing rouge with exceptional cutting action on all hard metals such as platinum, chrome, nickel and stainless steel.	\$4.30
L. POL-625.35	Green - 1 lb. Bar For high luster on hard and soft metals. Delivers higher luster than yellow or white rouge.	\$9.75
M. POL-625.40	Brown Tripoli - 1 lb. Bar Fast cutting, standard compound for any metal; used prior to final polish with rouge.	\$2.75

POLISHER/DUST COLLECTOR

Our polisher and dust collector quietly and efficiently collects metal particles, dust and lint from your work. Designed for professional jewelers and craftsmen, it offers matchless durability, outstanding value and exceptional performance. Constructed from heavy gauge steel frames for long life and dependable service. White industrial polyurethane paint resists surface abrasions and wipes clean easily. Built-in lighting increases visibility making work more productive and comfortable. Filter replacement and metal reclamation are simple with the removable hood. Accepts buffs 6" diameter and smaller. This model is portable, quiet, clean and efficient. Complete with 3,500 RPM, 1/3 hp 115 volt open frame motor and 1/2" tapered spindles. Measures 16 1/2" D x 24" W x 12" H. Shipping weight 55 lbs. Limited one year warranty.

Stock #	Description	
A. POL-288.00	Polisher/Dust Collector	\$499.00
POL-288.10	Replacement Filter, 12" x 24" x 1"	\$10.95
POL-288.50	Motor Only	\$169.95



ADAPTER CHUCK

Chuck with 3 collets will take bits from 0 to 2.5mm, drill sizes 80-40. Because the mandrel shank is 3/32", this chuck is excellent to use with flex shaft machines. Made in Europe of hardened tool steel.

Stock #	Description	
B. BRS-280.00	Chuck with 3 Collets	\$13.10



ADAPTER MANDRELS

This adapter mandrel, which fits on a tapered spindle can be used with any 1/8" hole miniature brush. This enables the user to run brushes such as our metal-hub brushes with a large motor.

Stock #	Description	
C. BRS-270.00	White, Right Hand Mandrel	\$7.95
D. BRS-271.00	Black, Left Hand Mandrel	\$7.95

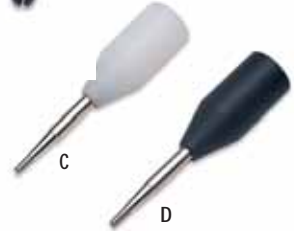

TAPERED SPINDLES

Steel spindles mount on 1/2" straight-shaft motors with 2 set screws. The deep-cut threads hold buffs securely. Length 3 3/4".

Stock #	Description	
E. BUF-903.10	1/2" Right	\$5.00
F. BUF-903.20	1/2" Left	\$5.00



WOOD POLISHING MANDREL

Designed specifically to hold rings while polishing. 9" long and made of straight-grained tapered hardwood; you can be assured of holding rings without damaging them in any way.

Stock #		
G. HOL-116.00		\$4.50



POLISHING GIZMO

This addition to our line gives the user the benefit of a device to hold bracelets and rings for polishing. Made of select hardwood, the Polishing Gizmo is an indispensable tool for any bench. It is varnished so that the surface will repel rouge.

Stock #		
H. HOL-116.50		\$10.95



Safely polish bracelets, rings, chains and more with the Polishing Gizmo.

HANDLE w/ CHUCK for POLISHING MOTORS

This handy adapter makes it easy to use 1/8" shank brushes, buffs and other small rotary tools in conjunction with your polisher/dust collector. It fits right onto the tapered spindle.

Stock #		
I. HAN-732.00		\$9.05



Finger Pro – the ultimate protection from cuts, burns and abrasions. See page 36 for more details.

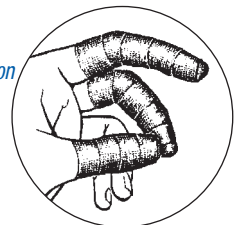



A

New!



B



New!



C

D

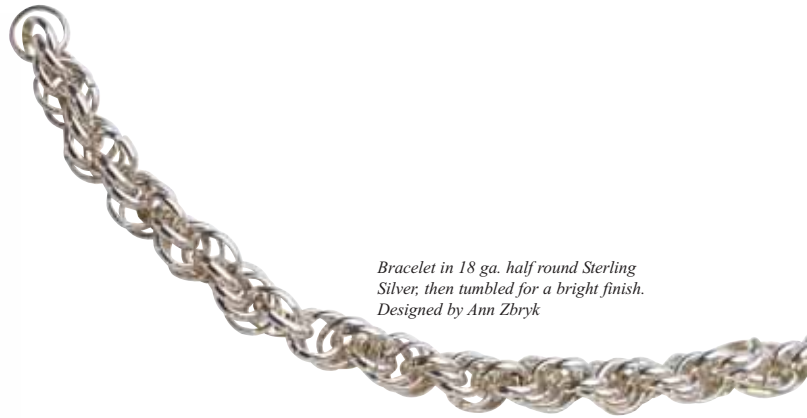

Bracelet in 18 ga. half round Sterling Silver, then tumbled for a bright finish. Designed by Ann Zbryk

LORTONE 3A SINGLE BARREL TUMBLER

Model 3A tumbler with a simple 3 lb. capacity barrel offers the user economy and performance. Designed for years of trouble free service, the 3A is a real work-horse. The barrel is hard rubber to minimize noise and the durable motor will last for years. Simple to operate and UL approved. Weight: 5 lbs. One year warranty.

Stock #	Description	
A. TUM-110.00	Single Barrel Tumbler	\$82.95
TUM-110.05	Replacement Barrel	\$25.95

LORTONE 33B DOUBLE BARREL TUMBLER

This small double barrel tumbler has two 3 lb. barrels each with a quick-seal closure. Tumble twice as much at one time. Or run two operations at once such as polishing and grinding. Weight 7 lbs. Simple to operate and UL approved. One year warranty.

Stock #	Description	
B. TUM-112.00	Double Barrel Tumbler	\$112.95
TUM-110.05	Replacement Barrel	\$25.95

SHINEBRITE™ BURNISHING COMPOUND

Our specially formulated liquid burnishing compound possess unique detergent, burnishing and descaling properties required for essential jewelry finishing. Shinebrite is an odorless, biodegradable concentrate designed for use with steel media. Leaves your work pieces bright and clean. Mix 2 oz to make 1 gallon of solution.

Stock #	Description	
C. TUM-510.10	Shinebrite Burnishing Compound, Quart (makes 16 gallons)	\$12.95
D. TUM-510.01	Shinebrite Burnishing Compound, 8 oz (makes 4 gallons)	\$4.95



STAINLESS STEEL SHOT

Highly polished stainless steel shot mixture known as the "Jewelers' Mix" is a combination of three shapes: diagonal, round and pin. Each does a different job in burnishing metals to a mirror bright finish in the minimum amount of time. For almost all applications, it is the only shot combination you'll ever need. Stainless steel requires only occasional cleaning and gives great uniformity. Because it is stainless steel, it is rust and corrosion resistant and able to stand up to strong compounds.

Stock #	Description	
TUM-125.02	2 lbs.	\$39.95
TUM-125.50	50 lbs.	\$769.00

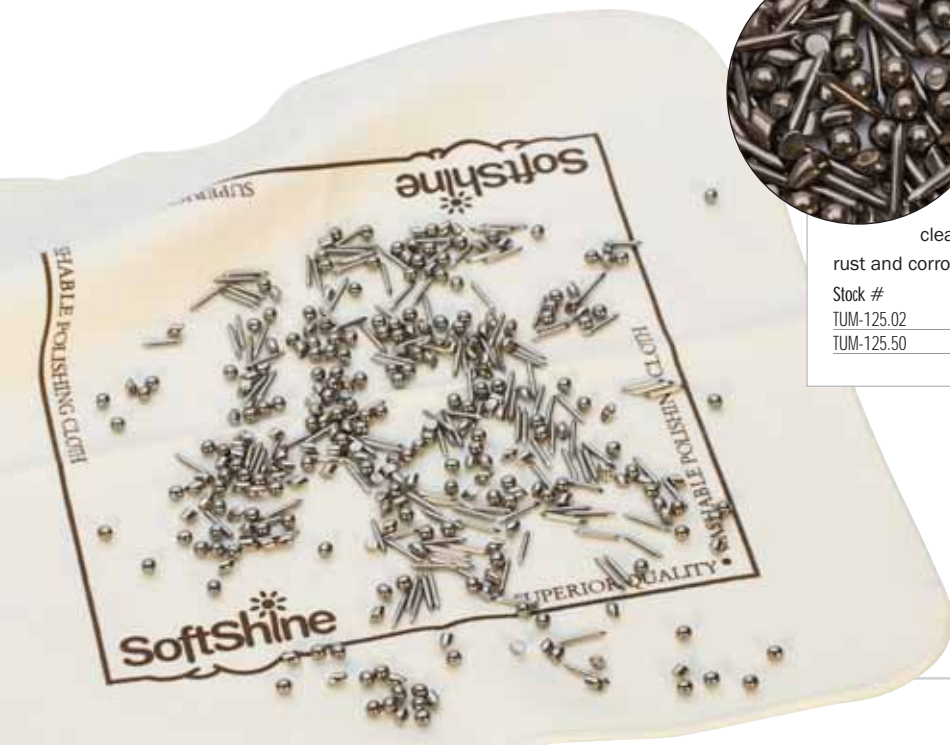

LINTLESS DIAMOND CLOTH

Our 10" x 10" lintless cloth is perfect for removing oils and other contaminants from diamonds and precious stones. In bright gold, this synthetic cloth works great and looks lovely on the retail counter.

Stock #	Size	
A. POL-804.00	10" x 10"	\$3.75



A

SOFTSHINE™ POLISHING CLOTH

SoftShine™ Cloth is perfect for applications where a non-treated cloth is needed. Each cloth is individually packaged for counter display and has the perfect feel. Smaller cloth ideal for a giveaway. Lintless, with a high degree of absorbency, SoftShine™ is perfect for removing fingerprints from gold, silver, crystal or any other polished surface.

Stock #	Size	
B. POL-807.00	10" x 10"	\$5.95
POL-807.04	5" x 5"	\$1.45



B

Softshine available in 5" x 5" or 10" x 10".

SELVYT POLISHING CLOTHS

Selvyt cloths have a soft, no-lint surface that cleans precious metals, crystal and silverware without scratching. It does not leave deposits after cleaning and can be washed many times. Perfect for retail counters.

Stock #	Style	Size	
C. POL-908.01S	A	10" x 10"	\$6.25
POL-908.02S	B	14" x 14"	\$9.30
POL-908.04	00	5" x 5"	\$1.59



C



D

CHAMOIS POLISHING CLOTH

The perfect material for polishing all types of metals, the chamois cloth has been recognized for years as the ultimate. Try this genuine white 10" x 10" chamois for final polishing.

Stock #	Size	
D. POL-175.00	10" x 10"	\$5.90

EURO SHINE COUNTER CLOTH

The Euro Shine cloth is made of synthetic microfibers. This blue cloth is washable and reusable. It will take off dirt, grease and debris, including lipstick from mirrors or glass surfaces. The Euro Shine cloth is excellent for retail stores to keep counters and mirrors spotless without having to use harmful chemicals. Spray the surface with a small amount of plain water and wipe. It is hard to believe, but surfaces come clean instantly.

Stock #	Size	
E. POL-690.00	11 1/2" x 15 1/2"	\$10.95



E

F. ANTI-STATIC PANTHER CLOTH

Anti-static microfiber cleaning cloth has strips of conductive fibers that effectively dissipate and drain off static charges. Thousands of small pockets in the microfiber capture dust, lint and other debris from any surface making it ideal to use on glass, diamonds and crystals. May be used with cleaning solutions. Made from 100% polyester fiber.

Stock #	Size	
POL-813.01	5 1/4" x 5 3/4"	\$4.95
POL-813.02	8" x 8"	\$6.95
POL-813.03	10" x 18"	\$7.95



F

G. DIAMOND CLEANING CLOTH

Black, anti-static diamond cleaning cloth makes diamonds, gems and crystals sparkle. Captures minute dust and dirt particles as well as dissipates static. Made of 100% polyester fiber.

Stock #	Size	
POL-812.02	8" x 8"	\$5.95
POL-812.03	10" x 18"	\$7.95



G



A

Ultra-Polish Pads are great for high-lighting when using Liver of Sulfur. See page 205.

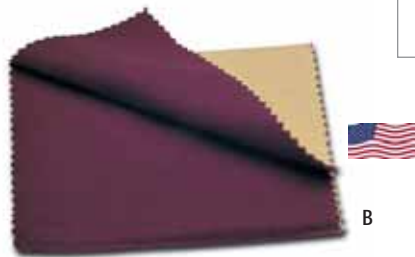

B

EXCLUSIVE



C



D



E



F



G

ULTRA-POLISH PADS

Fast and easy, these convenient sized Ultra-Polish Pads are great for removing tarnish, highlighting when using liver of sulfur or silver black, or polishing to a high luster. Leaves no residue. They are made of thin, tight-bond foam with permanently bonded micro-abrasives. A handy economical polisher that is truly amazing. Sold in packs of 20.

Stock #	Description	Size	Qty.	
A. POL-695.00	Ultra-Polish Pads, pk/20	2" x 2"	pk/20	\$6.50

B. ROUGE CLOTHS

Available in two sizes, our deluxe cotton rouge cloth offers great value. It is impregnated with the finest quality red rouge on one side while the other side is left plain soft flannel for the final polish. Quality made in the USA. Smaller size available private labeled with a minimum order of 500.

Stock #	Size	
POL-168.00	6" x 8"	\$3.65
POL-169.00	9" x 11"	\$5.20

C. "BRILLIANT" POLISHING CLOTHS

"Brilliant" products are treated with a newly developed chemical agent which cuts through tarnish better than other cloths and inhibits tarnish from reappearing. You can polish brass, chrome, copper, silver and gold brilliantly without getting rouge on your hands.

Stock #	Description	Size	
POL-700.00	Blue	4" x 6"	\$1.95
POL-705.00	Blue	12" x 7 1/2"	\$2.99
POL-710.00	Blue	12" x 15"	\$5.04
POL-715.00	Yellow	12" x 7 1/2"	\$3.65

D. DOUBLE "BRILLIANT" POLISHING CLOTHS

This double cloth features one side impregnated with a harmless chemical that removes tarnish while leaving a slight residue that inhibits further tarnish. The other side is not impregnated, so the user can clean the excess chemical from the piece if desired. This cloth accomplishes the same objective as combination cloth with rouge, but without leaving the mess on the user's hands that rouge does. Handy and durable, the Double Brilliant Cloth makes polishing and clean up easy.

Stock #	Description	Size	
POL-170.00	Blue / Yellow Double Cloth	7 1/2" x 12"	\$5.09
POL-171.00	Blue / Yellow Double Cloth	6" x 7"	\$2.35

SELYT SILVER CLOTH

Impregnated silver cleaning cloth, ideal for use both in the workplace and in the home. Manufactured in a chemically impregnated cotton fabric which also has an anti-tarnish agent, these cloths are ideal to clean dirty and tarnished silverware.

Stock #	Size	
E. POL-167.00	10" x 10"	\$6.95

GEMBRIGHT LINTLESS CLOTH

Our 9" x 10" GemBright Lintless Cloth is truly that. With a revolutionary micro fiber that will not snag or shed, it is the optimal texture and softness for cleaning film from precious stones, especially diamonds. Untreated, a lovely powder blue color, packaged one to a hang-up bag for excellent counter display. Fast becoming the standard of the industry.

Stock #	Size	
F. POL-805.00	9" x 10"	\$4.95

VELVET WAND

The Velvet Wand is the way to keep your displays and boxes looking clean and new. With its rounded corners and flexible shape, it can easily clean any surface shape and reach the corners of display cases, jewelry boxes, etc. One side for removing lint or dust, the other for de-pilling, and lifting the nap on crushed or matted fabrics. Reusable – simply pull fuzz off to clean or can be washed in cold water.

Stock #	Size	Qty.	
G. POL-745.00	7" x 1"	pk/3	\$9.00

New! All new metal clay tools...

METAL CLAY PRO-DESIGN SHAPERS - ST/9

Highest quality material is used to create this set of nine 6½" double-ended shapers. Made of molded plastic, each shaper is easy to hold when making a variety of shapes and patterns. Use your imagination to fashion single or unique repeated patterns on clay. Clean up is easy with the non-stick surface.

Stock #	Size	
A. CVR-250.00	Set of 9, Double Ended	\$26.95

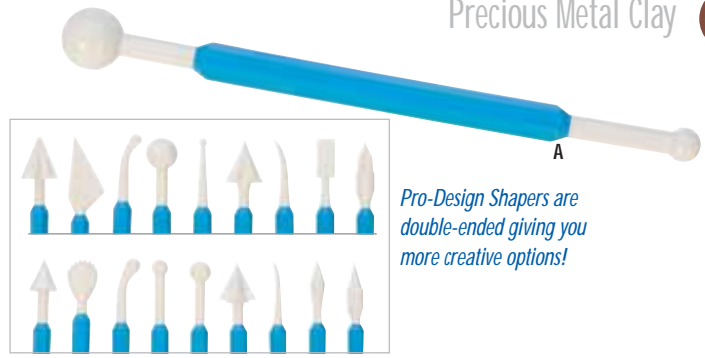

Pro-Design Shapers are double-ended giving you more creative options!

PATTERN/TEXTURE TOOL with THREE WHEELS

Use this unique tool to make small repeated designs on clay. Made of a hardened plastic, non-stick material that is easy to clean and will not wear out. The wheels are interchangeable on the easy to hold 4½" handle. Great for straight or free hand curved designs.



Stock #	
B. CVR-255.03	\$12.95

Each Pattern/Texture Tool includes handle and three design wheels.



PMC PATTERN ROLLERS

Making specific patterns on clay has never been easier. Sold individually, the Pattern Rollers are made of a lightweight plastic and non-stick material, they feature 6 patterns; wood grain, mosaic, brick, pinstripe, smooth and basket weave. The pattern is easily transferred evenly onto the clay with minimal effort.

Stock #	Description	Length	Roller Length	
C. ROL-800.07	Mosaic	3¾"	1¾"	\$11.95
D. ROL-800.09	Wood Grain	3¾"	1¾"	\$11.95
E. ROL-800.10	Smooth	3¾"	1¾"	\$11.95
F. ROL-800.12	Basket Weave	3¾"	1¾"	\$11.95
G. ROL-800.20	Pin Stripe	3¾"	1¾"	\$11.95
H. ROL-800.22	Brick	3¾"	1¾"	\$11.95

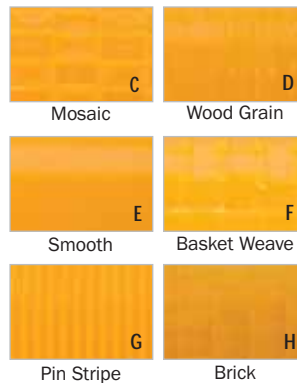

MINI METAL CLAY PRO-DESIGN SHAPERS – ST/14

Create unique patterns with this set of 14 double-ended shapers for a total of 28 shapes. With very fine tips, the possibilities are nearly endless. Simple to use and made of a non-stick hard plastic material for easy clean up.

Stock #	Description	Length	
I. CVR-254.00	Set of 14, Double-Ended	4½"	\$17.95



THREE SIDED TEXTURING TOOL

If you are looking for a sturdy, economical texturing tool; this is the one. Made of light-weight aluminum this triangular shaped tool has 3 different sized 'teeth' on each 4" side. Great for making simple grooved impressions or use it multi directional for a geometric pattern.

Stock #	Size	
J. CVR-243.00	4"	\$1.95

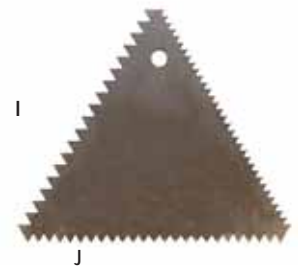

DOUBLE-ENDED SHAPER/CARVER

Double-ended Colour Shapers offer a fine flexible silicon tip on one end and a loop carver on the other. Use to carve, smooth, and sculpt with exact and precise control. The silicon tip is strong and durable, and after use it easily washes clean.

Stock #	Description	
K. BRS-897.21	Flat/Chisel, #2	\$10.95
L. BRS-897.22	Taper/Point, #2	\$10.95



COLOUR SHAPERS

Our new Colour Shapers are excellent to sculpt and add incredible effects to Metal Clay work. Somewhere between a brush, a palette knife, a modeling tool and your fingers, the #6 Shapers are made with a soft, flexible silicon tips for subtle detailing or broad strokes. Easy-to-clean and long lasting. Offered in 5 shapes with color coded hardwood handles or as a set of five.

Stock #	Size	Color	
M. BRS-896.01	Tapered Chisel	Red	\$8.95
N. BRS-896.02	Rounded Cup Chisel	Green	\$8.95
O. BRS-896.03	Cup Chisel	Yellow	\$8.95
P. BRS-896.04	Flat Chisel	Orange	\$8.95
Q. BRS-896.05	Angled Chisel	Blue	\$8.95
BRS-896.09	Set of Five Colour Shapers		\$28.50



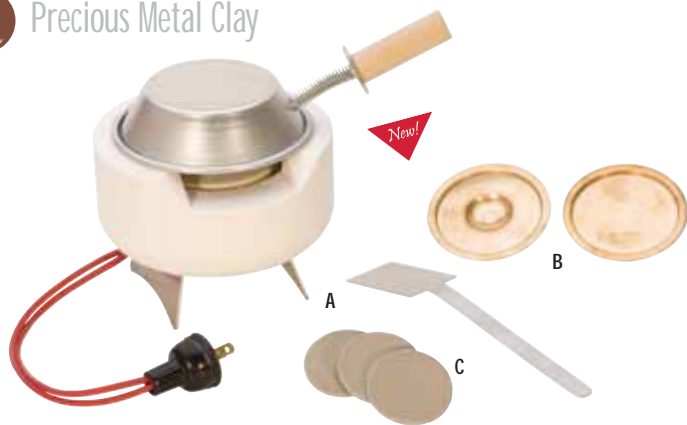

Keishi pearls strung with PMC freeform shapes embellished with Keum-boo process, 24k yellow gold foil. The PMC pieces have had a patina applied by using liver of sulphur.



PMC with Keum-boo and Keishi Pearl Necklace
Designed by Dana Dollins



Don't forget the .999 stamp to complete your silver metal clay work – see page 107



ULTRALITE KILN

The UltraLite Beehive Jewelry Kiln was originally developed for fine metals granulation and enameling, but is the perfect choice for firing metal clay products or Keum-boo. The kiln heats quickly and thoroughly. The firing surface is 3" in diameter by 1½" high and the element produces a working temperature of 1550°F. Kiln body consists of high insulating ceramic fiber. Comes with standard 15" Cord and stainless steel working spatula. Complete instructions included. Optional red brass covers specially designed for Keum-boo can be inserted above the element of the UltraLite kiln to moderate heat inside the kiln. One plate for flat pieces, the other with a depression allows for non-flat pieces. Optional three piece textured Ceramic Disc Set is specially designed to be inserted in the UltraLite kiln for firing metal clay. With the ceramic insert, the kiln heats quickly and evenly. Made in the USA. Recommended for professional adult use only.

Stock #	Description	Size	
A. KLN-100.00	UltraLite Kiln	5½" x 5½" x 6½"	\$169.00
B. KLN-100.10	Keum-Boo Plates, st/2		\$29.95
C. KLN-100.05	Ceramic Inserts, st/3		\$23.50

MULTIMANDEL™ RING MANDREL SET

This six piece ring mandrel set is ideal for making PMC rings as well as for the traditional wax worker. The steel mandrel stand can be inverted so that you can work on rings from two directions. The mandrel can be easily removed from the holder for the handheld detail work. The mandrel set consists of six aluminum mandrels covering sizes 4 to 15, allowing you to make PMC rings in sizes 2 to 13 with shrinkage. Additional six piece mandrel set of half sizes 4.5 to 15.5 is also available. Optional wood stand keeps your mandrels visible and handy.

Stock #	Description	
D. MAN-140.10	MultiMandrel™ Set with Six Mandrels (whole sizes 4 to 15)	\$44.95
MAN-140.25	Set of Six Mandrels (half sizes 4.5 to 15.5)	\$35.80
MAN-140.02	Wood Stand	\$8.95

DOUBLE-SIDED STEPPED MANDREL

Revolving stepped aluminum mandrel on nickel-plated center base. Allows for a full 360° horizontal or vertical rotation. Ideal for wax model building or metal clay work. Smoothly and easily turn your piece as you work. Sizes 4-14 clearly marked on the stepped mandrel. Mandrel can easily be removed from stand for doing handheld detailed work. 6" x 4" base with a 12" mandrel.

Stock #	
E. MAN-138.00	\$29.95

STEPPED RING MANDREL ON BASE

Stepped aluminum mandrel securely mounts on a steel base and easily rotates 360°. The smooth round steps allow you to precisely size rings when wax working or using metal clay. Mandrel is clearly marked with sizes 4-13 and can be removed from the stand for handheld use. 13" total length.

Stock #	
F. MAN-139.00	\$21.95

TRIPOD with MESH SCREEN

Tripod with mesh screen used to stand over an alcohol lamp or Bunsen burner for soldering.

Stock #	Size	
G. SOL-730.00	9" Tripod with Mesh Screen	\$9.65
H. SOL-735.00	6" Tripod with Mesh Screen	\$8.95
SOL-730.10	Replacement 6" x 6" Mesh Screen	\$2.85

I. NON-STICK MAGIC MAT

This special non-stick hard plastic mat is ideal for precious metal clay work. Available in 12" x 12" or 6" x 6", for smaller projects, classroom work or to keep in your tool kit.

Stock #	Size	
MAT-612.00	12" x 12"	\$14.95
MAT-612.04	6" x 6", pk/4	\$15.95

REHYDRATION SPRAY BOTTLE

Four ounce spray bottles sold in a packs of three. Use to place just enough water to re-moisturize your metal clay.

Stock #	Size	
A. PKG-252.04	4 oz., pk/3	\$3.95

METAL CLAY BLADE

Make clean and precise cuts in precious metal clay with this tissue blade. Made of stainless steel sold in packs of two. This is a precision cutting and slicing instrument and should be handled with care. CAUTION: BLADE IS EXTREMELY SHARP.

Stock #	Description	Size	
B. KNF-282.50	Metal Clay Blade - pk/2	6"	\$4.99

NON-STICK METAL CLAY ROLLER

White non-stick roller for metal clay. Comes complete with three sizes of rubber spacers - 1/16", 3/32" and 1/8".

Stock #	Description	Size	
C. ROL-108.00	Roller with Spacers	8"	\$14.95
ROL-108.01	Spacers - Set of Three	1/16", 3/32" and 1/8"	\$5.95

PALETTE KNIFE

Flexible blade palette knife for mixing and projects where a small "spatula" is useful.

Stock #	Size	
D. KNF-718.00	6"	\$2.35

SLIP BRUSH

Quality import artist brush #1 is great for adding patinas or applying slip to join elements, make repairs or reinforcing areas. Total length 8 1/4", bristle length 1/2".

Stock #		
E. BRS-495.00		\$1.95

AGATE BURNISHERS

Natural agate stone burnishers are the perfect tool for metal clay work, applying gold and silver foil or Keum-boo applications. Also works to burnish unfired metal clay. Can be used like a steel burnisher for smoothing metals and closing bezels, but unlike steel burnishers, they will not damage stones.

Stock #	Description	Length	
F. BRN-620.05	Agate Burnisher - Straight	8 1/2"	\$13.35
G. BRN-620.06	Agate Burnisher - Knife	8 1/2"	\$13.35



A



PMC Necklace designed by Dana Dollins

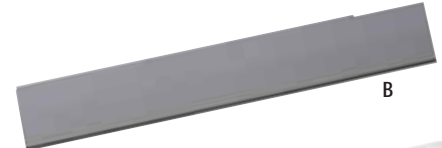

B



C



D

New!



E



F



G

New!

Metal Clay Kits

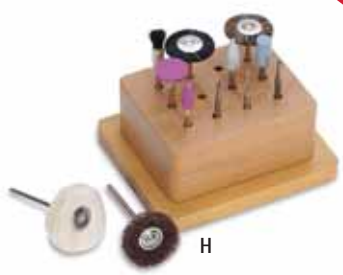

H

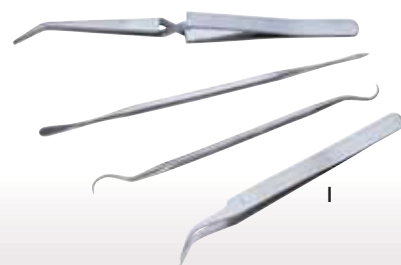

I



J

PMC ACCESSORY KIT

This accessory kit features an attractive wood base and twelve of the handiest tools for working PMC. All tools have 3/32" (2.35mm) shanks and can be used with our hand motor HDP-375.00, Dremel tools or a #30 style hand piece. Set includes: 3 brushes, 1 buff, 2 burs, 1 drill, 1 texturing wheel, 2 grinding points and 2 silicone polishing points. These are the same tools used by manufacturing professionals for cleaning, texturizing, polishing and shaping - assembled just for you!

Stock #	Description	
H. HDP-350.12	12pc Accessory Kit	\$24.95

FOUR PIECE PMC KIT

Our tweezer/pick set is perfect for PMC and a variety of other applications. With a double-ended pick for cleaning, a double-ended carver for shaping and smoothing, a #7 tweezer for positioning and handling and a negative locking tweezer for holding or clamping one can do many jobs quickly and efficiently. All tools are stainless steel for years of service.

Stock #		
I. TWZ-700.40		\$9.95

DELUXE TOOL KIT FOR METAL CLAY

A great tool kit for precious metal clay work. Includes precision tools needed for designing and creating all neatly stored in a rugged tool case. Case allows enough room to store your clay as well as other metal clay supplies. This kit includes:

- Curved Burnisher
- Double-ended Carver
- Square Carver/Shaper
- Double-ended Carver
- Palette Knife
- Rehydration Bottle
- Awl
- Flexible Blade
- Brass Brush
- Paint/Slip Brush
- Soft Grip Knife
- Tool Box

Stock #	Description	
J. KIT-430.08	12pc Deluxe Tool Kit for Metal Clay	\$34.95

New!

METAL CLAY DESIGN BLOCKS

Innovation meets high quality in our new line of metal clay design blocks. The creative outlets for your talents become endless possibilities. Our exclusive metal clay design stamps are precision machine cut from high-quality beechwood. These copyrighted designs are offered in a wide variety of styles including basic geometric patterns, Celtic knot designs, southwest inspired characters, traditional designs, Chinese symbols, animal figures, and more. The blocks are proportionately sized which allows them to be used in conjunction with each other to expand the pattern and design options. Made of a fine-grained hardwood and treated with oil for durability, each stamp offers two different designs, one at each end. All blocks are beveled at each end and are 7.0cm long. Stock numbers are noted below each block.

EXCLUSIVE



Jewelry Designed by Dana Dollins

Square Blocks
1.5cm x 1.5cm



STM-110.01 \$5.50



STM-110.02 \$5.50



STM-110.03 \$5.50



STM-110.04 \$5.50



STM-110.05 \$5.50



STM-110.06 \$5.50



STM-110.07 \$5.50



STM-110.08 \$5.50



STM-110.09 \$5.50



STM-110.10 \$5.50



STM-110.11 \$5.50



STM-110.12 \$5.50



STM-110.13 \$5.50

Rectangular Blocks
1.5cm x 3.0cm



STM-130.01 \$7.95



STM-130.02 \$7.95



STM-130.03 \$7.95



STM-130.04 \$7.95



STM-130.05 \$7.95



STM-130.06 \$7.95



STM-130.07 \$7.95



STM-130.08 \$7.95



STM-130.09 \$7.95



STM-130.10 \$7.95

Square Blocks
3.0cm x 3.0cm



STM-311.23 \$8.95



STM-311.28 \$8.95



STM-314.73 \$8.95



STM-314.74 \$8.95



STM-311.28 \$8.95



STM-311.30 \$8.95



STM-314.74 \$8.95



STM-314.75 \$8.95



STM-311.30 \$8.95



STM-314.70 \$8.95



STM-314.75 \$8.95



STM-314.76 \$8.95



STM-314.70 \$8.95



STM-314.71 \$8.95



STM-314.76 \$8.95



STM-314.77 \$8.95



STM-314.71 \$8.95



STM-314.72 \$8.95



STM-314.77 \$8.95



STM-314.78 \$8.95



STM-314.72 \$8.95



STM-314.78 \$8.95



STM-314.78 \$8.95



STM-314.78 \$8.95

* Please note block images are not to scale.

Equilateral Triangle Blocks
1.5cm



STM-120.01 \$5.50



STM-120.02 \$5.50



STM-120.03 \$5.50



STM-120.04 \$5.50



STM-120.05 \$5.50



STM-120.06 \$5.50



STM-120.07 \$5.50



STM-120.08 \$5.50



STM-120.09 \$5.50



STM-120.10 \$5.50

Equilateral Triangle Blocks
3.0cm



STM-322.40 \$8.50



STM-322.41 \$8.50

Square Blocks
3.0cm x 3.0cm



STM-315.81 \$8.95



STM-315.83 \$8.95



STM-110.200 Small (1.5 x 1.5cm) \$5.50
STM-310.200 Medium (3.0 x 3.0cm) \$8.95



STM-315.86 \$8.95



Keep blocks well-oiled for prolonged life.

Square Blocks – 3.0cm x 3.0cm



STM-312.40 \$8.95



STM-312.42 \$8.95



STM-312.41 \$8.95



STM-312.43 \$8.95



Rectangular Block – 3.0cm x 6.0cm



STM-632.42 \$9.95



Rectangular Blocks – 1.5cm x 6.0cm



STM-671.02 \$9.95



STM-671.01 \$9.95

Hex Block Set of 3
1.5cm

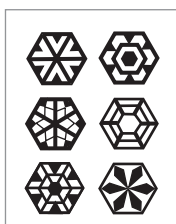

STM-140.90 \$23.85

Hex Block Set of 3
3.0cm

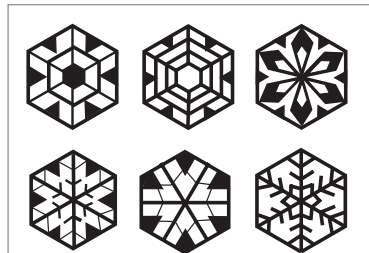

STM-340.90 \$26.85

Triangular Block Set of 3
1.5cm x 3.0cm

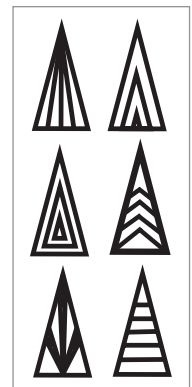

STM-150.90 \$23.85



Use combinations to create endless patterns!

Square Blocks
1.5cm x 1.5cm (Small); 3.0cm x 3.0cm (Medium)



STM-113.60 Small \$5.50
STM-313.60 Medium \$8.95



STM-113.62 Small \$5.50
STM-313.62 Medium \$8.95



STM-113.63 Small \$5.50
STM-313.63 Medium \$8.95



STM-113.65 Small \$5.50
STM-313.65 Medium \$8.95



STM-113.68 Small \$5.50
STM-313.68 Medium \$8.95



STM-113.69 Small \$5.50
STM-313.69 Medium \$8.95



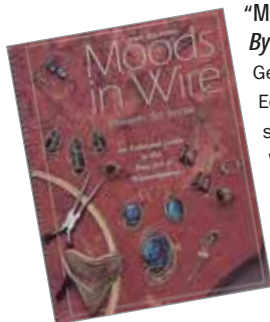

“MOODS IN WIRE” – 2ND EDITION

By Ed Sinclair

Get the best of both worlds in Ed Sinclair's 2nd Edition of "Moods in Wire". Offering a comprehensive combination of his first two books "Moods In Wire" is the standard for wire wrapping. A valuable guide to anyone interested in the art of wire wrapping. The book is spiral bound so it will lay flat if being used as an instruction manual.

Stock #
PUB-115.50 192 Pages \$29.95

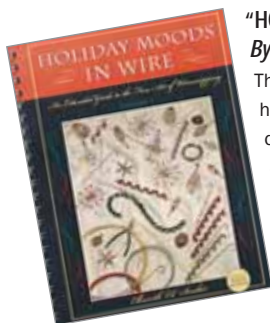

“HOLIDAY MOODS IN WIRE”

By Ed Sinclair

This how-to book shows variations of many different holiday projects each diagrammed and described in detail. Includes demonstrations on how to do three dimensional angels, candy canes, miniature trees, religious symbols, pendants and wreaths – enough to stir the imagination of anyone who loves wire wrapping.

Stock #
PUB-117.00 156 Pages \$29.95



“WONDERFUL, WEARABLE WIRE”

By Helwig

This book contains over 180 elegant and easy wire designs using the Olympus WigJig™. Five chapters are packed with designs as well as many tips and cross-references. The design pages include specific written directions, a complete wrapping diagram as well as a template showing exact number of pegs required and peg placement on your Olympus. This wirebound detailed book will make using your Olympus WigJig™ easy as well as enabling you to produce elegant designs with professional results.

Stock #
PUB-119.10 172 Pages \$39.95

WigJig sold on page 10.

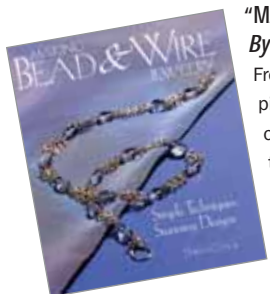

“MAKING BEAD AND WIRE JEWELRY”

By Dawn Cusick

From soft and graceful to bold and chunky, these 75 pieces of jewelry offer hours of pleasure for crafters of all skill levels. Merging traditional projects with today's latest materials, these earrings, necklaces, bracelets and eyeglass chains require a few simple tools and easy-to-learn techniques.

Stock #
PUB-118.00 128 Pages, Softbound \$18.95



“METAL CLAY BEYOND THE BASICS”

by Carol A. Babineau

"Metal Clay Beyond the Basics" by Carol Babineau aims to challenge and instruct you how to incorporate new techniques and materials into your work. 24 projects, 400 color photos and step-by-step instructions teach you how to integrate sterling silver, ceramics, and enamel into your metal clay projects and to use armatures, molds, tube rivets, and cold connections.

Stock #
PUB-162.00 96 Pages \$19.95



“KEUM-BOO ON SILVER”

by Celie Fago

Now revised and expanded, this book covers all aspects of Keum-boo, an ancient Korean technique in which thin sheets of gold are fused to silver. For metalsmiths, non-metalsmiths and those who work in PMC, the techniques described in this book provide a simple and relatively inexpensive way to add the luster of gold to silver work. This expanded edition includes new tips for cutting the gold and compares a torch and various hot plates and introduces the reader to the UltraLite kiln, a tool perfectly suited for Keum-boo. 90 color photos.

Stock #
PUB-151.00 64 Pages \$19.95



“METAL CLAY MAGIC”

By Nana Mizushima

"Metal Clay Magic" shows aspiring jewelry makers how to create eye-catching pieces with Metal Clay. This gorgeous full-color volume serves as a friendly, inviting introduction to metal clay and includes step-by-step photographs and concise instructions on working with metal clay, and more than 25 appealing projects that are easy to make. Includes beads, earrings, pendants, and unique origami projects. Inspiring gallery of projects from metal clay artists around the country.

Stock #
PUB-168.00 128 Pages \$21.95

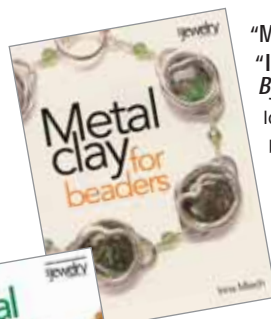

“METAL CLAY FOR BEADERS” & “INVENTIVE METAL CLAY FOR BEADERS”

By Irina Miech

Ideal for the beginning Metal Clay artists, these two books offer projects presented with step-by-step instructions and full-color photography. Beaders and jewelry artists can easily add detail to their pieces when they learn to use metal clay with "Metal Clay for Beaders". This guide to getting started with the material includes 14 projects which include making custom pendants, findings, rings, and more. "Inventive Metal Clay for Beaders" presents 18 new projects with a new focus: incorporating metal clay and beads into projects made from a variety of other materials.

Stock #
PUB-164.00 "Metal Clay for Beaders" 96 Pages \$19.95
PUB-166.00 "Inventive Metal Clay for Beaders" 112 Pages \$21.95



See our line of metal clay
tools and supplies!
Page 175-179

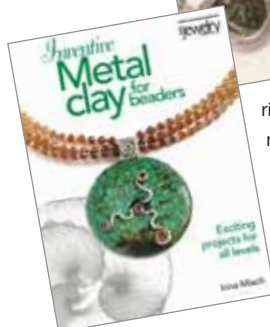

"STEP-BY-STEP BEAD STRINGING"*By Ruth F. Poris*

The title says it all in this manual by Ruth F. Poris. Step-by-step instruction and clear illustrations teach the user about choosing tools and supplies, single and multi-strand stringing, knotting and finishing several types of bead cords.

Stock #
PUB-113.00 113 Pages \$7.99

**"ADVANCED BEADWORK"***By Ruth F. Poris*

This beautiful book by Ruth F. Poris covers many beading techniques for both the beginner and advanced beadworker. Detailed illustrations and instructions teach the art of beadwork from simple to the most challenging projects. Poris covers topics such as off-loom weaving, loom weaving, needlepoint, embroidery, crochet, macrame and knitting.

Stock #
PUB-114.00 148 Pages \$14.99

**"THE BEST LITTLE BEADING BOOK"***By Wendy Simpson Conner*

A resource rich with thousands of illustrations. Includes step-by-step instructions for hundreds of projects, plus picture glossaries showing the differences between bead shapes and sizes, pliers, needles, stringing media and more. Chapters include designing and constructing jewelry, making your own beads with polymer clay, fused glass, etc., esoteric values of colors, shapes and other symbolism, starting a jewelry making business and more. A must-have for both beginners and pros.

Stock #
PUB-107.00 274 Pages \$24.95

**"THE BEADING ANSWER BOOK"***by Karen Morris*

No matter what size beads or style of beadwork you're working with, master teacher Karen Morris anticipates and resolves every quandary you might encounter. Whether you are a beginner trying to choose the right supplies for a simple necklace or an advanced crafter interested in mastering the details of crocheting with beads, this indispensable reference unravels more than 300 pesky problems. Illustrated instructions and insightful advice will help you work out your wire worries, tie graceful knots, weave your beads into stunning mini-tapestries, and conclude every masterpiece with the best clasp for the job.

Stock #
PUB-185.00 432 Pages \$14.95

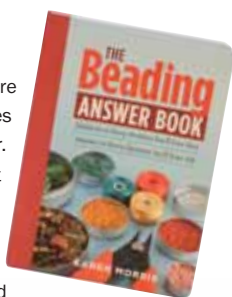
**"YOU MADE IT...NOW SELL IT!!!"***By Susie Bradford Edwards*

Absolutely everything you need to know before you make, sell or consign your jewelry to anyone. A source of expert guidance to help you enter today's hot and growing jewelry industry. "You Made It...Now Sell It!!!", covers the opportunities and the risks to be found by making and selling your unique creations. Detailed information includes pricing, wholesaling, business plans, financing and online selling.

Stock #
PUB-180.00 178 Pages \$19.95

**"CREATIVE WIRE JEWELRY"***By Kathy Peterson*

This comprehensive, how-to book combines wire wrapping with beads, glass, crystals and semi-precious stones. Beautifully done full color photographs show the details of important techniques for achieving beautiful results. This book is more than instructions - it is an inspiration!

Stock #
PUB-128.00 112 Pages \$19.95

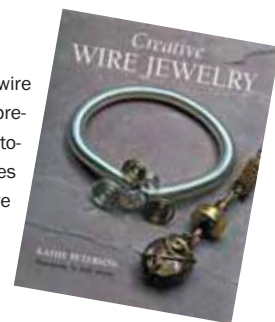
**"COMPLETE GUIDE TO MAKING WIRE JEWELRY"**

This collection of projects from Art Jewelry magazine introduces readers to basic wireworking tools and techniques. Readers learn to make wire jewelry using a variety of methods, including coiling, wire weaving, chain mail, wrapping, and shaping. Over 20 projects: necklaces, rings, bracelets, and more - demonstrates the different styles and effects that can be achieved with wire.

Stock #
PUB-133.00 119 Pages \$21.95

**"BEAD STRINGING INSTRUCTION BOOKLET"***By Griffin*

From Griffin, producer of high-quality bead cord, this is one of the best instruction booklets on the market. It is filled with detailed illustrations and explanations.

Stock #
PUB-110.00 32 Pages \$5.95

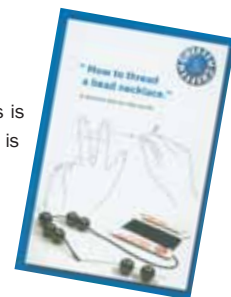

Necklace designed by
Fernando DaSilva.





"JEWELER'S RESOURCE BOOK" – REVISED EDITION
By Bruce G. Knuth

This book has become a standard reference in the jewelry industry. It is a unique and practical tool for the bench jeweler and jewelry student as well as the most complete counter reference available to the retail jeweler. Include: an extensive listing of gems and gem properties, complete lists of birthstones and birthstone alternatives, diagrams of more than forty gem cutting styles, diamond grading standards and gemstone care and much more.

Stock #		
PUB-120.00	134 Pages	\$21.95

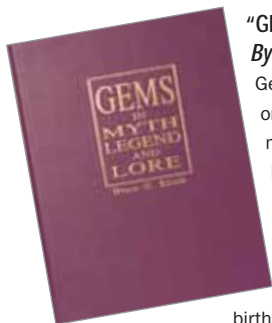

"GEMS IN MYTH LEGEND & LORE"
By Bruce G. Knuth

Gems have been prized for thousands of years, not only for their beauty and rarity, but their supposed mystic and magical qualities. This comprehensive book, in the tradition of ancient lapidaries, traces the use of gems in religion, medicine, magic, and astrology. Myths, legends, and lore gathered from numerous cultures are given for 46 different gems. Includes a history of gem literature, birthstones and planetary gems.

Stock #		
PUB-122.00	296 Pages	\$45.95

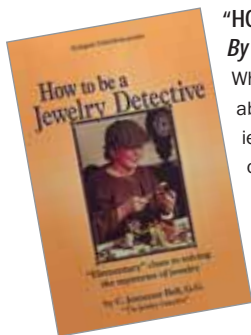

"HOW TO BE A JEWELRY DETECTIVE"
By Jeanenne Bell

Whether you are a dealer, collector or just curious about jewelry, this book can help you solve the mysteries of jewelry and jewelry elements. Jeanenne Bell, one of the leading authorities on antique jewelry, helps you find clues that tell if a piece is costume jewelry with rhinestones, or fine jewelry set with gemstones, how the back of a piece can help determine its age, what the marks and numbers on a ring, brooch, or pendant mean, how the "cut" of a stone can help you tell how old it is and much more.

Stock #		
PUB-127.00	167 Pages	\$18.95



"THE COMPLETE METALSMITH – Professional Edition"

"THE COMPLETE METALSMITH – Student Edition"

By Tim McCreight

Tim McCreight is a renowned metalsmith, designer, author, and teacher. His metalsmith books have become the standard text for classrooms and work shops. The **Student Edition** is perfect for hobbyists, students, and others who are just getting started in metalworking. It covers the basics including a section on metal clay. Durable plastic cover and spiral bound to lay flat. The **Professional Edition** is twice as large as the student edition. It covers the same material, but goes into greater depth with expanded information for serious artists. A rigid fabric cover and elastic band make this a place to store sketches and notes; more than a book, it's a practical tool for instruction and reference. Includes 1600 color drawings.

Stock #			
PUB-141.00	"The Complete Metalsmith – Professional Edition"	312 Pages	\$30.00
PUB-140.00	"The Complete Metalsmith – Student Edition"	160 Pages	\$15.00



"101 BENCH TIPS FOR JEWELERS"
By Alan Revere

Alan Revere now shares his most valuable bench tips and tricks in "101 Bench Tips for Jewelers." This book will help any jeweler speed production, improve quality, and raise profits at the bench. It covers all aspects of bench work, from soldering to stone setting, piercing to final polish. Discover how you can easily modify common bench tools to enhance productivity. Learn how household items, such as dental floss and paper clips, can become valuable bench aids. Find out how difficult repairs can become easy – with the help of a few tricks.

Stock #		
PUB-121.00	120 Pages	\$42.95

See the new Revere Plier Line on page 133.



"PROFESSIONAL RING REPAIR"
By Alan Revere

"Professional Ring Repair" was written by one of the country's foremost jewelry educators, Alan Revere. The only book of its kind, it documents the repair, alteration and restoration of rings in gold, silver and platinum. Follow fifteen ring repairs ranging from a simple stretching job to enlarging a bi-color shank, replacing a platinum half-shank and more. This book is essential for anyone doing repairs at the bench as well as storeowners, managers, sales associates and students.

Stock #		
PUB-126.00	128 Pages	\$44.95

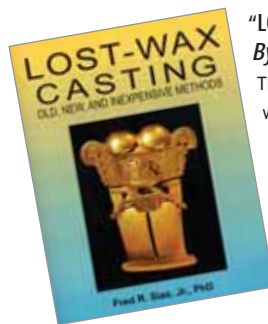

"LOST WAX CASTING"
By Dr. Fred R. Sias

This book is a basic introduction to lost-wax casting with emphasis on jewelry making. Designed to be used as a textbook and as a reference book, it is excellent for beginners as well as experienced casters. Heavy emphasis is placed upon understanding why things are done in a particular way, rather than simply presenting a set of "cook-book" rules that will always work.

Stock #		
PUB-135.00	214 Pages	\$22.95



"BASIC YEMENITE FILIGREE" - DVD
By Yehuda Tassa

This DVD, by Yehuda Tassa, teaches the ancient art of filigree. Yehuda began making filigree at age six, with his father, a well-known jeweler in Yemen. After retiring from a career in aerospace, Yehuda began doing filigree again. He teaches at art centers in Northern California, incorporating ancient and modern tools. Instructions are comprehensive and easy to understand. Total run time: 90 min.

Stock #		
PUB-520.01	90 minutes	\$69.00

RING SIZE CUTTER

The GRS Ring Size Cutter simplifies ring sizing by quickly removing an exact amount of ring shank. The cut is always parallel and precisely to size so soldering is neat and fast. You'll never have an uneven or wrong size cut. No more filing because these cuts are always parallel. Your ring sizing can be faster, easier and more profitable with this tool. Includes seven cutters US sizes 1/2 to 2 in 1/4" increments.

Stock #	Weight	
A. G04-642	4 1/2 lbs.	\$268.00



Faster easier and more precise ring sizing with the GRS Ring Size Cutter.

RING STRETCHER

Quickly enlarge rings with this easy to use, inexpensive tool. Simply tapping the end spreads the outer mandrel and stretches the ring. For rings size 6 or larger. Not for use on stone-set rings. 6 1/2" length.

Stock #		
B. RST-720.00		\$15.45

TABLE TOP RING STRETCHER

Stretches rings with mountings when other stretchers cannot be used. Supplied with 17 rollers in wood storage box to accommodate all ring sizes. Easy to use. Replacement roller set also available.

Stock #	Description	Weight	
C. RST-740.00	Ring Stretcher	4 lbs.	\$54.25
RST-740.17	Replacement Roller Set - 17 pc		\$31.50



With a tap of a hammer, rings can be quickly and economically stretched. We recommend our rawhide mallets on page 102.

RING STRETCHER

Italian made ring stretcher assures the finest quality with six-spline mandrel, graduated in U.S. sizes 3 1/2 to 15. This compact, upright style saves much needed bench space. Economical, yet very durable tool for ring stretching. Easily and securely bolts to bench.

Stock #	Description	Weight	
D. RST-750.00	Ring Stretcher	13 1/2 lbs.	\$199.15



RING STRETCHER with REDUCTION WHEEL

This premium Italian ring stretcher both reduces and enlarges rings up to size 15. The highly polished six-spline mandrel is graduated in U.S. sizes for smoothly and accurately enlarging rings. The reversible base plate has 16 smoothly-honed reduction dies which will not scratch and allows for reducing bands up to 12mm wide by compression. Italian-made, upright, compact model assures the finest quality.

Stock #	Description	Weight	
E. RST-751.00	Ring Stretcher	23 1/2 lbs.	\$260.00



After reducing or enlarging rings, always verify correct size with a quality calibrated ring mandrel. See page 113 for our selection of mandrels.

PRICES ARE SUBJECT TO CHANGE WITHOUT NOTICE.
Please note prices are subject to change without notice due to fluctuations in foreign exchange rates, raw material costs, duties and other factors beyond our control.





A

KIRKLAND RING CLAMP/HOLDER

The Kirkland clamp/holder clamps from the outside for filing, polishing and stone setting and can also be used to clamp other jewelry. Unlike most clamps, it can also hold rings from the inside for total circumference polishing and buffing. The metal construction of high strength aluminum alloy conducts heat away from the ring. Holds ring sizes 1-13. Made in the USA.

Stock #	Length	Maximum Opening	
A. RCL-535.00	5 ³ / ₈ "	14mm	\$14.95



B

KIRKLAND EXTERNAL RING CLAMP

The Kirkland External Ring Clamp, like its better known sibling, is made of cast aluminum for years of service. This clamp holds a ring externally which allows the user to file, grind or polish the inside. Jaws are lined with thick leather and slightly concave so they will not scratch gold, silver or other precious metals. Made in the USA.

Stock #	Length	Maximum Opening	
B. RCL-537.00	6"	25mm	\$22.95



C

HARDWOOD RING CLAMP

This high-quality wooden ring clamp has leather jaws for holding rings and other objects while filing, mounting, etc. The standard of the industry.

Stock #	Length	Maximum Opening	
C. RCL-650.00	6"	15mm	\$6.80



D

NYLON RING CLAMP

Nylon Ring Clamp has leather lined jaws, round and flat ends, for securely holding rings and other objects without marring. New and improved band for exceptional holding power.

Stock #	Length	Maximum Opening	
D. RCL-655.00	6"	15mm	\$6.20



F



E

SWISS STYLE RING CLAMP

Our ring clamp is Swiss style and made primarily of aluminum. The jaws are leather lined (the preferred material for holding rings). The handle features a cushion grip with excellent properties. It is very slip resistant but not too soft. The jaws are "pulled" closed by the knob at the lower end, which cannot slip as conventional wooden ring clamps do. Maximum opening is just over 1/4" (7.50mm). Length 6³/₄" (175mm).

Stock #	Description	
E. RCL-507.02	Swiss Style Ring Clamp with Custom Bench Pin	\$42.95
F. RCL-507.00	Swiss Style Ring Clamp	\$38.95
BPN-107.10	Bench Pin w/ Cutout	\$4.15

Our "Cutout" or "V-Slot" Bench Pins are shaped for instant use with your ring clamps when working at the bench. See our complete line of Bench Pins on page 28.



SMALL ROUND HEAD RING CLAMP

Only 5" long and narrower for smaller work or smaller hands. You get infinitely more control and "feel" with this clamp. Thick leather jaws and hardwood for long life.



Stock #	Length	Maximum Opening	
A. RCL-665.00	5"	12mm	\$6.45



PARALLEL JAW RING CLAMP

This ring clamp is inexpensive, but effective with two jaws that stay parallel when the brass nut is tightened. Made of wood with nice leather jaws and a metal collar to keep everything in place.

Stock #	Length	Maximum Opening	
B. RCL-669.00	6"	8mm	\$7.95



MAHOGANY RING CLAMP

Made of mahogany for strength, feel and long life, this clamp also features a metal pivot and extra strong band. Best of all, jaws are lined with extra thick leather to hold rings better and heal faster. Jewelers will love the feel of this clamp - the quality is simply the best available.

Stock #	Length	Maximum Opening	
C. RCL-652.00	6"	15mm	\$7.95



MAHOGANY RING CLAMP with ROTATING METAL HOLDER

Our mahogany ring clamp and newly developed bench "pin" allows the user to rotate rings and other items in virtually any direction for ease of work. Mahogany is the best wood available and this clamp features thick leather jaws for maximum grip, along with a strong metal axle for long life. The ridge near the end keeps the clamp secure in the strong metal yoke. The "pin" or yoke is made of 3/8" steel rod. When it is inserted into the bench it will not wobble, but turns "on-axis" for a solid feel and maximum control. With butcher block benches, simply drill a 3/8" hole 3 1/2" deep and insert the pin. You will get years of life from this fine set.

Stock #	Description	
D. RCL-653.20	Mahogany Ring Clamp w/ Metal Holder	\$21.75
RCL-660.10	Metal Holder Only	\$13.60



MAHOGANY RING CLAMP with COLLAR

Our newest and best ring clamp offers the user greater reliability than other ring clamps. The "collar" feature incorporated into the design allows the user to station it in the v-cut of a bench pin for greater stability and less effort. This clamp is slightly smaller in diameter and fits perfectly into our BPN-106.50 custom mahogany bench pin. Features include thick leather jaws and a thick brass band with metal axle. Made of red Philippine straight-grained mahogany.

Stock #	Description	
E. RCL-653.00	Mahogany Ring Clamp	\$11.95
F. RCL-653.02	Mahogany Ring Clamp w/ Custom Bench Pin	\$8.95
BPN-106.50	Mahogany Bench Pin Only	\$4.95



WOODEN RING CUTTING JIG

Our wooden ring cutting jig is economical and handy. Just 5 5/8" long, it fits onto most any bench or table. Made of hardwood, this jig will not scratch precious metals and assures a straight, accurate cut every time.



Stock #	Length	
G. BPN-110.00	5 5/8"	\$1.85





A

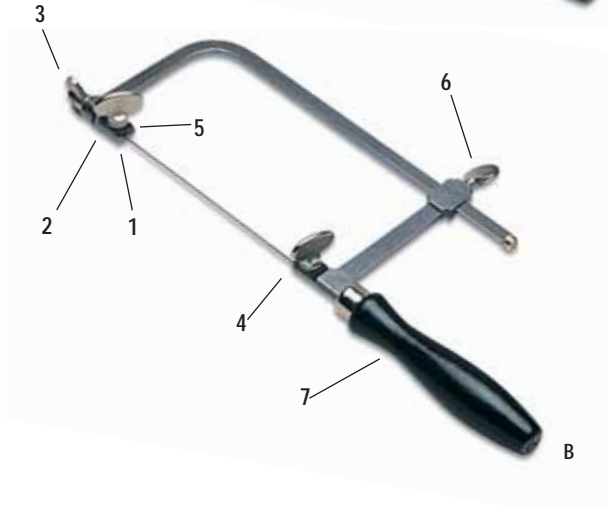

B

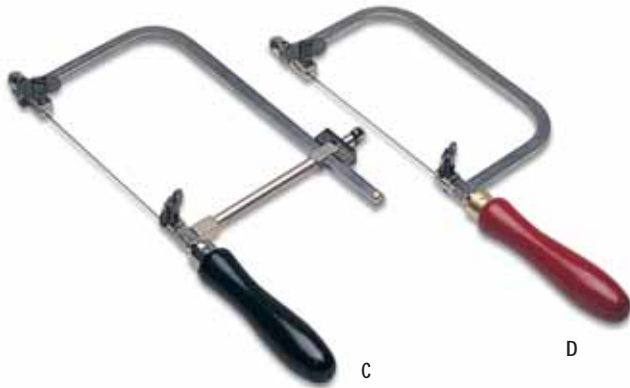

C

D

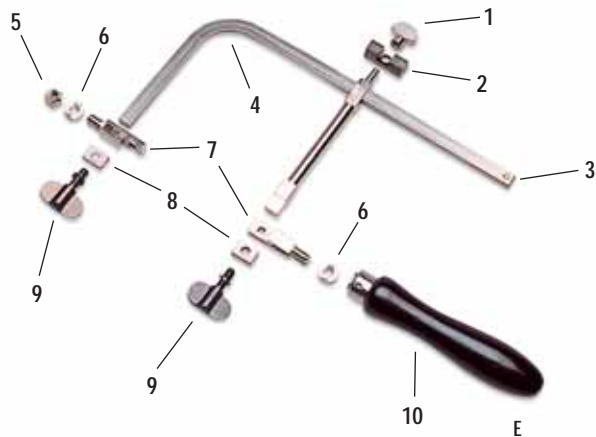

E

A. DELUXE SAWFRAMES

High-quality, well-balanced frames are strongly constructed with hardwood handles. Blades are firmly held by serrated lugs. The frames are adjustable to accommodate broken blades. You'll get an accurate cut with our German-made saws.

Stock #	Description	
SAW-312.00	2 1/4" (60mm)	\$16.25
SAW-313.00	3" (80mm)	\$17.80
SAW-314.00	4" (100mm)	\$18.20
SAW-315.00	5" (125mm)	\$19.35
SAW-316.00	6" (150mm)	\$20.35
SAW-318.00	8" (200mm)	\$22.60

B. DELUXE SAWFRAMES with TENSION SCREWS

These are the same high-quality frames as our Deluxe Sawframes, but with the added feature of a tension screw to adjust the blade to the exact tension desired. German-made.

Stock #	Description	
SAW-333.00	3" (80mm) w/ Tension Screw	\$19.90
SAW-334.00	4" (100mm) w/ Tension Screw	\$20.95

Replacement Parts for German Sawframes

Stock #	Description	
1. SAW-310.01	Wing Screw (for holding blades)	\$1.60
2. SAW-310.02	Blade Block (including wing nut, washer, nut & pad)	\$5.60
3. SAW-310.05	Blade Tension Wing Nut (for tightening blades)	\$1.60
4. SAW-310.06	Washers for Blade (round and rectangle)	\$1.60
5. SAW-310.08	Blade Pad (bolt)	\$2.80
6. SAW-310.09	Frame Wing Screw	\$1.60
7. SAW-310.10	Handle	\$1.60

C. PREMIUM FRENCH SAWFRAMES

Deluxe sawframes feature rigid construction and fine balance for the serious craftsman. Made of the finest materials, every part is replaceable, including the handle which unscrews. If you haven't found the right sawframe, then this is the one for you – not too heavy, not too light, just right to make sawing easy.

Stock #	Description	
SAW-351.00	2 1/4" (60mm)	\$36.23
SAW-352.00	2 3/4" (70mm)	\$36.82
SAW-352.50	3" (80mm)	\$37.41
SAW-353.00	3 3/4" (95mm)	\$37.82
SAW-355.00	5" (125mm)	\$39.05
SAW-356.00	6" (150mm)	\$40.42

D. DELUXE NON-ADJUSTING SAWFRAME

Why hasn't this happened before? The best solid, non-adjustable frame made. Removing the slide adjustments means less wobble, and since all blades are the same length anyway, the adjustment is unnecessary. This is another of the premium family of sawframes and all parts are replaceable. Features serrated lugs to hold blades tightly in place. 3" depth with perfect balance. Made in France.

Stock #	Description	
SAW-362.00	3"	\$33.60

E. Replacement Parts for Premium French Sawframes

Stock #	Description	
1. SAW-350.01	Frame Nut	\$2.65
2. SAW-350.02	Frame Nut/Bolt/Block	\$2.65
3. SAW-350.03	Frame Brass Pin	\$0.21
4. SAW-350.04	Frame Only (must specify size of sawframe)	\$4.40
5. SAW-350.05	Locking Nut for Blade Block	\$0.90
6. SAW-350.06	Washer for Blade Block	\$0.90
7. SAW-350.07	Blade Block	\$3.70
8. SAW-350.08	Blade Pad	\$1.25
9. SAW-350.09	Blade Nut with Washer	\$3.95
10. SAW-350.10	Handle	\$3.70

A. GERMAN-STYLE SAWFRAMES

Our German-style sawframes offer terrific value, while maintaining our high quality standards. Made of high carbon steel, all features are precisely the same as our German Deluxe models. Each frame also features hardwood handles, serrated lugs to tightly hold blades, large thumbscrews and excellent alignment for straight and accurate cutting.

Stock #	Description	
SAW-343.00	3" (80mm)	\$9.65
SAW-343.50	3" (80mm) with Tension Screw	\$11.40
SAW-344.00	4" (100mm)	\$10.70
SAW-345.00	5" (120mm)	\$12.45
SAW-346.00	6" (150mm)	\$13.50

RIGID FIXED FRAME

Most people don't use broken saw blades anyways, so why pay more for an adjustable saw frame when this one will work perfectly well? Made of high-grade steel with a comfortable, hardwood handle, blades are held perfectly straight for accurate cutting. Because it is one piece it will maintain consistent tension.

Stock #	Description	
B. SAW-652.00	3"	\$6.75

ECONOMY SAWFRAME

This sawframe offers durable construction, a hardwood handle, large thumb-screws and a 3" depth. It's an excellent value.

Stock #	Description	
C. SAW-650.00	3"	\$8.25

D. SPIRAL WAX SAWBLADES

Unique design for cutting wax, plastic, rubber, shell, plaster and more. Teeth spiral up the blade to permit cutting in all directions. Made in Germany. Sold per gross.

Stock #	Cut	
SAW-120.05	2/0	\$21.95
SAW-120.06	0	\$21.95
SAW-120.07	1	\$21.95
SAW-120.08	2	\$21.95
SAW-120.09	3	\$21.95
SAW-120.10	4	\$21.95

E. DIAMOND SAWBLADES

We offer you another value engineered product, our diamond-coated sawblades. Made by electroplating diamond particles onto piano wire, our diamond blades are the best quality available at prices well below the competition. Our manufacturer offers a generous supply of diamond for long life and quick cutting. Blades come individually packaged and are 53/8" long to fit existing sawframes. Great for glass, ceramic and stones. Other grits available upon request.

Stock #	Description	
SAW-270.60	60 Grit (Coarse)	\$8.95
SAW-271.00	100 Grit (Medium/Coarse)	\$8.95
SAW-271.20	120 Grit (Medium)	\$8.95
SAW-271.40	140 Grit (Medium/Fine)	\$8.95

MITRE SAW SET

A handy saw for wood, plastic or other non-metallic materials. The mitre box assures exact 90° or 45° angles for perfect corners every time. Blades are interchangeable. The box is made of extruded aluminum. Great for sawing wax ring tubes!

Stock #	Description	
F. SAW-670.00	Mitre Set (1 1/2" saw, box and handle)	\$14.45
SAW-670.01	Mitre Box	\$6.95
SAW-670.05	Mitre Saw, 3/4" wide blade	\$2.95
SAW-670.10	Mitre Saw, 1 1/2" wide blade	\$3.95

Quality German-style frames
are a great value!

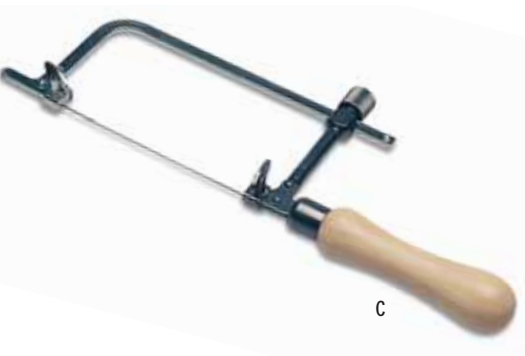
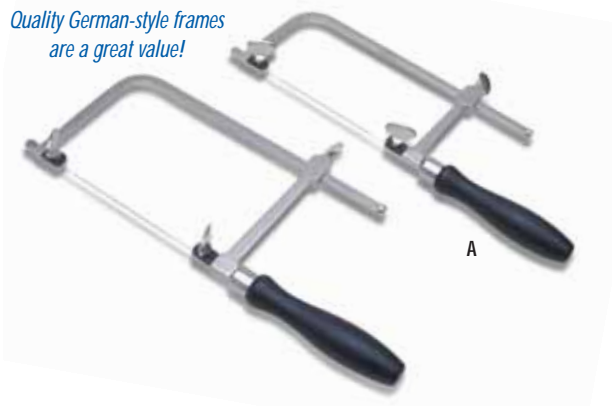



Use Cut Lube to
extend the life of
your sawblades –
page 44



New!



A. CROCODILE SAWBLADES

A blade you'll love at a price you'll adore. A crocodile has sharp, biting teeth and so do Crocodile sawblades. Made in Switzerland of the finest steel, by the leading manufacturer, we guarantee your satisfaction. Crocodiles are round backed with precisely milled teeth for accuracy and ease of cutting. Combined with the perfect temper, Crocodile blades will perform up to your most demanding requirements. Sold per gross.

Stock #	Cut		Stock #	Cut	
SAW-550.01	6/0	\$24.95	SAW-550.07	1	\$19.95
SAW-550.02	5/0	\$23.45	SAW-550.08	2	\$19.95
SAW-550.03	4/0	\$21.95	SAW-550.09	3	\$19.95
SAW-550.04	3/0	\$19.95	SAW-550.10	4	\$19.95
SAW-550.05	2/0	\$19.95	SAW-550.11	5	\$21.95
SAW-550.06	0	\$19.95	SAW-550.12	6	\$23.45

B. FORME d'ART

A good inexpensive blade for the novice and hobbyist. We are proud of the quality of Forme d'Art blades at an exceptional price. Sold per gross.

Stock #	Cut		Stock #	Cut	
SAW-265.00	8/0	\$6.95	SAW-265.07	1	\$6.95
SAW-265.01	6/0	\$6.95	SAW-265.08	2	\$6.95
SAW-265.02	5/0	\$6.95	SAW-265.09	3	\$6.95
SAW-265.03	4/0	\$6.95	SAW-265.10	4	\$6.95
SAW-265.04	3/0	\$6.95	SAW-265.11	5	\$6.95
SAW-265.05	2/0	\$6.95	SAW-265.12	6	\$6.95
SAW-265.06	0	\$6.95	SAW-265.14	8	\$6.95

C. RELENTLESS® SAWBLADES

Our Relentless® blades are manufactured in Switzerland from the highest quality steel on the most modern equipment. The result is a blade with flexibility and an unexcelled edge for cutting gold, silver and other metals. Relentless® blades are extra long lasting because they are electronically tempered and are easier to use because they don't wander. Teeth are perfectly angled, uniform and straight. We chose Relentless® "Golden Extras" because they are state-of-the-art to meet all of your cutting requirements. Sold per gross.

Stock #	Cut		Stock #	Cut	
SAW-400.01	6/0	\$35.35	SAW-400.07	1	\$26.60
SAW-400.02	5/0	\$31.50	SAW-400.08	2	\$26.60
SAW-400.03	4/0	\$28.95	SAW-400.09	3	\$26.60
SAW-400.04	3/0	\$26.60	SAW-400.10	4	\$26.60
SAW-400.05	2/0	\$26.60	SAW-400.11	5	\$28.95
SAW-400.06	0	\$26.60	SAW-400.12	6	\$31.50

D. ANTILOPE SAWBLADES

Saw for less! Perhaps the most inexpensive blades in the world! Sounds crazy, but because of Antilopes' quality, you'll get more cuts, spend less time changing blades due to breakage, experience less dulling and truer cutting. This equates to a cheaper blade in the long run, even though you pay a little more initially. So make the leap to Antilope sawblades today! Sold per gross.

Stock #	Cut		Stock #	Cut	
SAW-300.00	8/0	\$38.85	SAW-300.06	0	\$25.12
SAW-300.01	6/0	\$32.25	SAW-300.07	1	\$25.12
SAW-300.02	5/0	\$29.47	SAW-300.08	2	\$25.12
SAW-300.03	4/0	\$27.24	SAW-300.09	3	\$25.12
SAW-300.04	3/0	\$25.12	SAW-300.10	4	\$25.12
SAW-300.05	2/0	\$25.12	SAW-300.12	6	\$29.47

ROTATING SAWBLADE HOLDER

Keep sawblades organized on your bench. This nicely finished hardwood holder has fourteen holes to keep sizes separate with a rotating base to keep them easily at your fingertips.

Stock #	Size	
E. HOL-104.00	7" x 4 1/2"	\$24.95

CARAT SCALE

Small and very accurate, this pocket scale 11.5cm x 6.5cm x 2.1cm (4⁵/₈" x 2³/₈" x 1¹/₄"), weighing a mere 1.20 grams (4 oz.) is the one we've been waiting for.

- Weighs in carats (0.01), dwt (0.001), grains (0.02), and grams (0.0001) and ozt (.0001).
- Maximum weight carats = 50; grams = 10.
- Tare function plus "add-up" capabilities.
- Protective lid also enhances accuracy in carat mode.
- Uses four AAA batteries which are included.
- Comes in leatherette protective box with 5 gram and 10 gram calibration weights plus a small tweezer for stones.

This is simply the best small scale we've ever seen, complete with full directions and at a very affordable price.

Stock #	
A. SCL-300.55	\$69.95



GEMINI-20 GRAM/CARAT SCALE

A portable precision scale with incredible accuracy weighs up to 20 grams in 0.001g increments or 100 carats in 0.005ct accuracy.

- Weighs in g, oz, ct, ozt, dwt, gn.
- Protective clear cover.
- Includes carrying case, weighing pan, tweezers and calibration weight.
- 10 year limited warranty.

Stock #	
B. SCL-310.00	\$59.95



DIGITAL TABLETOP BALANCE/COUNTING SCALE

Portable, with its compact slim design, our larger scale offers a 1000g capacity x 0.1g, digital auto calibration and four different weighing functions (g/ct/gn/oz). The scale has a 5³/₄" stainless steel platform and operates on 4 AA batteries or AC adapter. It also offers parts counting capabilities and memory functions. One year warranty.

- High quality strain gauge load cell.
- Durable with overload protection.
- 4 weighing modes convertible.
- Counting function embedded.
- Large high contrast LCD display.
- Removable stainless steel platform.
- Powered by both batteries and AC adapter.

Stock #	Size	
C. SCL-292.50	8 ¹ / ₂ " x 6 ³ / ₄ " x 1 ¹ / ₂ "	\$80.00



Can be used as a counting scale.



CALIBRATION WEIGHTS

Precision calibration weights made to exacting standards to ensure consistent density. Available in 100g or 250g.

Stock #	Description	
D. SCL-901.00	100g Calibration Weight	\$10.95
E. SCL-902.50	250g Calibration Weight	\$12.95

CONVERSION TABLE		
Convert From	To	Multiply By
Avoir.ounces	troy ounces	.91146
Avoir.ounces	grams	28.3495
Avoir.ounces	dwt	18.2291
Carats	grains	3.0865
Carats	dwt	.12860
Carats	grams	.2
Pennyweight (dwts)	carats	7.776
Pennyweight (dwts)	grams	1.5552
Pennyweight (dwts)	troy ounces	.05
Pennyweight (dwts)	avoir.ounces	.05486
Grains	carats	.324
Grains	grams	.0648
Grains	dwt	.04167
Grams	carats	5.0
Grams	dwt	.64301
Grams	troy ounces	.03215
Troy Ounces	grams	31.1035
Troy Ounces	avoir.ounces	14.583
Troy Ounces	dwt	20
Troy Ounces	avoir.pounds	.06857



A

B



C



D

POCKET SCALES

Two scales in 250 gram or 600 gram capacity at exceptional pricing. Both are excellent quality and your satisfaction is guaranteed.

- Excellent accuracy and reliability.
- Flip top covers to protect the load cell when not in use.
- Weighs in grams, ounces, dwt, and ozt modes.
- Auto power off feature.
- Lightweight with auto calibration and full tare capacity.
- Powered by 2 AAA batteries.

Stock #	Description	
A. SCL-300.20	250 x 0.1 grams	\$32.95
B. SCL-300.60	600 x 0.1 grams	\$33.95

600 GRAM SCALE

You want capability? We've got capacity and at a price everyone can afford. Our new 600 gram scale with a superior load cell gives you the capacity you need.

- 600 grams by 0.1 gram.
- Auto shut-off.
- Modes: gram, oz, dtw, ozt.
- Tare function.
- Leatherette case.
- Transparent cover which can also be used as a tray.
- Powered by 4 AAA batteries.

The clear protective cover makes an excellent tray for loose parts, plus this scale has a modern design and is truly pocket size. Measures 6" x 3¹/₈" x 3³/₄" (150 x 80 x 18mm) and weighs just 4.8oz.

Stock #		
C. SCL-305.00		\$34.95

MINISCULE SCALE

Dalman Miniscule Scale – the smallest scales you've ever see! Compact but accurate with capacity of 300g x 0.1g for the gram scale and 250 carats x .05 for the carat scale.

- 2⁷/₈" x 1⁷/₁₆" x 1¹/₂" (72 x 36 x 12mm), weight: 1.6 oz.
- Full tare function/calibration.
- Backlit LCD display.
- Auto shut-off – overload protected.
- Runs on one CR2032 battery – included.
- Case and full instructions included; cover doubles as a tray.
- Five year warranty.

Stock #	Description	Capacity	
D. SCL-285.00	Miniscule Gram Scale	300g x 0.1g	\$29.95
SCL-286.00	Miniscule Carat Scale	250 carats x .05 / 50g x 0.01g	\$37.95

New!

PRESIDIUM



E

PRESIDIUM 100 CARAT SCALE

The Presidium 100 Carat Scale is the latest innovation of carat weighing technology, utilizing Advanced Circuitry Design and Surface Mount Technology (SMT). This portable carat scale promises reliability and consistency for long periods of continuous usage. Designed specially for jewelry traders on the move by the leading maker of gemological instruments, its compact size and rugged build allow for easy-to-travel usage and durability. Combining precision accuracy and compact designing, it is the perfect scale for all jewelers. One year warranty.

- 100 carats (20g) weighing capacity.
- Selection mode: gram/carat/ozt/grain.
- Graduation: 0.01ct/0.002g/0.0001ozt/0.05gr.
- Continuous operating without shutting-off. Does not require recalibrating during operation.
- Automatic power down after 10 minutes from the last measurement.
- Powered by 4 AAA battery.
- Dimension: 114mm x 152mm x 41mm.

Stock #	Description	
E. SCL-381.00	100 Carat	\$275.80

SET-SCREW SCREWDRIVER SET IN ROTATING STAND

This premium set of nine color-coded set-screw screwdrivers includes 19 spare blades and two extra set-screws. Blades are held tightly with set-screws. Screwdrivers range from 0.60 – 3.00mm. The stand gives easy access for busy repairmen. Made in Europe. Individual blades and screwdrivers below.

Stock #	Description	
A. SCR-980.00	Set of 9 in Rotating Stand	\$53.80
SCR-990.00	Replacement Blade Set (3 each of 9 sizes)	\$13.00
SCR-990.02	9 pc Blade Set for Set-Screw Type	\$4.55

Individual Screwdrivers

Stock #	Description	Color	
SCR-980.60	0.60mm	Pink	\$4.45
SCR-980.80	0.80mm	Yellow	\$4.45
SCR-981.00	1.00mm	Black	\$4.45
SCR-981.20	1.20mm	Red	\$4.45
SCR-981.40	1.40mm	Gray	\$4.45
SCR-981.60	1.60mm	Purple	\$4.45
SCR-982.00	2.00mm	Green	\$4.45
SCR-982.50	2.50mm	Blue	\$4.45
SCR-983.00	3.00mm	Brown	\$4.45
ZZSD18978V	Replacement Screw for Set-Screw Screwdrivers		\$0.47



SET-SCREW SCREWDRIVER SET IN WOODEN BOX

The same high-quality screwdrivers included in the SCR-980.00 set. The screwdrivers and spare blades come complete in a beautifully finished hardwood box. This set is great for those on the move and can be stored when not in use.

Stock #	Description	
B. SCR-989.00	Set of 9 in Wooden Box	\$58.95
SCR-990.00	Replacement Blade Set (3 each of 9 sizes)	\$13.00



B

SIX PIECE SET-SCREW SCREWDRIVER SET

Our color-coded six piece set features the following sizes: 0.80, 1.00, 1.20, 1.40, 1.60 and 2.00mm. Like our well-known SCR-980.00, this set features set-screw type screwdrivers. Packaged in a handy, reusable storage pouch.

Stock #	Description	
C. SCR-980.01	Set of 6 in Pouch	\$20.25
SCR-399.00	6 pc Replacement Blade Set (1 of each size)	\$2.81



C

D. BLADES FOR SET-SCREW TYPE SCREWDRIVERS

Individual Blades (3 per bag)

Stock #	Description	
SCR-990.60	0.60mm Blade	\$1.29
SCR-990.80	0.80mm Blade	\$1.29
SCR-991.00	1.00mm Blade	\$1.29
SCR-991.20	1.20mm Blade	\$1.29
SCR-991.40	1.40mm Blade	\$1.71
SCR-991.60	1.60mm Blade	\$1.71
SCR-992.00	2.00mm Blade	\$1.71
SCR-992.50	2.50mm Blade	\$1.83
SCR-993.00	3.00mm Blade	\$1.83
ZZSD18978V	Replacement Screw for Set-Screw Screwdrivers	\$0.47

Replacement Blade Sets

Stock #	Description	
SCR-399.00	6 pc Replacement Blade Set for SCR-980.01 (Includes 1 each size: 0.80, 1.00, 1.20, 1.40, 1.60, 2.00mm)	\$2.81
SCR-399.01	18 pc Blade Set for SCR-980.01	\$6.43
SCR-990.00	27 pc Replacement Blade Set for SCR-980.00 and SCR-989.00 (Includes 3 each size: 0.60, 0.80, 1.00, 1.20, 1.40, 1.60, 2.00, 2.50, 3.00mm)	\$13.00
SCR-990.02	9 pc Blade Set for Set-Screw Type	\$4.55



D



A



B



C



EXCLUSIVE

D



Replacement blades
are packaged in
bags of three.



E



F

REVERSIBLE-BLADE SCREWDRIVER SETS

A very popular series of screwdrivers that features color-coded hex heads and reversible blades. Blades are tempered and finely ground to exact specifications. Individual replacement blades are packaged in bags of three. Made in France. Individual blades and screwdrivers listed below.

Stock #	Description	
A. SCR-730.00	Set of 6 Screwdrivers in Pouch (sizes #4 - #9)	\$25.13
B. SCR-730.01	Set of 7 Screwdrivers in Pouch (sizes #3 - #9)	\$27.42
C. SCR-730.02	Set of 7 Screwdrivers in Box (sizes #3 - #9)	\$28.05
SCR-740.00	Replacement Blade Set for SCR-730.00 (18 pc Set, 3 each size: #4 - #9)	\$8.59
SCR-740.01	Replacement Blade Set for SCR-730.01 and SCR-730.02 (21 pc Set, 3 each size: #3 - #9)	\$10.25
SCR-740.02	Replacement Blade Set for SCR-730.01 (7 pc Set, 1 each size: #3 - #9)	\$3.51

REVERSIBLE-BLADE SCREWDRIVERS IN WOODEN STAND

The same premium reversible-blade screwdrivers as our SCR-730.00 set - sizes #4 through #9. Blades are tempered and finely ground to exact specifications. The hardwood stand offers just the right degree of angle to make seeing and choosing the correct screwdriver as easy as possible. Plus, the stand comes with a convenient storage compartment on the top for spare blades. One set of spare blades is included.

Stock #	Description	
D. SCR-373.00	Set of 6 in Wooden Stand (sizes #4 - #9)	\$32.00
SCR-374.00	Replacement Blade Set (6 pc Set, 1 each size #4 - #9)	\$3.15

Individual Reversible Blade Screwdrivers

Stock #	Screwdriver No.	Color	Size	
SCR-730.03	#3	Orange	1.50mm	\$3.63
SCR-730.04	#4	Black	1.30mm	\$3.63
SCR-730.05	#5	Green	1.20mm	\$3.63
SCR-730.06	#6	Brown	1.00mm	\$3.63
SCR-730.07	#7	Red	0.80mm	\$3.63
SCR-730.08	#8	Silver	0.70mm	\$3.63
SCR-730.09	#9	Blue	0.60mm	\$3.63

Replacement Blades (Bag/3)

Stock #	Screwdriver No.	Color	Size	
SCR-740.03	Blade for #3	Orange	1.50mm	\$1.43
SCR-740.04	Blade for #4	Black	1.30mm	\$1.43
SCR-740.05	Blade for #5	Green	1.20mm	\$1.43
SCR-740.06	Blade for #6	Brown	1.00mm	\$1.43
SCR-740.07	Blade for #7	Red	0.80mm	\$1.43
SCR-740.08	Blade for #8	Silver	0.70mm	\$1.43
SCR-740.09	Blade for #9	Blue	0.60mm	\$1.43

FIXED-BLADE SCREWDRIVER SET

Handy three piece fixed blade screwdriver set offers the most popular sizes in a convenient pouch. European made screwdrivers. Set includes sizes 1.0mm, 1.2mm and 1.6mm.

Stock #	Description	
E. SCR-260.03	Set of 3 (Sizes: 1.00, 1.20, 1.60mm)	\$6.75

DELUXE FIXED-BLADE SCREWDRIVERS

European fixed-blade screwdrivers with color-coded bands to indicate sizes. Precisely ground, tempered blades with nicked handles and hex heads. Excellent quality matched with economy makes these a winner.

Stock #	Description	
F. SCR-260.00	Set of 6 in Pouch (Sizes: 0.80, 1.00, 1.20, 1.40, 1.60, and 2.00mm)	\$14.55

Individual Screwdrivers

Stock #	Size	Color	
SCR-260.80	0.80mm	Yellow	\$2.04
SCR-261.00	1.00mm	Black	\$2.04
SCR-261.20	1.20mm	Red	\$2.04
SCR-261.40	1.40mm	Gray	\$2.04
SCR-261.60	1.60mm	Violet	\$2.37
SCR-262.00	2.00mm	Green	\$2.37

POCKET SCREWDRIVER SETS

This pen size aluminum holder with nicely finished anodized barrel and pocket clip has a built-in chuck made of steel and pressed into the barrel to firmly hold screwdriver blades and prevent turning. The screwdriver blades are made of heat treated alloy steel for strength and durability and may be stored inside the barrel. Length 3³/₄".

Stock #	Description	Handle Dia.	
A. SCR-101.00	3 pc Set (Straight: 1.0, 1.4mm; Phillips: 2.0mm)	3/8"	\$14.25
B. SCR-102.00	5 pc Set (Straight: 1.8, 2.0, 2.5mm; Phillips: 2.0, 2.5mm)	3/8"	\$17.95
SCR-104.00	5 pc Set (Straight: 1.0, 1.4, 2.0mm; Phillips: 1.4, 2.0mm)	3/8"	\$18.85
C. SCR-106.00	5 pc Set (Straight: 2.0, 2.5, 3.2mm; Phillips: 2.5, 3.0mm)	1/2"	\$18.95

Replacement Blade Sets

Stock #	Description	
SCR-101.10	3 pc Replacement Blade Set for SCR-101.00	\$6.69
SCR-102.10	5 pc Replacement Blade Set for SCR-102.00	\$9.40
SCR-104.10	5 pc Replacement Blade Set for SCR-104.00	\$10.98
SCR-106.10	5 pc Replacement Blade Set for SCR-106.00	\$11.20

PHILLIPS SCREWDRIVERS

Handy European made Phillips screwdrivers feature one of the smallest sizes available (1.20mm), knurled handles, hex heads and tempered steel blades. Excellent for electronics, computer and camera repair.

Stock #	Description	Length	
D. SCR-830.00	Set of 4	4 1/2"	\$17.40

Individual Screwdrivers

Stock #	Description	Color	
SCR-831.20	1.20mm	Grey	\$4.35
SCR-831.50	1.50mm	Violet	\$4.35
SCR-832.00	2.00mm	Green	\$4.35
SCR-832.50	2.50mm	Blue	\$4.35

MINI DELTA SCREWDRIVER SET

Our value engineered screwdriver set features three straight blade and three Phillips screwdrivers, all in small sizes. This may be the handiest set available today for small jobs. Another EURO TOOL exclusive. Set includes one each of the following:

Phillips: 1.4mm, 1.6mm, 2.0mm

Straight: 1.2mm, 1.4mm, 1.6mm

Stock #	Description	
E. SCR-900.00	Set of 6	\$4.95

SCREWDRIVER

Originally designed and widely used in the optical trade, this set is perfect for jewelers, watchmakers, hobby, camera and home use. Aluminum knurled body for a sure grip and hex swivel head that won't roll off your bench. Four reversible blades for a total of eight tips, four Philips and four straight blades. Blades easily snap in and out of handle. Sizes include: Philips 000, 00, 0 and 1; straight: 1.6, 2.0, 2.4 and 3.2mm for an excellent range. The screwdriver is a great combination of quality and bargain.

Stock #		
F. SCR-940.00		\$7.95

TOOL STAND with SHARPENER

Polished hardwood stand offers convenient and safe storage for your slim tools such as carvers, screwdrivers, awls, etc. With a built-in sharpening stone and side storage for small parts such as blades, set-screws, this stand holds up to seven tools upright and out of the way with tips and sharp cutting edges safely stored.

Stock #	Size	
G. HOL-356.00	4" x 2 1/2" x 2"	\$13.95



Blades that are not being used can be stored inside the barrel.

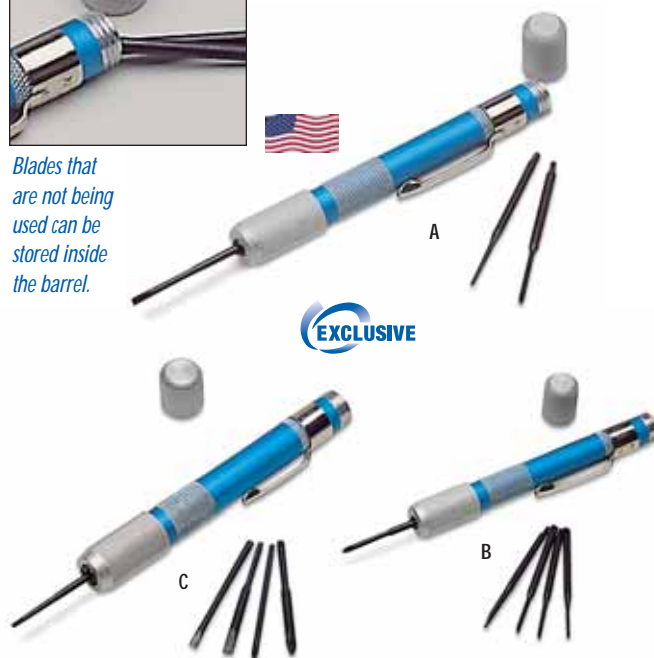

Phillips Screwdriver Set

1.20mm: Grey
1.50mm: Purple
2.00mm: Green
2.50mm: Blue





NINE PIECE ECONOMY SCREWDRIVER SET

Set contains sizes 0.80 to 2.0mm with tempered steel blades and nickel-plated handles. All have hex-shaped, non-roll heads.

Stock #	Description	
A. SCR-926.00	Set of 9	\$4.60



SET SCREW JEWELERS' SCREWDRIVER SET

Economical jewelers' screwdriver set for fine work. Includes five straight blades (1.0, 1.2, 1.4, 1.6, 2.0mm) and four Phillips (1.6, 2.0, 2.5, 3.0mm). Color-coded heads, chrome-plated steel.

Stock #	Description	
B. SCR-929.00	Set of 9	\$11.95



C. INDIVIDUAL ECONOMY SCREWDRIVERS

Economic screwdrivers available individually, which are very hard to find, are now offered by EURO TOOL. If you need several of one size rather than a set, this is the answer. We can make custom sets upon request.

Stock #	Description	Size	
SCR-901.20	Phillips Blade	1.20mm	\$0.89
SCR-901.40	Phillips Blade	1.40mm	\$0.89
SCR-901.60	Phillips Blade	1.60mm	\$0.89
SCR-902.00	Phillips Blade	2.00mm	\$0.89
SCR-911.20	Straight Blade	1.20mm	\$0.89
SCR-911.40	Straight Blade	1.40mm	\$0.89
SCR-911.60	Straight Blade	1.60mm	\$0.89



COMBO SCREWDRIVER SET

Our six piece screwdriver set includes four straight blade screwdrivers (1.0, 1.20, 1.80, 2.40mm) along with #0 and #1 Phillips screwdrivers. All have hexagonal swivel heads. Packed in a convenient hard plastic box.

Stock #	Description	
D. SCR-905.00	Set of 6	\$2.95



STRAIGHT BLADE SCREWDRIVER SET

The blades are tempered for long life, and set firmly in plated handles with swivel heads. Sizes of screwdrivers included in the set are: 1.00, 1.40, 2.00, 2.40, 3.00 and 3.50mm.

Stock #	Description	
E. SCR-910.00	Set of 6	\$2.95



NUT DRIVER SET

Five piece nut driver sets are invaluable for clock makers, camera repair and electronics. Ours feature anodized, tempered blades and nickel-plated hex heads. Each set comes with a T-bar for extra torque with the following sizes of drivers: 3.00, 3.50, 4.00, 4.50 and 5.00mm. Length 4¹/₈".

Stock #	Description	
F. SCR-912.00	Set of 5	\$2.95



MINI WRENCH SET

Five piece miniature wrench set for hard-to-reach areas. Each has an anodized tip with nickel-plated handles for years of rust-free service. Includes the following sizes: 4.00, 4.50, 5.00, 5.50 and 6.00mm. 4¹/₈" length.

Stock #	Description	
G. SCR-913.00	Set of 5	\$2.95

GERMAN SHEAR

This practical shear features PVC cushion grips and cuts up to 20 gauge sheet stock. The overall length is 7" with a 1½" straight blade. You'll get years of service and satisfaction with this very popular shear. Made in Germany.

Stock #	Total Length	Blade Length	
A. SHR-535.00	7"	1½"	\$15.60

SHEAR with SPRING

Made of stainless steel, this shear features precision blades with keen cutting edges, PVC comfort grips and return springs for comfort and speed. The pattern of this shear is identical to our German shears.

Stock #	Description	Total Length	Blade Length	
B. SHR-536.00	Shear w/ Spring	7"	1½"	\$8.65

HIGH-LEVERAGE, ALL-PURPOSE SHEAR – USA MADE

Scissor handle shears are great for cutting heavier metals and copper plate up to B & S gauge #20. Large loop handles are extra comfortable.

Stock #	Description	Total Length	Blade Length	
C. SHR-555.00	Heavy Blade	7¾"	2"	\$23.65
D. SHR-558.00	Narrow Blade	7¼"	1¾"	\$28.95

EURO SHEARS

Will cut anything from paper to heavy tin with their tempered stainless steel blades. The plastic handles provide comfort, lessen fatigue and feature a return spring. Made in Germany.

Stock #	Total Length	
E. SHR-304.00	7½"	\$16.35
SHR-305.00	5½"	\$14.45

FRENCH SHEARS

Our blue-handled French shears can cut up to 20 gauge sheet stock. With narrow points for easy maneuvering, this series features the best blades made. The overall length is 7" with a 1½" blade length. You'll get years of service and satisfaction.

Stock #	Description	
F. SHR-530.00	Straight	\$15.75
SHR-530.01	Straight with Springs	\$22.35
G. SHR-531.00	Curved	\$19.20
SHR-531.01	Curved with Springs	\$25.55

SCISSOR SHEARS

Cut tight patterns, circles and templates with our 7" long scissor shears. They're German-made of the finest European steel. The shape of the shears, the grips and 1½" blades allow for precise control.

Stock #	Description	
H. SHR-532.00	Straight	\$13.95
I. SHR-533.00	Curved	\$15.95

CROWN SCISSORS

Stainless steel crown scissiors are 4½" long and feature large looped handles for comfortable use. Excellent for cutting soft wire and very light metals.

Stock #	Description	
J. SCI-440.00	Straight Blade	\$4.20

LINDSTROM MULTIPURPOSE SHEAR

Lindstrom shear precisely cuts through 28 gauge silver stock. With ergonomic, cushion grip handles, this shear is a pleasure compared to others. The blades are 57-59 Rockwell for long life. The return spring has the right amount of tension to return the blades to the open position.

Stock #	Length	
K. SHR-600.00	5¾"	\$33.95



French Shears available in straight or curved; with or without springs.

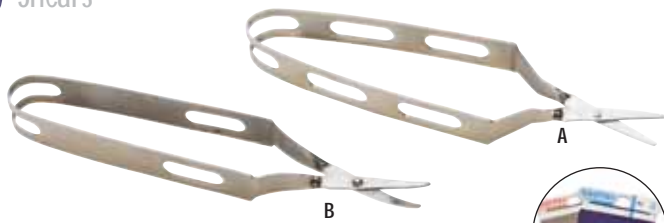

Squizzers are excellent thread scissors for use with our Griffin, Tuff Cord and Silk Alike bead cord (page 16–17).

Blades are slightly rounded for safety.

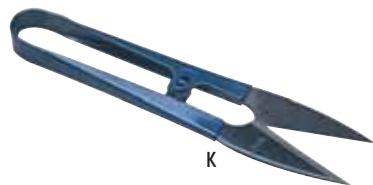

On the Cutting Edge

SQUIZZERS – THE REVOLUTIONARY NEW SCISSORS



Revolutionary new scissors have a more acute shearing angle to cut cleaner and smoother than regular scissors. Consistent cutting at the tip, one blade is lightly serrated to hold thread or cord and eliminate slippage. With surgical-grade series 300 stainless “spring steel”, Squizzers will last longer and will not rust or corrode.

Stock #	Description	Length	Blade Length	
A. SCI-520.00	Straight, Serrated	4 ³ / ₄ "	5 ¹ / ₈ "	\$12.95
B. SCI-525.00	Curved, Serrated	4 ³ / ₄ "	5 ¹ / ₈ "	\$15.95

LARGE LOOP SCISSORS

Ever try to get your fingers through most cuticle type scissors? Here's an improvement you'll appreciate – larger loops! Make cutting easier with precision and comfort. Great for bead cord and other light jobs. Made of stainless steel.

Stock #	Description	Length	
C. SCI-103.00	Straight Blade	4"	\$4.55

BIRD SCISSORS

They've been around for years, but people seem to love the stylish, impulsive look of “Bird Scissors” and they work well for bead stringing and other small projects. Stainless steel, crisp and sharp!

Stock #	Total Length	
D. SCI-104.00	4"	\$5.95



CUTICLE SCISSORS

Stainless steel cuticle scissors have very sharp 1" blades to cut thread, ribbon, etc. The fine points allow access to tight areas.

Stock #	Description	Length	
E. SCI-455.00	Straight Blade	3 ¹ / ₂ "	\$3.35
F. SCI-456.00	Curved Blade	3 ¹ / ₂ "	\$3.35
G. G.SCI-102.00	Straight Blade, Gold Handles	3 ¹ / ₂ "	\$3.50

PRECISION SCISSORS

The perfect pair of scissors for all beading and other delicate work. Large handles, made of lightweight black ABS plastic and sculpted for more comfort than traditional scissor handles. Small pointed blades are made of high-quality stainless steel held together with a high-impact rivet and nylon washer for smooth cutting and extended life.

Stock #	Length	Blade Length	
H. SCI-101.00	3 ⁵ / ₈ "	3 ¹ / ₄ "	\$9.95
I. SCI-105.00	4"	1 ¹ / ₄ "	\$9.95
J. SCI-110.00	4 ³ / ₄ "	1 ¹ / ₂ "	\$10.95

MICRO SNIP

Perfect for bead stringing and thread snipping. Well-tempered with very sharp edges. Reflex action makes light work fast and easy.

Stock #	Total Length	
K. SHR-210.00	3 ¹ / ₂ "	\$2.95

Easy Turn Knobs!



Gentec has been selling torches and welding accessories worldwide for over 40 years. Now EURO TOOL is offering the same great quality in the "Small Torch" to jewelers and craftsmen. The "Small Torch" regulators and other accessories are high quality, manufactured to world standards, and offer great value. Braze and solder material from the tiniest up to 1/8" thick steel. Easy manipulation in very tight spaces. Provides stable and precise concentrated feather flame up to 6000°F. Durable and flexible hoses ("B Connection") with "A" fittings adapter included. All components carry a limited two year warranty from the factory, further backed by EURO TOOL's reputation of guaranteeing customer satisfaction.

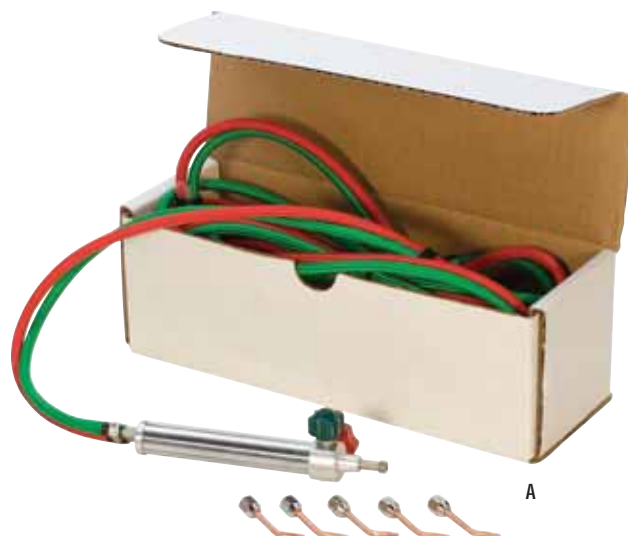

A. THE SMALL TORCH BASIC KIT with EASY TURN KNOBS

Each basic kit contains The Small Torch handle, five tips, and 12' oxygen and fuel hoses with "B" fittings (9/16") and "A" fittings (3/8") adapter.

Stock #	Description	
SOL-205.10	For Oxy/Propane (tips: #3, 4, 5, 6, 7)	\$116.80
SOL-225.10*	For Oxy/Acetylene (tips: #2, 3, 4, 5, 6)	\$116.80

*Please note: Tip #2 is for use with oxygen/acetylene only.

B. THE SMALL TORCH BASIC KIT

Each basic kit contains The Small Torch handle, five tips, and 12' oxygen and fuel hoses with "B" fittings (9/16") and "A" fittings (3/8") adapter.

Stock #	Description	
SOL-205.00	For Oxy/Propane (tips: #3, 4, 5, 6, 7)	\$116.80
SOL-225.00*	For Oxy/Acetylene (tips: #2, 3, 4, 5, 6)	\$116.80

*Please note: Tip #2 is for use with oxygen/acetylene only.

C. THE SMALL TORCH KITS with REGULATORS

Contains The Small Torch handle, five tips, 12' fuel hoses with "B" fittings (9/16"), fitting adapter "A" (3/8") and oxygen and acetylene or propane regulators. Precision-machined brass regulators feature a compact rear entry design. Chrome-plated housing caps with plastic adjustment knob for smooth "easy touch" pressure setting.

Stock #	Description	
SOL-206.00	For Oxy/Propane (tips: #3, 4, 5, 6, 7)	\$311.20
SOL-226.00*	For Oxy/Acetylene (tips: #2, 3, 4, 5, 6)	\$311.20

*Please note: Tip #2 is for use with oxygen/acetylene only.

D. PORTABLE SMALL TORCH OXY/PROPANE KIT

Convenient portable kit for use with disposable tanks comes complete with torch handle, #4 tip, 6' hoses and preset regulators for propane and oxygen. Wire tank holder included.

Stock #	Description	
SOL-208.00	For Oxy/Propane Disposable Tanks	\$161.65

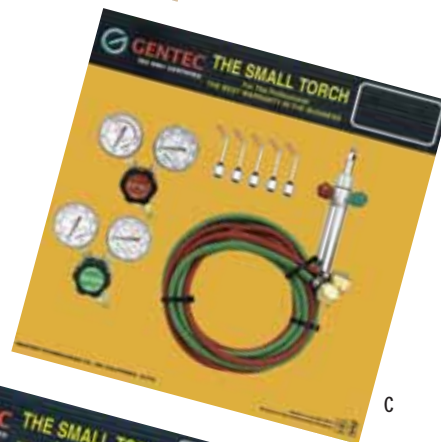



Rear entry design of the regulators mean they stay completely in the tote.



A



B

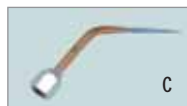

C



D



recessed-end
propane tip



flush-end
acetylene tip



E



F



G



H



I



J



K



L



M

COMPLETE SMALL TORCH CADDY KIT

Deluxe set includes torch handle, hoses, five tips, regulators, and tanks all with a handy plastic carrying caddy. Oxy/Acetylene Kit comes with oxygen and acetylene tanks. Oxy/Propane Kit for use with disposable tanks; comes with oxygen tank only. Tanks shipped empty. All caddy kits come with check valves.

Stock #	Description	Wt.	
A. SOL-207.00	Oxy/Propane Kit with Caddy (tips: #3, 4, 5, 6, 7)	25 lbs.	\$370.15
B. SOL-227.00*	Oxy/Acetylene Kit with Caddy (tips: #2, 3, 4, 5, 6)	33 lbs.	\$496.85

*Please note: Tip #2 is for use with oxygen/acetylene only.

SMALL TORCH TIPS

Extra tips to fit Oxy/Fuel Small Torch for high temperature melting and soldering applications.

Stock #	Description	
C. SOL-200.02*	Tip #2	\$18.10
SOL-200.03	Tip #3	\$18.10
SOL-200.04	Tip #4	\$18.10
SOL-200.05	Tip #5	\$18.10
SOL-200.06	Tip #6	\$18.10
SOL-200.07	Tip #7	\$18.10
D. SOL-200.23	Twin Tip (Two #3 tips)	\$27.60

*Please note: Tip #2 is for use with oxygen/acetylene only.

SMALL TORCH MELTING TIPS

Specially designed multiple-orifice tip for maximum melting power of up to 3 ounces of gold, silver or bronze. Multiple-orifice end produces flames which converge to produce a single flame.

Stock #	Description	Tip	
E. SOL-204.60	6" Propane Melting Tip	Recessed	\$25.15
F. SOL-224.60	6" Acetylene Melting Tip	Flush	\$25.15

SMALL TORCH REGULATORS

Gentec regulators are manufactured using the latest state-of-the-art equipment. With chrome plated housing caps and body machined from class "A" brass bar stock, our regulators are single stage with rear entry construction. This compact rear mounted design allows the regulators to better fit in caddy systems and keep safely out of the way. Internal safety pressure relief valve and stem type seat assembly for more reliable seating.

Stock #	Description	
G. SOL-200.25	Oxygen Regulator	\$76.45
H. SOL-204.25	Propane Regulator	\$71.30
I. SOL-224.25	Acetylene Regulator (MC Tank)	\$71.30
SOL-224.26	Acetylene Regulator ("B" Tank)	\$71.30
J. SOL-208.01	Oxygen Regulator for Disposable Tanks	\$37.50
K. SOL-208.02	Fuel Regulator for Disposable Tanks	\$37.50

L. SMALL TORCH REPLACEMENT HOSES

Durable and flexible hoses for The Small Torch come standard with "B" fitting and include an "A" fitting adapter with each. Replacement hose clamps also available.

Stock #	Description	Length	
SOL-200.40	Repl. Small Torch Hose Set - 2 pc	6'	\$35.00
SOL-200.50	Repl. Small Torch Hose Set - 2 pc	12'	\$48.60
SOL-200.41	Hose Crimps		\$2.10



All Gentec products
are UL Approved.

TORCH HOSE CRIMPER

Crimping tool allows you to easily and securely crimp new hoses to your torch.

Stock #	
M. PLR-798.20	\$19.95

SWIRL FLAME TIPS

Air acetylene swirl flame tips produce a very hot efficient flame for fast soldering, brazing, and melting. A helical blade, inside the stainless steel replaceable tip end, premixes the fuel gas and air to achieve maximum combustion efficiency. All tips have quick connect ends for easy tip changes. Use with our SOL-250.10 handle for an efficient casting torch.

Stock #	Description	
A. SOL-270.02	Air/Acetylene Swirl Flame Tip #2	\$43.10
SOL-270.03	Air/Acetylene Swirl Flame Tip #3	\$49.15
SOL-270.05	Air/Acetylene Swirl Flame Tip #5	\$55.00
SOL-270.08	Air/Acetylene Swirl Flame Tip #8	\$59.35
SOL-270.11	Air/Acetylene Swirl Flame Tip #11	\$68.80
SOL-270.14	Air/Acetylene Swirl Flame Tip #14	\$76.95
B. SOL-270.50	Quick Connect Adaptor	\$24.20

CASTING TORCH

The GENTEC casting torch handle and components are machined with highest quality materials and the handle features a "Tube-in-a-Tube" design for high handle strength. Combine with heating tips for a customized versatile casting, soldering and melting torch ideal for gold, silver and platinum.

Stock #	Description	
C. SOL-250.10	Torch Handle	\$90.10
D. SOL-250.15	Propane Tube Tip with #6 Tip	\$40.20
SOL-260.66	Acetylene Tube Tip with #6 Tip	\$42.20
E. SOL-260.20	Acetylene Rosebud Nozzle	\$28.15
F. SOL-250.50	12' Dual Hose w/ A-B Connectors	\$24.30
G. SOL-250.18	Tip Tube (for propane and acetylene tips)	\$29.10
H. SOL-250.01	Propane Tip #1	\$13.60
I. SOL-250.02	Propane Tip #2	\$13.60
J. SOL-250.03	Propane Tip #3	\$13.60
K. SOL-250.04	Propane Tip #4	\$13.60
L. SOL-250.05	Propane Tip #5	\$16.15
M. SOL-250.16	Acetylene Rosebud Tip	\$20.35
N. SOL-260.01	Acetylene Tip #1	\$11.00
O. SOL-260.02	Acetylene Tip #2	\$11.00
P. SOL-260.03	Acetylene Tip #3	\$11.00
Q. SOL-260.04	Acetylene Tip #4	\$13.75
R. SOL-260.05	Acetylene Tip #5	\$13.75
S. SOL-260.06	Acetylene Tip #6	\$15.50

REGULATORS

GENTEC compressed gas regulators are machined from class "A" brass bar stock using state-of-the-art equipment. They are produced, assembled and tested by an experienced, proud and dedicated work force that is committed to its highest standards of product integrity. Gentec quality regulators provide superior performance and safety features with an emphasis on value. Single stage regulators have internal safety pressure relief valves and are lightweight and compact ideal for most applications. Dual stage regulators provide more precise control and constant delivery over a wide range of inlet pressures. They come with self re-seating external safety pressure relief valve. All have standard 9/16" B fittings. UL approved.

Stock #	Description	
T. SOL-210.25	Single Stage Oxygen Regulator	\$88.35
U. SOL-212.25	Dual Stage Oxygen Regulator	\$239.15
SOL-210.20	Single Stage Propane/MAPP Regulator	\$88.35
SOL-212.20	Dual Stage Propane/MAPP Regulator	\$239.15
SOL-210.30	Single Stage Acetylene Regulator	\$88.35
SOL-212.30	Dual Stage Acetylene Regulator	\$239.15
SOL-210.50	Single Stage Hydrogen Regulator	\$234.00



V. TORCH WRENCH

Multi-purpose wrench for fittings on hose, tank, torch and regulator connections.

Stock #	
SOL-289.00	\$9.35



Swirl flame tips great for fast soldering, brazing and melting.



Use the Tip Tube (SOL-250.18) with Propane or Acetylene Tips.

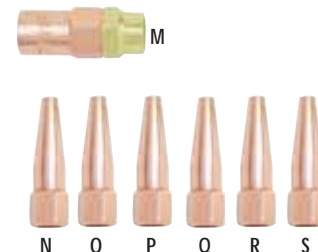

Dual stage or single stage regulators available for Oxygen or Fuel.



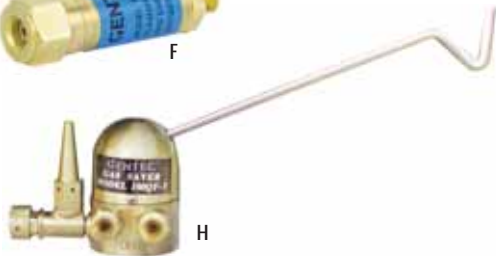
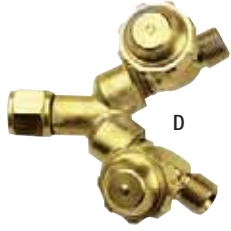
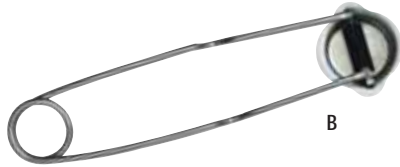

TORCHMATE

Automatic torch lighter allows you to light any torch using only one hand. Comes complete with 2 AA batteries.

Stock #	Description	Price
A. SOL-292.00	Torch Lighter	\$25.95

TORCH LIGHTER

Traditional spark lighter supplied with flints. Extra flints available.

Stock #	Description	Price
B. SOL-290.00	Torch Lighter	\$1.71
SOL-290.01	Flints, pk/5	\$1.60

"Y" CONNECTORS

GENTEC "Y" connectors are high quality brass, with on-off valves and standard "B" (9/16") connections. Allows multiple torch use from a single tank and regulator. Must order specifically for fuel line or oxygen line.

Stock #	Description	Price
C. SOL-200.55	"Y" Connector for Fuel	\$32.75
D. SOL-200.60	"Y" Connector for Oxygen	\$32.75

FLASHBACK ARRESTORS

Flashback Arrestors are specially designed to prevent personal injury and damage to equipment from flashbacks. With built in check valves, they stop the reverse flow of gas as well as extinguishing the flashback flame.

Stock #	Description	Price
E. SOL-280.50	Flashback Arrestors- pair, for torch to hose	\$45.05
F. SOL-280.52	Flashback Arrestors- pair, for regulator to hose	\$45.05

CHECK VALVES

Check Valves prevent reverse flow of gases which can cause dangerous mixtures. Use of check valves between the torch and the regulator at all times is strongly recommended. They are easily attached to any regulator outlets with standard 9/16" connections. Sold in pairs- one for fuel regulator, one for oxygen regulator.

Stock #	Description	Price
G. SOL-282.50	Check Valves- pair	\$14.65

H. GENTEC GAS SAVERS

Double shut-off valves with pilot flame are designed for quick shut-off and easy restart of the working flame during torch operations. The working flame is automatically extinguished and the gas flow discontinued by placing the torch handle on the convenient hook. To re-ignite the working flame, lift the torch handle from the hook and place the tip close to the pilot flame. Our dual shut-off valve assembly is convenient, safe and fuel-efficient. **Gas savers not for use with Small Torches.** Maximum pressure: oxygen 150 PSI; fuel gas 22 PSI.

Stock #	Description	Price
SOL-204.30	For Oxy/Propane	\$60.10
SOL-224.30	For Oxy/Acetylene	\$59.50



I. SOLDERING KIT

Our nine piece Soldering Kit includes all the essential tools for basic soldering applications. Includes: Max Flame Torch, Sparex, Silver Solder, Flux, Magnesia Block, Copper Tongs, #1 Style Tweezer, Fiber Grip Tweezer and Tripod with Mesh Screen.

Stock #	Description	Price
KIT-200.09	Basic Soldering Kit	\$79.95
KIT-200.10	Basic Soldering Kit w/ Pickle Pot	\$99.95



Add a pickle pot to the Basic Soldering Kit – page 202.

JEWELER'S TORCH ADAPTER SET

Set includes six micro-tips and a connector. The non-oxidizing flame saves valuable production time because less time is needed in the pickle pot. For use with natural gas, artificial gas, propane or butane torches. Wrench included for easy removal of tips. Not recommended for use with acetylene.

Stock #		
A. SOL-260.00		\$19.95



TORCH HOLDER

From EURO TOOL, a torch holder at a very affordable price. Holds your torch at the perfect angle, making it handy and safe to use. Also keeps tips conveniently organized. Made with a sturdy cast base and heavy duty (4mm) rod, this torch holder is virtually indestructible.

Stock #		
B. HOL-154.00		\$11.95



TORCH HOLDER with CLAMP

Our unique torch holder features a two-way clamp and may be attached to bench top edge or the lip of a bench to hold various torches within easy reach. Clamp allows easy mobility so it can be put wherever most handy. All stainless steel.

Stock #	Length	
C. HOL-635.00	6 1/2"	\$9.95



EXCLUSIVE



TORCH HOOK

Sturdy torch hook, 11" long, screws to bench top for a convenient, safe place to hang your torch when not in use.

Stock #		
D. HOL-630.00		\$1.85

E. SOLDERING GLASSES

We now have available #5, #7 and #10 green lens glasses for soldering platinum. The #7 is the lens approved by the Platinum Guild, but some users prefer a slightly lighter #5 green. The #10 lens is used when casting. Glasses are black, lightweight plastic – very comfortable with adjustable earpieces and replaceable polycarbonate lenses. CE approved. You can't get better. Made in Germany.

Stock #	Description	
GLS-100.05	Welding Goggles #5	\$15.40
GLS-100.07	Welding Goggles #7	\$15.70
GLS-100.10	Welding Goggles #10	\$15.70
GLS-100.15	#5 Lens for GLS-100.05	\$3.60
GLS-100.17	#7 Lens for GLS-100.07	\$4.15
GLS-100.20	#10 Lens for GLS-100.10	\$4.15



SAFETY GLASSES

All clear safety glasses with five point adjustable earpieces. Lenses can be adjusted horizontally to the angle you prefer. They are wrap-around and made of high-impact plastic. The lenses are distortion-free and scratch resistant. Made in Germany.

Stock #		
F. GLS-120.30		\$16.75



SAFETY GLASSES

Wrap-around safety glasses are easily removable but protect eyes with comfort. Lenses are extra clear high impact material. Earpieces are four point adjustable. Distortion-free lenses and wrap-around design assures particles can't reach the users' eyes when worn properly. Glasses feature holes for elastic strap or chain. Made in Germany.

Stock #		
G. GLS-120.24		\$10.10





A
Stands upright in
secure metal base.



CAUTION:
Always wear
proper eye
and face
protection.



MICRO-FLAME BUTANE TORCH

Our top-quality Micro-Flame butane torch is six inches tall, features electronic ignition (no lighter necessary), a maximum temperature of 2450 °F and a 90 minute burn. Easy-adjust feature assures the right flame for any job with precision accuracy.

Stock #	Description	
A. SOL-300.00	Micro-Flame Butane Torch	\$36.95

MAX FLAME BUTANE TORCHES

Our Max Flame butane torches feature a large flame nozzle which is desirable for many applications. Features include adjustable flame, quick refill design, safety lock, ergo design, electronic ignition and a maximum temperature of 2450 °F. Our 7¹/₄" tall jumbo model offers the same features but with a larger capacity giving a longer burn time.

Stock #	Description	
B. SOL-302.00	Max Flame Butane Torch	\$36.95
C. SOL-310.00	Jumbo Max Flame Butane Torch	\$39.95

MICRO-THERM TORCH

Our Micro-Therm torch, which works from a normal lighter refill, offers a heat source which tops out at 750 °F without an exposed flame. Eliminate flares, smooth out rough edges or parting lines from wax castings. Comfortable palm grip with locking trigger and auto shut-off.

Stock #		
D. SOL-320.00		\$36.95

MICRO FLAME BURNER

Self-igniting Micro Flame Burner is fueled by butane and gives a pure hot flame without smoke. The housing has a broad base making this burner virtually impossible to tip over. Reach the temperature you need faster with this efficient unit.

Stock #		
E. LMP-424.00		\$32.95

ALCOHOL LAMPS

Made of the best materials available, our glass alcohol lamps have facets for inclining, if desired. The top is a quality nickel-plated brass with an adjustable wick. Use denatured alcohol as a fuel. Excellent for heating wax tools.

Stock #	Description	
F. LMP-423.00	Lamp with 1/2" Wick	\$7.05
LMP-423.10	Replacement Wick 1/2"	\$0.79
G. LMP-422.00	Lamp with 3/16" Wick and Adjustment Knob	\$6.95
LMP-422.10	Replacement Wick 3/16"	\$0.45

TRIPOD with MESH SCREEN

Tripod with mesh screen used to stand over an alcohol lamp or Bunsen burner to keep wax pot warm.

Stock #	Description	
H. SOL-730.00	9" Tripod w/Mesh Screen	\$9.65
I. SOL-735.00	6" Tripod w/Mesh Screen	\$8.95
SOL-730.10	Replacement 6" x 6" Mesh Screen	\$2.85

LITTLE DIPPER PICKLE POT

You can pay a lot more and never come close to the quality of this pickle pot. It is made by Rival®, stainless steel, with a stoneware bowl. Sure they call it a crock-pot, but it's the best and most economical pickle pot available. Capacity is 16 oz. with a shipping weight of 2.6 lbs.

Stock #		
J. CLN-584.00		\$23.95

SPAREX PICKLING COMPOUND

Sparex is an easy to use, longer lasting, safe replacement for dangerous sulfuric acid in effective cleaning and pickling metals. Use Sparex No. 2 for removing surface oxidation, scale and pickling gold, silver and copper based alloys. Non-flammable and non-explosive.

Stock #	Description	
K. SOL-802.10	Sparex No. 2 - 10 oz. Can	\$3.50
L. SOL-802.40	Sparex No. 2 - 2 1/2 lb. Bag	\$7.50

HEETRIX™

Another jeweler's bench space saver by EURO TOOL. The Heetrix, designed by a jeweler, mounts on top of the bench and the soldering platform swings out of the way when not in use. It also rotates for convenience. The included special third hand attachment with a fibre grip tweezer easily allows for hands free work. Remove the fitted Solderite Disc and a depression is revealed which holds soldering grain. Great for holding small parts and may be used wet or dry. Replaceable Solderite disc is 3³/₄" and overall length with swing arm is 7". Weight 1.8 lbs.

Stock #	Description	
A. SOL-510.00	Heetrix	\$44.95
SOL-414.00	Replacement Solderite Disc	\$6.65
TWZ-740.04	Replacement Fiberglass Tweezer	\$2.10

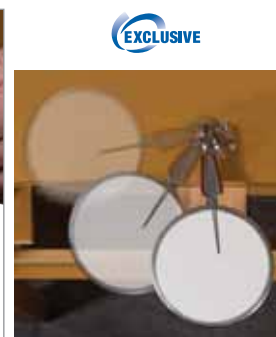

Soldering platform swings out of the way when not in use.

COOL CUP

This EURO TOOL exclusive is a jeweler's dream for soldering rings when re-sizing. Just fill the cup with cold water and submerge the stone and mounting while soldering the shank to keep the stone cool. Simple, but effective. Soldering cup includes special sized negative locking tweezer designed to slip on and off the post. This is a tool for virtually every jeweler.

Stock #	Description	
B. SOL-700.00		\$12.95

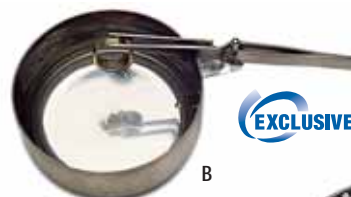
**ANNEALING PAN**

Annealing pan rotates 360° on ball bearings for unlimited access to work. Heat reflecting pumice for uniform heat when annealing or soldering. Pan is 7" (305mm) in diameter and comes with 1.5 lbs. of pumice.

Stock #	Description	
C. SOL-520.00	Annealing Pan with Pumice	\$29.95
SOL-522.00	Replacement Pumice - 1.5 lbs.	\$14.95

**THIRD HANDS**

Handy work holders feature a tweezer or clips mounted on a weighted base to hold items stable and secure in any position while soldering. Enables user to have both hands free while working. Offered in several styles including: single third hands with 6¹/₂" or 4¹/₂" tweezers or secure alligator clips on double third hands with or without magnifier.

Stock #	Description	
D. HOL-162.00	Double Third Hand with Clips	\$11.45
E. HOL-163.00	Double Third Hand with Clips and Magnifier	\$5.95
F. HOL-164.00	Single Third Hand with 4 ¹ / ₂ " Tweezer	\$5.95
G. HOL-165.00	Single Third Hand with 6 ¹ / ₂ " Pointed Tweezer	\$87.95
HOL-165.50	Single Third Hand with 6 ¹ / ₂ " Blunt Tweezer	\$7.95
HOL-162.01	Clips (pair)	\$3.75
HOL-165.01	Third Hand Base Only	\$7.45



Hands free helpers!

RING HOLDER

A heavy cast iron base keeps holder and ring from moving during soldering. Prongs are adjustable for different size rings. Base diameter 3" and total height 2".

Stock #	Description	
H. HOL-164.50		\$4.95

**CERAMIC RING STAND**

Very handy for all types of assembly and repair. With a heavy metal base and heat-reflective ceramic rod, the swivel action easily allows for exact position or angle desired. Extra ceramic mandrels allow for work on several projects at a time.

Stock #	Description	
I. HOL-155.00	Ring Stand with Ceramic Mandrel	\$15.75
HOL-155.10	Replacement 6" Ceramic Mandrel	\$9.25



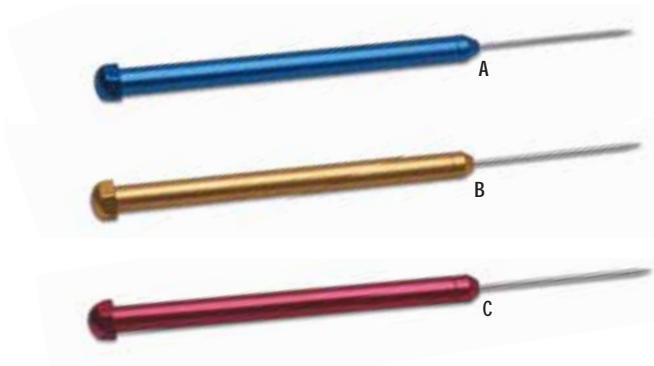

*No. 35 high-tech titanium rod
means solder won't stick!*



*To prepare the Burn Away Flux Brush for
first use, simply sharpen as you would a
pencil until the bristles are exposed.*



DELUXE TITANIUM SOLDERING PICKS

EURO TOOL's popular blue handled soldering pick is now available in gold and red as well. This style, with a non-roll handle, features a titanium shaft, which is the absolute best for all non-ferrous metal except platinum. Three colors keep you from cross contaminating. 6 1/2" length.

Stock #	Description	
A. SPK-930.00	Blue	\$4.55
B. SPK-930.00G	Gold	\$4.55
C. SPK-930.00R	Red	\$4.55
SPK-930.99	3 pc Set (1 each blue, gold, red)	\$13.65

NIOBIUM PICK for PLATINUM

Niobium is a little known metal with a sky high temperature tolerance of 4,470° F. It is excellent for platinum and the only metal where contamination is virtually impossible. Niobium may be bent to the desired angle without breaking. 6 3/4" length.

Stock #		
D. SPK-945.00		\$6.45

TUNGSTEN PICK for PLATINUM

Our tungsten soldering pick can withstand higher temperatures than titanium picks. Will not contaminate platinum. 6" length.

Stock #		
E. SPK-940.00		\$6.95

SOLDERING PICK

This pick has a total length of 6 1/4" and is made with a special alloy. The point can be bent to any shape without breaking. It has a hardwood handle for insulation.

Stock #		
F. SPK-925.00		\$2.45



BURN AWAY FLUX BRUSH

Burn Away Brushes are perfect for applying flux while soldering because the bristles of the brush are fire resistant. They can also be used by jewelers or hobbyists to apply paint, lacquer or other

materials, as bristles are fine and soft. Priced per each and sold in packs of six.

Stock #	Description	
G. BRS-710.00	Small Flux Brush	\$3.95
H. BRS-715.00	Large Flux Brush	\$4.25



UTILITY/FLUXBRUSH

Natural bristle acid brushes have crimped all-metal handles. Economical, general purpose utility brush great for one-time use applications to save time and avoid messy cleanups. Suitable for acid, flux, epoxy, glue, paste, touch-ups, solvents and more. Sold in packs of twelve.

Stock #	Size	Qty.	
I. BRS-980.05	3/8" x 6"	pk/12	\$1.85

FLUX BOTTLE with STAINLESS STEEL SPOUT

This is a hot and handy item for depositing flux or any other liquid exactly where you want it with just an easy squeeze. The bottle has a two ounce capacity.

Stock #		
J. SOL-901.00		\$4.45

A. AQUIFLUX

It's the tried-and-true jewelers' hard soldering flux. Yellow-green and self-pickling, it is the best in water-based fluxes. Well-mixed to eliminate suspension.

Stock #	Description	
SOL-932.03	Half Pint (12 per case)	\$4.45
SOL-932.10	Quart (12 per case)	\$10.95
SOL-932.15	Gallon (4 per case)	\$24.95



B. HANDY FLUX

Handy Flux is a very durable and powerful general purpose flux that protects your parts up to 1600°F (870°C). It is an active fluoride-type flux which is appropriate for all nonferrous metals and begins to melt and dissolve oxides at 600°F (320°C). Paste formula can be cleaned up with hot water.

Stock #	Description	
SOL-950.01	7 oz. Jar with Brush	\$5.95
SOL-950.03	1/2 lb. Jar	\$6.50
SOL-950.04	1 lb. Jar	\$10.95



KWIKFLUX

A quick and clean, creamy paste flux for silver brazing and hard soldering. Use with all jewelers' metals including silver, gold, copper, nickel and platinum.

Stock #	Description	
C. SOL-935.03	12 oz.	\$9.95

MAGIC FLAME

Magic Flame is a long-lasting 4-in-1 soldering compound. It eliminates fire scale, is biodegradable and non-flammable, so there is no surcharge to ship it via UPS.

Stock #	Description	
D. SOL-935.10	8 oz. (12 per case)	\$10.45

MAGIC BORIC

Requires only that you dip the piece into Magic Boric and solder – the flux is built right in. No burn-off or waiting to solder. It prevents fire scale and will cut your soldering time by as much as 50%. Non-flammable and non-hazardous to ship.

Stock #	Description	
E. CLN-190.00	16 oz. (12 per case)	\$9.95

COOL GUARD

Designed to provide a protective heat barrier and to retard the transfer of heat through metal during welding and soldering applications. Can be applied to stones to protect from heat related damage. It will adhere to most surfaces.

Stock #	Description	
F. SOL-970.10	1 lb. Jar	\$14.95

FIRESCOFF®

Firescoff Rh is an improved spray ceramic coating that replaces both your firecoat and flux. Firescoff Rh now adds greater protection for rhodium and gold filled metals, allowing soldering without damage to the plated layer. In addition, Firescoff Rh protects rhodium from turning black. Benefits include:

- Superior fire scale protection for silver, gold, palladium, copper, brass, bronze, titanium, stainless steel, rhodium and gold filled metals.
- Protects gemstones from heat oxidation.
- Acts as a flux, no additional flux is needed or required.
- Affordable technology that saves significant time and labor.
- Longer working time at higher temperature.
- Easy water cleanup that eliminates the need for an acid pickle pot solution.

Available in 125 ml bottle or a 2 ml sample which is enough to coat and protect up to three rings.

Stock #	Description	
G. SOL-980.02	Firescoff Rh – Ceramic Spray 2ml sample size	\$2.25
H. SOL-980.05	Firescoff Rh – Ceramic Spray 125ml	\$32.95

Magic Flame can be used in the following ways:

1. **Dip** – Add Magic Flame to denatured alcohol as you normally do with boric acid. This makes a super fire coat, better than boric. Add as much as you need to get the fire coat you desire.
2. **Liquid** – Add Magic Flame to a small amount of water and you have a gold and silver flux! Add the desired amount to get the flux ability you need.
3. **Paste** – Use Magic Flame at full strength and it's a superior paste flux.
4. **Casting** – Use Magic Flame at full strength and it's a superior casting flux.



D



E



F



G



H

2 ml sample is enough to coat and protect up to 3 rings!

Ultra 

Use our Ultra Polish Pads when highlighting with Liver of Sulfur – page 174.



LIVER OF SULFUR

Liver of sulfur is traditionally one of the best oxidizers for silver and other metals. It produces a durable black finish. Simply dissolve in hot water. 4 oz jar comes in lump form.

Stock #	Description	
I. SOL-600.04	4 oz.	\$11.70



New!



B

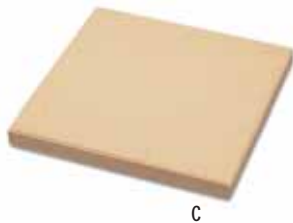

C



D



E



F

G



H

New!



I

Lightweight – only 3½ ounces!

A. TRANSITE SOLDERING BOARDS

Transite is a non-asbestos, heat reflective material. These hard Transite boards are extremely durable and withstand temperatures up to 2800 °F.

Stock #	Size	
SOL-440.10	6" x 6"	\$12.95
SOL-440.20	6" x 12"	\$18.95
SOL-440.30	12" x 12"	\$32.95

B. SOLDER-ITE™ SOLDERING BOARDS

Non-asbestos soldering pads which are durable, smooth, and heat-reflective. Fairly hard so as not to flake or crumble. Highly flame-resistant and non-combustible, these long-lasting, all-purpose pads can be used to protect surfaces from burning. Three sizes available in both hard and soft. Softer boards allow pins to be inserted to secure your work. Meets OSHA standards. Maximum temperature 1700 °F.

Stock #	Size	Description	
SOL-420.10	6" x 6" x 1/2"	Hard	\$8.95
SOL-420.20	6" x 12" x 1/2"	Hard	\$12.95
SOL-420.30	12" x 12" x 1/2"	Hard	\$22.95
SOL-421.10	6" x 6" x 3/4"	Soft	\$8.95
SOL-421.20	6" x 12" x 3/4"	Soft	\$12.95
SOL-421.30	12" x 12" x 3/4"	Soft	\$22.95

C. SOLDERING BOARDS

New Silquar material is used in our non-asbestos boards. Silquar retains heat during soldering and can be easily cleaned with water. Takes heat up to 2200 °F. Available in three sizes.

Stock #	Size	
SOL-400.10	6" x 6"	\$13.55
SOL-400.20	12" x 6"	\$18.95
SOL-400.30	12" x 12"	\$23.55

D. HONEYCOMB SOLDERING BOARDS

Popular honeycomb design holds pins to keep work in place while soldering. Made of a non-asbestos ceramic, the board is very lightweight and reflects heat. Available in two sizes. Up to 2000 °F.

Stock #	Size	
SOL-430.00	3 7/8" x 5 5/16"	\$8.50
SOL-450.00	5 1/2" x 7 3/16"	\$15.95

HI-TEMP SOLDERING BOARD for PLATINUM

This non-asbestos soldering board measures 4 1/4" x 4 1/4" x 1/2" and takes heat up to 3200 °F. Especially handy for working with platinum.

Stock #	
E. SOL-410.05	\$25.25

CERAMIC SOLDERING BOARDS

Ceramic soldering boards withstand temperature up to 2000 °F. Available flat or with feet to keep board raised slightly above the bench.

Stock #	Size	
F. SOL-465.10	6" x 6" x 1/2"	\$15.35
G. SOL-465.20	6" x 12" x 1/2" with Feet	\$17.95

MAGNESIA SOLDERING BLOCK

Non-asbestos fireproof material is fibrous so it is soft enough that one can pin objects on the surface for perfect soldering. Good for filigree work as surface stays smooth. Lightweight 3.7oz., yet durable so it's easy to ship. Withstands temperatures up to 2000 °F.

Stock #	Size	
H. SOL-455.00	6" x 3" x 2"	\$6.55

CHARCOAL BLOCK

The world's best charcoal, made of hardwood with great life and durability. This is not a soft charcoal so it will last three to five times as long. It also has better heat retention, giving the user the desired reflective heat to solder faster and easier with better flow. Our premium blocks are wrapped in PVC, then individually boxed, eliminating the mess often associated with charcoal. Great for platinum.

Stock #	Size	
I. SOL-480.00	5 1/2" x 2 3/4" x 1 1/4"	\$15.95



Silver sheet solder
now available.

SILVER BEARING SOLDER

A low-temperature, silver bearing solder paste which will speed up soldering tasks because it works with the heat of a match or lighter. Will join 22 different combinations of metals. Easy-to-use, no-mess, no-waste syringe. Capacity 7.1 grams.

Stock #		
A. SOL-820.07		\$4.75

ALUMINUM SOLDER

A great new method for soldering aluminum, this paste melts at only 395°F., far below the melting point of aluminum or any other metal. Capacity 7.1 grams.

Stock #		
B. SOL-820.21		\$5.45

Use solder cutting pliers (pg. 157) to quickly cut sheet solder into convenient 1/16" square chips.

PEWTER SOLDER

Allows user to solder and repair. Corrosion resistant, with excellent color matching abilities, it is stronger than pot metal. Great for pewter objects. Melts at 400° F. for easy workability. Capacity 7.1 grams.

Stock #		
C. SOL-820.28		\$5.45

COPPER BEARING SOLDER

No additional flux is required with this specially formulated paste for use with copper, brass, nickel or bronze. Contains no cadmium or antimony. Flows smoothly at only 430° F. Capacity 14.7 grams.

Stock #		
D. SOL-820.41		\$6.15

E. SOLDER PASTES

Solder pastes allow for precise application when used in soldering rope chain, hollow shells, findings, earring posts and other intricate jewelry designs. Convenient 10cc dispensing syringes contain a blend of solder powder, flux and binder. Exact amount required can be used eliminating waste and improving the appearance of the joint area. Silver solders are cadmium free. Gold solders are plumb.

Stock #	Description	Qty	Flow Point		Melting Point	
			°F (°C)	°F (°C)		
SOL-825.10	Silver Solder Paste 65 – Soft	1/2 oz.	1325 (718)	1240 (671)		\$20.55
SOL-825.15	Silver Solder Paste 70 – Medium	1/2 oz.	1360 (738)	1275 (690)		\$21.40
SOL-825.20	Silver Solder Paste 75 – Hard	1/2 oz.	1450 (788)	1365 (740)		\$22.35
SOL-826.40	Yellow Plumb Gold Solder Paste – 14K Soft	1 DWT	1275 (691)	1185 (640)		\$49.95
SOL-827.40	White Plumb Gold Solder Paste – 14K Soft	1 DWT	1375 (746)	1300 (705)		\$49.95

F. GOLD SOLDER – CHIPS

Our yellow gold plumb solder is convenient and ready to use in 1mm x 1mm flat pieces. Packaged one DWT per vial. Matches karat color exactly.

Stock #	Description	Quantity	Flow Point		Melting Point	
			°F (°C)	°F (°C)		
SOL-835.40	Yellow 14K Soft	1 DWT chips, 1 x 1mm	1275 (690)	1185 (640)		\$71.00
SOL-835.45	Yellow 14K Hard	1 DWT chips, 1 x 1mm	1450 (788)	1300 (705)		\$71.00
SOL-835.12	Yellow 10K Hard	1 DWT chips, 1 x 1mm	1425 (774)	1120 (605)		\$51.00

G. WIRE SOLDER

Silver soldering wire in one ounce coils. Available in soft, medium or hard. Gold wire solder sold in one DWT coil for 10K yellow gold.

Stock #	Description	Weight		Flow Point		Melting Point	
		20 ga. wire	1oz.	°F (°C)	°F (°C)		
SOL-845.10	Silver Solder Wire 65 – Soft	20 ga. wire	1oz.	1325 (718)	1240 (671)		\$29.30
SOL-845.15	Silver Solder Wire 70 – Medium	20 ga. wire	– 1oz.	1360 (738)	1275 (690)		\$31.95
SOL-845.20	Silver Solder Wire 75 – Hard	20 ga. wire	– 1oz.	1450 (788)	1365 (740)		\$32.95
SOL-846.10	10K Yellow Gold Wire Solder – Soft	24 ga. wire	– 1 DWT	1295 (702)	1190 (643)		\$34.95

H. SHEET SOLDER

Convenient sheet solder in yellow, white gold or silver. Color variations within the gold solder in order to match the karat being soldered. Recommended karat for use listed below. Sold in one DWT sheet. Silver solders sold in five DWT sheets.

Stock #	Description	Quantity	Flow Point		Melting Point	
			°F (°C)	°F (°C)		
SOL-850.10	Yellow for 10K – Soft	1 DWT	1300 (705)	1110 (599)		\$24.95
SOL-850.40	Yellow for 14K – Soft	1 DWT	1295 (702)	1190 (643)		\$39.95
SOL-850.41	Yellow for 14K – Medium	1 DWT	1350 (732)	1220 (660)		\$39.95
SOL-850.42	Yellow for 14K – Hard	1 DWT	1425 (774)	1120 (605)		\$39.95
SOL-850.80	Yellow for 18K – Soft	1 DWT	1275 (690)	1185 (640)		\$42.95
SOL-850.81	Yellow for 18K – Medium	1 DWT	1400 (760)	1275 (690)		\$42.95
SOL-850.82	Yellow for 18K – Hard	1 DWT	1450 (788)	1300 (705)		\$42.95
SOL-855.40	White for 14K – Soft	1 DWT	1275 (691)	1270 (688)		\$42.95
SOL-855.41	White for 14K – Medium	1 DWT	1325 (718)	1275 (670)		\$42.95
SOL-855.42	White for 14K – Hard	1 DWT	1350 (732)	1295 (702)		\$42.95
SOL-855.80	White for 18K – Soft	1 DWT	1295 (702)	1290 (699)		\$42.95
SOL-855.81	White for 18K – Medium	1 DWT	1425 (774)	1325 (718)		\$42.95
SOL-855.82	White for 18K – Hard	1 DWT	1445 (785)	1335 (724)		\$42.95
SOL-858.05	Silver – Extra Soft (56)	5 DWT	1205 (652)	1145 (618)		\$10.85
SOL-858.10	Silver – Soft (65)	5 DWT	1325 (718)	1240 (671)		\$8.75
SOL-858.15	Silver – Medium (70)	5 DWT	1360 (738)	1275 (690)		\$7.80
SOL-858.20	Silver – Hard (75)	5 DWT	1450 (788)	1365 (740)		\$6.30

Due to the changes in market prices,
solder pricing is subject to change.

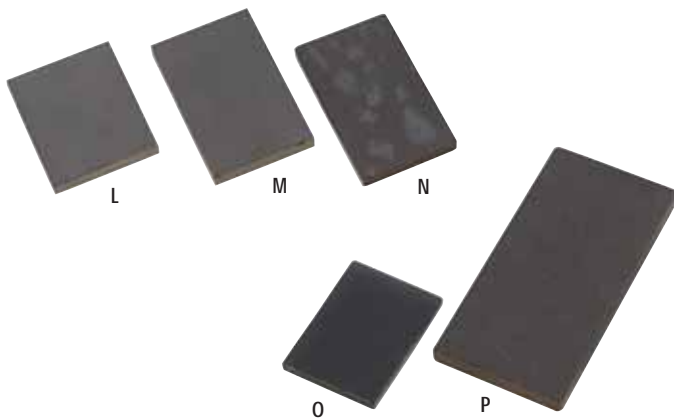

GOLD TEST KIT with GLASS BOTTLES

Set includes three glass bottles, testing stone, test needles for 10, 14, and 18K gold. Glass bottles hold 1/2 ounce of your test acids with an applicator end ground into the stopper.

Stock #	Description	
A. TES-810.00	Gold Test Kit w/ Glass Bottles	\$41.95

GOLD TEST KIT

Packaged in a beautiful and functional wooden box, the gold test kit features three test needles (10K, 14K and 18K), testing acids (10K, 14K and 18K) and a touch-stone. * Gold Test Kit ships via ground transportation only.

Stock #	Description	
B. TES-808.00*	Gold Test Kit	\$55.00

GOLD TEST BOX

Securely keep your gold testing supplies together. Hardwood gold test boxes for storing bottles, stones and test needles.

Stock #	Description	Size	
C. TES-802.00	5 Compartment Box	4 1/4" x 2 3/4" x 4"	\$13.75
D. TES-810.10	8 Compartment Box	7 1/2" x 3 1/4" x 4"	\$14.95

TEST NEEDLES

Used with test stones and testing solutions to determine the contents of gold and other precious metals.

Stock #	Description	
E. TES-803.00	Set of 3 (Includes: 10K, 14K, 18K)	\$31.95
TES-804.00	Set of 4 (Includes: 10K, 14K, 18K, Silver)	\$34.95
TES-805.00	Set of 5 (Includes: 8K, 10K, 12K, 14K, 18K)	\$44.95
TES-805.62	Set of 5 (10K, 14K, 18K, 22K, 999)	\$59.95

TEST ACIDS

Our test acids are available in 10K, 14K, 18K and 22K as well as silver and platinum. Sturdy plastic bottles maximize safety and allow the user to easily squeeze out a drop at a time.

Stock #	Description	Size	
F. TES-110.00*	10K	12 grams	\$2.80
G. TES-114.00*	14K	12 grams	\$2.80
H. TES-118.00*	18K	12 grams	\$2.80
I. TES-122.00*	22K	12 grams	\$2.80
J. TES-130.00*	Silver	12 grams	\$2.80
K. TES-132.00*	Platinum	12 grams	\$2.80

* Test acids ship via ground transportation only.

TEST STONES

Genuine natural Arkansas test stones, available in two sizes, are used with solutions and test needles to determine the karat value of articles to be tested. Economy black "glass" stone also available.

Stock #	Description	Size	
L. STN-714.00	Arkansas Stone	2 1/2" x 1 1/2" x 1/4"	\$16.95
M. STN-713.00	Arkansas Stone	2" x 1 1/2" x 1/4"	\$14.95
N. STN-720.00	Economy Test Stone	2" x 1 1/2" x 3/16"	\$3.95

NATURAL RIVER DANUBE TESTING STONES

Our natural testing stones are a great value. Use with solutions and test needles to determine the karat value of articles to be tested. Great quality and economical!

Stock #	Description	Size	
O. STN-718.00	Natural Stone	2 1/2" x 1 1/2" x 1/4"	\$10.95
P. STN-719.00	Natural Stone, Large	2" x 4" x 1/4"	\$14.99

MONEY DETECTIVE

This pen contains a specially-formulated chemical solution that allows the user to verify \$1, \$5, \$10, \$20, \$50 and \$100 bills. Just apply the pen's tip to the currency and press down to release its liquid chemical. A gold "ink" mark verifies legal tender and will disappear in a few days. A black mark which is permanent warns of a suspect bill.

Stock #		
Q. PEN-125.00		\$3.95

M-24 GOLD TESTER

This easy-to-use tester is one of the most advanced in the world. The M-24 precisely determines gold karat values equal to or greater than 9K, 10K, 12K, 14K, 16K, 18K, 20K, 22K, and 24K. Battery operated; comes with a two year warranty.

Stock #	Description	
A. TES-170.00	M-24 Gold Tester	\$219.95
TES-170.10	Replacement Chemical Kit for TES-170.00	\$24.95



A



B

M-18-A9 GOLD TESTER

Precisely determines gold karat values equal to or greater than 9K, 10K, 12K and 18K. Battery operated. Full two year warranty.

Stock #	Description	
B. TES-172.00	M-18-A9 Gold Tester	\$189.95
TES-172.10	Replacement Chemical Kit for TES-172.00	\$21.95



C

ET-18 GOLD TESTER

For slightly more than the cost of a test acid kit, the ET-18 precisely determines gold karat values equal to or greater than 10K, 14K and 18K. Pocket sized and battery operated. Full one year warranty.

Stock #	Description	
C. TES-174.00	ET-18 Gold Tester	\$109.95
TES-172.10	Replacement Chemical Kit for TES-174.00	\$21.95

GEMLIGHT GRADING LIGHT

Customers can actually see for themselves the value they are getting! Gemlight is lightweight and compact, but big enough for the professional to grade diamonds and colored stones. It features a verlux and U.V. long wave light, has a deep grading cavity and a 90% cool white background which makes grading diamonds and detecting fluorescence in colored stones a breeze. Gemlight comes with a protective case, diamond cloth and bulbs. Requires four AA batteries (not included).



Packaged in a protective leather case

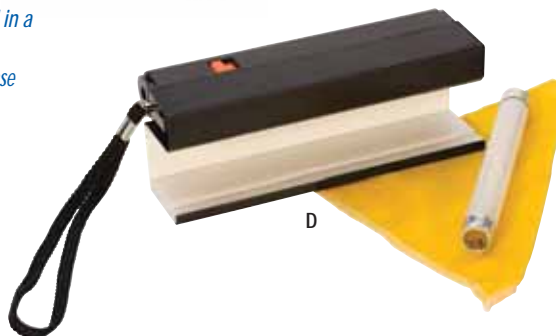

D

Stock #	Description	
D. DIA-338.00		\$89.95

DETACHABLE 10X or 8X LIGHTED MAGNIFIER W/ MAGLITE®

Our lighted magnifier, offers the best illumination yet for viewing, grading or inspecting stones and other small objects. Attached directly to the mini Maglite® is a 10X color corrected compound triplet magnifier made of a high impact nylon composite with rubber eyepiece. The magnifier features a diffuser and one-way reflector so that the viewer's eye is directly above the light giving the best possible view of diamonds, small gemstones, etc. There is nothing else like this on the market today. Also available in 8x for flat viewing of stamps and coins. Patented.

Stock #	Description	
E. DIA-220.00	10X Magnifier w/ Maglite®	\$39.95
DIA-220.10	10X Magnifier Only	\$26.95
DIA-225.00	8X Magnifier for Stamp and Coin w/ Maglite	\$36.95
DIA-225.10	8X Magnifier Only	\$25.95



Now available in 10x for gemstones and 8x for stamps and coins.

E

DARKFIELD DIAMOND VIEW

The perfect way to determine whether diamonds have been fracture filled. Used with a Maglite® mini flashlight, this fine instrument becomes a portable darkfield, allowing the user to identify the fillings and flaws in diamonds.

Featuring a high intensity miniature darkfield and distortion-free 18mm 10X triplet, our Darkfield Diamond View is finished in black oxide for glare free viewing. Comes complete with one Maglite® and is offered in a leatherette pouch.



Determine whether diamonds have been fracture filled with this portable darkfield!

Stock #	Description	
F. DIA-210.00	Darkfield Diamond View w/ Maglite®	\$68.95
LMP-201.00	Maglite® only	\$15.99



F



All the same features,
but with a power cord!



DIAMONDNITE DUAL TESTER

- Test for non-diamond, synthetic Moissanite or genuine diamond with one touch.
- Initial warm-up time eight seconds; recovery time between tests – 1 second!
- Completely portable, uses one nine-volt battery (included).
- Three minute shut-off alert to save battery.
- Simple on-off switch, no tricky adjustments.
- Gray shock resistant housing with easy to read features.

Our DiamondNite with power cord has all the features of the original DiamondNite but now also includes an AC adapter. Still works with a 9 volt battery as well.

Stock #	Description	
DIA-650.00	DiamondNite	\$229.00
DIA-651.00	DiamondNite with Power Cord	\$264.00

RS MIZAR™

RS Mizar offers reliable state-of-the-art gem testers that are simple and easy to use. Test mounted or unmounted stones. Nine volt battery and complete instructions included. Two year warranty.



DIAMOND DETECTIVE

- Simple but precise, test diamonds in rapid succession.
- Metal alert (a long beep if metal is touched rather than stone).
- Large/small switch for testing diamonds over and under eight points.
- Seven second warm-up time with a 150 second shut-off alarm.
- If the stone is a simulant nothing happens, green light indicates diamond.
- Low battery indicator; 9 volt battery included.

Stock #	Description	
DIA-620.00	Diamond Detective	\$99.95



PRESTIGE SERIES II TESTER

- Automatic and manual mode with advanced testing features.
- Identify CZ, diamonds and other stones such as sapphires.
- Linear display for increased information.
- Adjustable gain for small stone sizes.
- Compensation for ambient temperature.
- Fast warm up time – ten seconds!
- Auto shut-off with a push button switch.
- Unique new anti-fade circuit which compensates for stone heating.
- Low battery indicator for accurate readings.

Stock #	Description	
DIA-600.00	Prestige Series II	\$105.95



PRESIDIUM MULTI TESTER

The Presidium Multi Tester (PMuT) utilizes the combine principles of Thermal and Electrical Conductivity from patented technology. The measuring probes together with the electronics circuitries are designed to pick up and segregate data collected from the stones via a customized micro-controller. Within a split second, the test result will be displayed.

- Surface Mount Technology.
- Retractable Tip to ensure the accuracy and consistent pressure between the measuring probe and gemstone.
- No waiting time between tests.
- Clear LED display for Diamond, Moissanite, Simulants and Metal.
- Built-in metal detector.
- Low batteries indicator.
- Automatic power down.

Stock #	Description	
DIA-510.50	Multi Tester	\$286.54

New!

PRESIDIUM

For the past 30 years, the name Presidium has been synonymous with quality and innovation along with the best service in the industry. All Presidium testers use 3 AAA batteries, include carrying case and come with a two year factory warranty.



PRESIDIUM DIAMONDMATE TESTER

The PRESIDIUM DIAMONDMATE utilizes proven thermal conductivity testing method to instantly verify the authenticity of diamonds. Test results are indicated by visual light and audible beeps.

- No waiting time between tests.
- Pocket size.
- Low batteries indicator.
- Metal detector - intermittent beep.
- Measured diamond - continuous beep.
- Low battery consumption.

Stock #	Description	
DIA-510.20	Diamondmate Tester	\$122.80



MOISSANITE TESTER

The presidium Moissanite Tester is designed specifically to identify synthetic Moissanite.

Simply touch the highly sensitive measuring probe to any stone and the reading is instantaneous. Note: This tester is recommended to be used after positive testing result for Diamond with a Thermal Conductivity Tester.

- Operates on 3 x AAA size alkaline batteries.
- Low batteries indicator.
- Measured Moissanite Continuous beep.
- Uses very low operating voltage.
- Low power consumption.
- Pocket size.

Stock #	Description	
DIA-510.10	Moissanite	\$150.64

ORIGINAL DUMONT HIGH-PRECISION TWEEZERS

Universally recognized as the world's finest maker of tweezers, Dumont offers this line of unequalled excellence to users who need the very best. From the finest raw steel to hand finishing and individual inspection, the name Dumont is your guarantee of perfection.

**Original Dumont Tweezer 00**

Stock #	Style	Description	Length	
TWZ-200.04	00	Carbon	4 ³ / ₄ " (120mm)	\$25.24
TWZ-201.04	00	Stainless Steel	4 ³ / ₄ " (120mm)	\$25.75
TWZ-202.04	00	Anti-Magnetic	4 ³ / ₄ " (120mm)	\$27.16

Original Dumont Tweezer 0c

Stock #	Style	Description	Length	
TWZ-201.06	0c	Stainless Steel	3 ¹ / ₂ " (90mm)	\$25.75

Original Dumont Tweezer 1

Stock #	Style	Description	Length	
TWZ-200.10	1	Carbon	4 ³ / ₄ " (120mm)	\$23.00
TWZ-201.10	1	Stainless Steel	4 ³ / ₄ " (120mm)	\$24.00
TWZ-202.10	1	Anti-Magnetic	4 ³ / ₄ " (120mm)	\$24.79

Original Dumont Tweezer 2

Stock #	Style	Description	Length	
TWZ-200.12	2	Carbon	4 ³ / ₄ " (120mm)	\$24.38
TWZ-201.12	2	Stainless Steel	4 ³ / ₄ " (120mm)	\$25.82
TWZ-202.12	2	Anti-Magnetic	4 ³ / ₄ " (120mm)	\$26.14

Original Dumont Tweezer 3

Stock #	Style	Description	Length	
TWZ-200.16	3	Carbon	4 ³ / ₄ " (120mm)	\$24.38
TWZ-201.16	3	Stainless Steel	4 ³ / ₄ " (120mm)	\$26.16
TWZ-202.16	3	Anti-Magnetic	4 ³ / ₄ " (120mm)	\$26.14

Original Dumont Tweezer 3c

Stock #	Style	Description	Length	
TWZ-200.18	3c	Carbon	4 ³ / ₈ " (110mm)	\$24.38
TWZ-201.18	3c	Stainless Steel	4 ³ / ₈ " (110mm)	\$22.75
TWZ-202.18	3c	Anti-Magnetic	4 ³ / ₈ " (110mm)	\$26.14

Original Dumont Tweezer 4

Stock #	Style	Description	Length	
TWZ-200.20	4	Carbon	4 ³ / ₈ " (110mm)	\$26.16
TWZ-201.20	4	Stainless Steel	4 ³ / ₈ " (110mm)	\$28.67
TWZ-202.20	4	Anti-Magnetic	4 ³ / ₈ " (110mm)	\$26.80

Original Dumont Tweezer 5

Stock #	Style	Description	Length	
TWZ-200.22	5	Carbon	4 ³ / ₈ " (110mm)	\$28.35
TWZ-201.22	5	Stainless Steel	4 ³ / ₈ " (110mm)	\$27.05
TWZ-202.22	5	Anti-Magnetic	4 ³ / ₈ " (110mm)	\$29.60

Original Dumont Tweezer 7

Stock #	Style	Description	Length	
TWZ-200.28	7	Carbon	4 ¹ / ₂ " (115mm)	\$30.19
TWZ-201.28	7	Stainless Steel	4 ¹ / ₂ " (115mm)	\$29.50
TWZ-202.28	7	Anti-Magnetic	4 ¹ / ₂ " (115mm)	\$33.70

Original Dumont Tweezer 15a

Stock #	Style	Description	Length	
TWZ-200.60	15a	Carbon	4 ¹ / ₂ " (115mm)	\$80.95
TWZ-201.60	15a	Stainless Steel	4 ¹ / ₂ " (115mm)	\$86.95



GENUINE DUMONT HI-TECH MATTE FINISH TWEEZERS 

This sensational range of tweezers represents a quality unequalled in this price range. Offering an excellent finish and balance from the famous Dumont factory, they are available in either stainless or anti-magnetic stainless steel. They are particularly suitable for electronics, laboratories, light industry, optical and camera assembly and repair. The Dumont Hi-Tech line is a U.S. EURO TOOL exclusive.

Hi-Tech Tweezer 00

Stock #	Style	Description	Length	
TWZ-301.04	00	Stainless Steel	115mm (4½")	\$19.98
TWZ-302.04	00	Anti-Magnetic	115mm (4½")	\$17.00

Hi-Tech Tweezer 0c9

Stock #	Style	Description	Length	
TWZ-301.06	0c9	Stainless Steel	90mm (3½")	\$18.98
TWZ-302.06	0c9	Anti-Magnetic	90mm (3½")	\$13.95

Hi-Tech Tweezer 0c10

Stock #	Style	Description	Length	
TWZ-301.08	0c10	Stainless Steel	100mm (4")	\$18.90
TWZ-302.08	0c10	Anti-Magnetic	100mm (4")	\$14.50

Hi-Tech Tweezer 1

Stock #	Style	Description	Length	
TWZ-301.10	1	Stainless Steel	120mm (4¾")	\$18.90
TWZ-302.10	1	Anti-Magnetic	120mm (4¾")	\$15.65

Hi-Tech Tweezer 2

Stock #	Style	Description	Length	
TWZ-301.12	2	Stainless Steel	120mm (4¾")	\$21.71
TWZ-302.12	2	Anti-Magnetic	120mm (4¾")	\$15.65

Hi-Tech Tweezer 2a

Stock #	Style	Description	Length	
TWZ-301.14	2a	Stainless Steel	120mm (4¾")	\$19.98
TWZ-302.14	2a	Anti-Magnetic	120mm (4¾")	\$15.65

Hi-Tech Tweezer 3

Stock #	Style	Description	Length	
TWZ-301.16	3	Stainless Steel	120mm (4¾")	\$18.47
TWZ-302.16	3	Anti-Magnetic	120mm (4¾")	\$17.78

Hi-Tech Tweezer 3c

Stock #	Style	Description	Length	
TWZ-301.18	3c	Stainless Steel	110mm (4¾")	\$18.90
TWZ-302.18	3c	Anti-Magnetic	110mm (4¾")	\$17.78

Hi-Tech Tweezer 5

Stock #	Style	Description	Length	
TWZ-301.22	5	Stainless Steel	110mm (4¾")	\$23.35
TWZ-302.22	5	Anti-Magnetic	110mm (4¾")	\$21.01

Hi-Tech Tweezer 6

Stock #	Style	Description	Length	
TWZ-301.26	6	Stainless Steel	115mm (4½")	\$34.95
TWZ-302.26	6	Anti-Magnetic	115mm (4½")	\$35.93

Hi-Tech Tweezer 7

Stock #	Style	Description	Length	
TWZ-301.28	7	Stainless Steel	115mm (4½")	\$22.75
TWZ-302.28	7	Anti-Magnetic	115mm (4½")	\$21.05

Hi-Tech Tweezer AA

Stock #	Style	Description	Length	
TWZ-301.40	AA	Stainless Steel	125mm (4¾")	\$17.95
TWZ-302.40	AA	Anti-Magnetic	125mm (4¾")	\$17.00

Hi-Tech Tweezer H

Stock #	Style	Description	Length	
TWZ-301.43	H	Stainless Steel	90mm (3½")	\$19.50
TWZ-302.43	H	Anti-Magnetic	90mm (3½")	\$17.70

Hi-Tech Tweezer SS

Stock #	Style	Description	Length	
TWZ-301.56	SS	Stainless Steel	140mm (5½")	\$18.45
TWZ-302.56	SS	Anti-Magnetic	140mm (5½")	\$17.00



Swiss Made

IDEAL-TEK SWISS TWEEZERS



Introducing Ideal-tek; a fixture for over 40 years in the manufacturing of high quality precision tweezers the jewelry and watch making industries have come to expect from a Swiss manufacturer. EURO TOOL is proud to be the exclusive distributor of these fine instruments in North America. Ideal-tek products offer precision balance, alignment, symmetry along with smooth surfaces to provide the user an ideal experience when using these fine instruments. Optimum quality assured through ISO certification.

IDEAL-TEK STAINLESS STEEL TWEEZERS

- Stainless steel, magnetizable.
- Used where strength/hardness are of primary concern.
- Made of high quality carbon steel along with chromium.
- Typical applications include watch making, jewelry, medical and laboratory in mild chemical environments.

Stock #	Style	Description	Length	
A. TWZ-311.04	00	Inox (Stainless Steel)	4 ³ / ₄ " (120mm)	\$18.23
B. TWZ-311.10	1	Inox (Stainless Steel)	4 ³ / ₄ " (120mm)	\$18.45
C. TWZ-311.16	3	Inox (Stainless Steel)	4 ³ / ₄ " (120mm)	\$18.00
D. TWZ-311.18	3C	Inox (Stainless Steel)	4 ³ / ₈ " (110mm)	\$18.00
E. TWZ-311.22	5	Inox (Stainless Steel)	4 ³ / ₈ " (110mm)	\$21.75
F. TWZ-311.28	7	Inox (Stainless Steel)	4 ¹ / ₂ " (115mm)	\$23.25

IDEAL-TEK STAINLESS STEEL ANTI-MAGNETIC TWEEZERS

- Stainless steel, non-magnetizable
- Generally used where corrosion resistance and toughness are required.
- Corrosion resistant to chemicals and acids.
- Made of chromium, nickel, molybdenum with low carbon content.

Typical applications include watch making, jewelry, medical and laboratory in moderate chemical environments.

Stock #	Style	Description	Length	
G. TWZ-312.04	00	Anti-Magnetic	4 ³ / ₄ " (120mm)	\$16.20
H. TWZ-312.10	1	Anti-Magnetic	4 ³ / ₄ " (120mm)	\$15.95
I. TWZ-312.16	3	Anti-Magnetic	4 ³ / ₄ " (120mm)	\$15.95
J. TWZ-312.18	3C	Anti-Magnetic	4 ³ / ₈ " (110mm)	\$15.95
K. TWZ-312.22	5	Anti-Magnetic	4 ³ / ₈ " (110mm)	\$19.25
L. TWZ-312.28	7	Anti-Magnetic	4 ¹ / ₂ " (115mm)	\$20.80
M. TWZ-312.40	AA	Anti-Magnetic	5 ¹ / ₈ " (130mm)	\$11.85
N. TWZ-312.56	SS	Anti-Magnetic	5 ¹ / ₂ " (140mm)	\$15.95

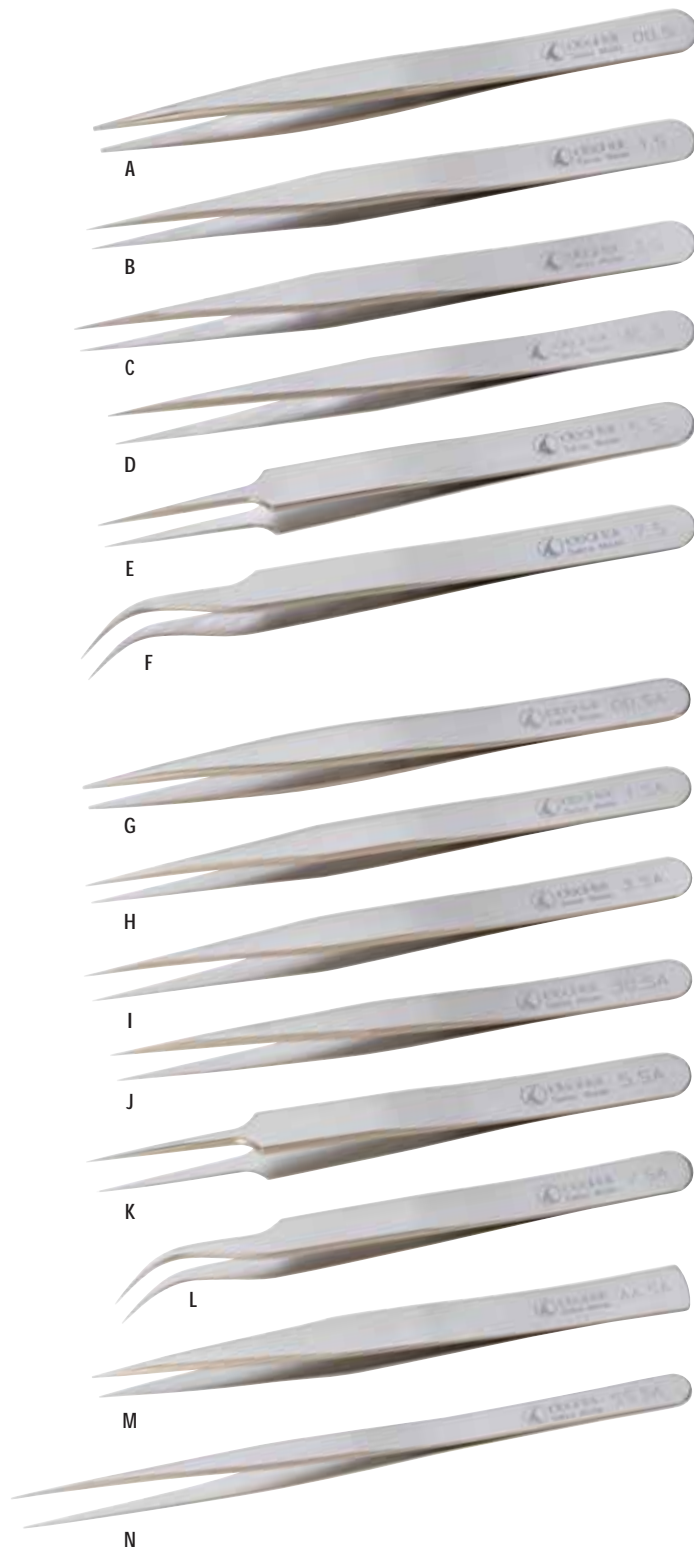

*Protect your
tweezer investment*

LEATHER TWEEZER PROTECTOR

The ideal companion to your quality tweezers. No more ruining expensive tweezers by dropping them and bending the tips. Keep the tips safe and secure by storing them in our leather tweezers pouches. Great for pocket as well as bench storage.

Stock #	Description	Length	
O. PKG-600.01	Small	5"	\$1.50
P. PKG-600.02	Large	6 ¹ / ₂ "	\$1.45

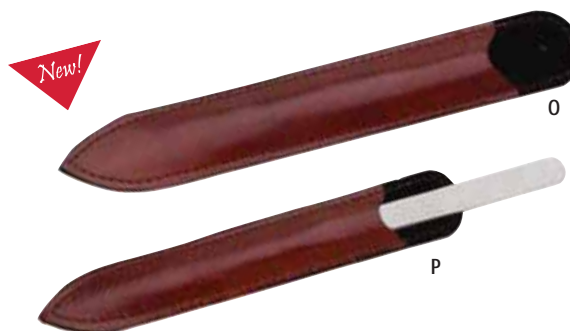

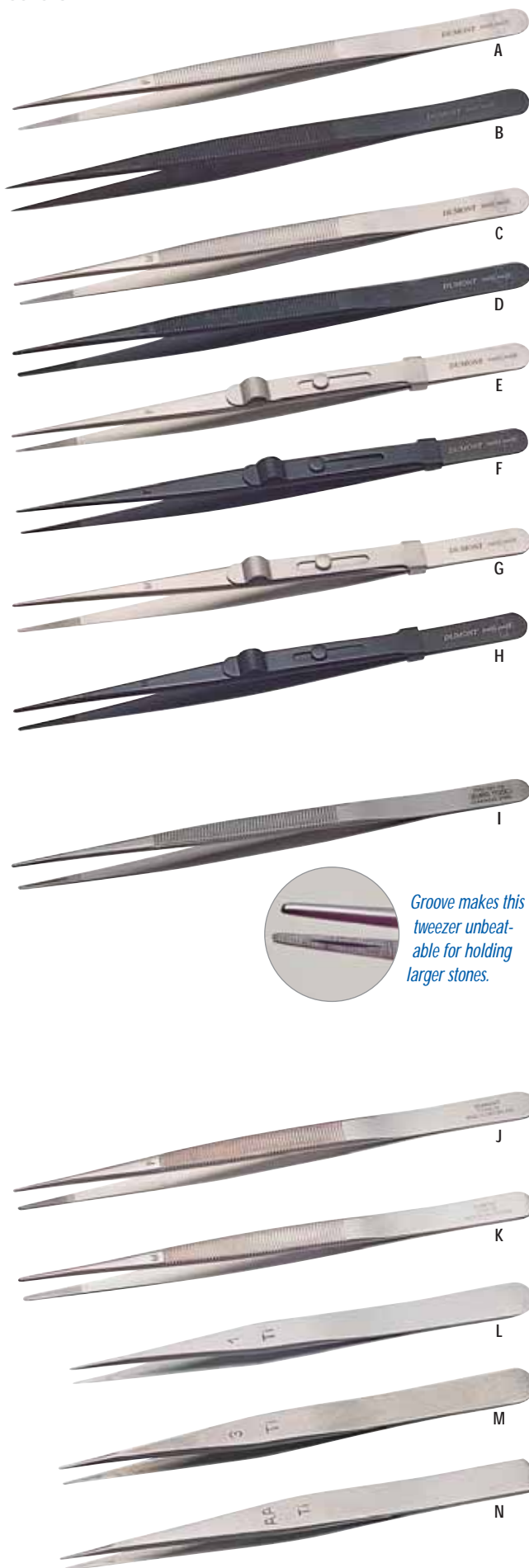

ORIGINAL DUMONT DIAMOND TWEEZERS – SWISS-MADE EXCLUSIVE

Distributed exclusively by EURO TOOL, Dumont Diamond tweezers have finely serrated jaws to hold stones and small objects firmly. They offer an improved locking system, a superb finish and balance with the legendary Dumont flexibility. They're simply the best stone tweezers in the world! 6½" long for a fine touch and improved balance. Now made of thinner stock to be lighter and more flexible. All are matte finish.

Stock #	Description	Style	
A. TWZ-101.70	Stainless Steel Matte	Fine Points	\$22.70
B. TWZ-103.70	Black Matte	Fine Points	\$21.10
C. TWZ-101.74	Stainless Steel Matte	Medium Points	\$22.70
D. TWZ-103.74	Black Matte	Medium Points	\$21.10
E. TWZ-101.72	Stainless Steel Matte	Fine Points, Locking	\$26.95
F. TWZ-103.72	Black Matte	Fine Points, Locking	\$28.15
G. TWZ-101.76	Stainless Steel Matte	Medium Points, Locking	\$26.95
H. TWZ-103.76	Black Matte	Medium Points, Locking	\$28.15

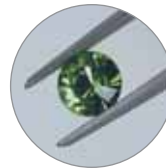

Dumont's Diamond Tweezers have a special grid serration pattern to give them extra holding power.

MEDIUM POINTS GROOVED TWEezer

A groove runs down the middle of Dumont's medium point diamond tweezers, making it unbeatable for holding larger stones. Made of stainless steel.

Stock #	Description	Length	
I. TWZ-101.75	Stainless Steel Matte w/ Groove	6½"	\$25.30

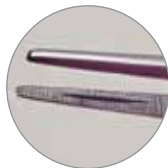

Groove makes this tweezers unbeatable for holding larger stones.

DUMONT TITANIUM TWEEZERS - 100% NON-MAGNETIC

Dumont combines its high standards of excellence with the outstanding features of titanium to produce an unequalled line of titanium tweezers. Titanium is a space age metal used in aircraft and resists all types of rust and corrosion. Titanium is 40% lighter than steel and 60% stronger, giving these tweezers a light touch and strong fine points.

Stock #	Description	Style	Length	
J. TWZ-105.70	Titanium Diamond	Fine Point (F)	6¼" (160mm)	\$32.05
K. TWZ-105.74	Titanium Diamond	Medium Point (M)	6¼" (160mm)	\$32.05
L. TWZ-120.10	Titanium Precision	#1	4¾" (120mm)	\$27.95
M. TWZ-120.16	Titanium Precision	#3	4¾" (120mm)	\$27.95
N. TWZ-120.40	Titanium Precision	#AA	4⅞" (125mm)	\$27.95



Groove in the tip makes holding stones easy and secure!

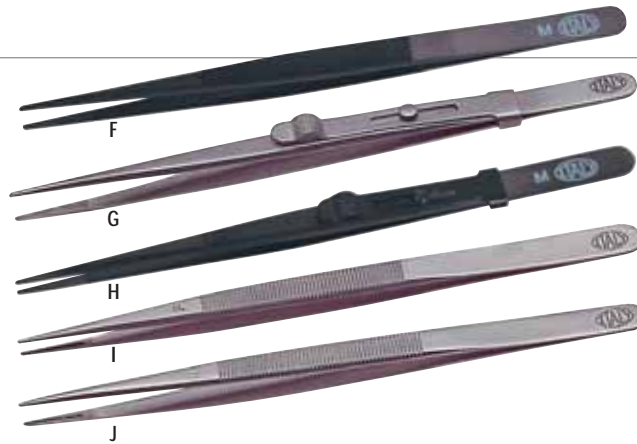
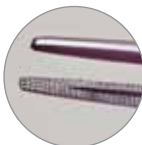

ALLEGRO DIAMOND TWEEZERS

Our Italian Diamond Tweezers are a reasonably priced line of tweezers which maintains a high standard of quality. Manufactured of stainless steel with a light touch and good flexibility, this line incorporates finely serrated points to hold diamonds and other stones securely during sorting or for viewing by customers. All tweezers are 6 1/2" (160mm) for fine balance and easy handling. The silver are a non-glare matte finish. The black are a flat, non-glare matte finish. Available in three different point sizes, either locking or non-locking. With EURO TOOL your satisfaction is assured.

Stock #	Description	Style	Length	
A. TWZ-171.70	Stainless Steel	Fine Points (F)	6 1/2" (160mm)	\$9.80
B. TWZ-173.70	Black	Fine Points (F)	6 1/2" (160mm)	\$12.30
C. TWZ-171.72	Stainless Steel	Fine, Locking (FL)	6 1/2" (160mm)	\$12.30
D. TWZ-173.72	Black	Fine, Locking (FL)	6 1/2" (160mm)	\$14.35
E. TWZ-171.74	Stainless Steel	Medium Points (M)	6 1/2" (160mm)	\$9.80
F. TWZ-173.74	Black	Medium Points (M)	6 1/2" (160mm)	\$12.30
G. TWZ-171.76	Stainless Steel	Medium, Locking (ML)	6 1/2" (160mm)	\$12.30
H. TWZ-173.76	Black	Medium, Locking (ML)	6 1/2" (160mm)	\$14.35
I. TWZ-171.73	Stainless Steel Grooved	Fine	6 1/2" (160mm)	\$12.30
J. TWZ-171.75	Stainless Steel Grooved	Medium	6 1/2" (160mm)	\$12.30

K. PARALOX TWEEZERS

Newly engineered Paralox tweezers are perfect for handling gemstones. With parallel grooves rather than conventional criss-cross pattern, Paralox tweezers hold stones more securely and at the proper angle, particularly small stones, giving the user confidence when sorting or showing. Because of the tapered shoulder design, they have an exceptionally light touch. Made of stainless steel and available in fine, medium and broad in brushed stainless.



Stock #	Description	Style	Length	
TWZ-191.70	Stainless Steel	Fine	6 1/4" (160mm)	\$5.45
TWZ-191.74	Stainless Steel	Medium	6 1/4" (160mm)	\$5.45
TWZ-191.77	Stainless Steel	Broad	6 1/4" (160mm)	\$5.45

SOFT TOUCH TWEEZERS

We've improved our Allegro Diamond Tweezers by adding a thin layer of PVC coating to the tips for extra gripping power without damage to soft stones. In addition, the coating is black to provide optimal viewing of the stone and not the tweezer. Available in medium tips, both locking and non-locking, stainless steel.

Stock #	Description	Style	Length	
L. TWZ-161.74	Non-locking	Medium	6 1/2" (160mm)	\$10.25
M. TWZ-161.76	Locking	Medium	6 1/2" (160mm)	\$12.25

ECONOMY DIAMOND TWEEZERS

Fine and medium point economy diamond tweezers offered in both stainless steel and black matte finish. We assure you that our cheap is better than their cheap!

Stock #	Description	Style	Length	
N. TWZ-701.70	Stainless Steel	Fine	6 1/2" (160mm)	\$2.50
O. TWZ-701.74	Stainless Steel	Medium	6 1/2" (160mm)	\$2.50
P. TWZ-703.70	Black Matte	Fine	6 1/2" (160mm)	\$2.50
Q. TWZ-703.74	Black Matte	Medium	6 1/2" (160mm)	\$2.50

CABACHON TWEezer

This unique tweezer is specially made to hold cabochons and other large stones. Featuring a 1" wide opening, the protective coating prevents scratches and makes for a sure grip on the stone.



Stock #	Description	Length	
R. TWZ-968.00	8"		\$4.95



Safely holds cabochons and other large stones.



A



B



C

New low price!



D



E



F

EXCLUSIVE



G



H

EXCLUSIVE

BEAD TWEEZER

Great bead handling tool. Nicely rounded ends on a sturdy nickel tweezer will make handling almost any size bead an easier task.

Stock #	Length	
A. TWZ-620.00	4 ⁵ / ₈ "	\$3.95

PEARL/STUD TWEEZERS

Self-locking stainless steel tweezers feature one padded jaw and one with a slit, which make them ideal clamps when gluing pearls. Tweezers apply just enough pressure to insure a superior hold. You may want several to make the job quicker and easier.

Stock #	Length	
B. TWZ-680.00	4 ³ / ₈ "	\$4.90

PEARL-HOLDING TWEEZER

This epoxy-coated tipped tweezers is a must when sorting pearls or other round stones.

Stock #	Length	
C. TWZ-104.84	5 ³ / ₄ "	\$5.95

BEADING TWEEZER

A bead tweezer designed specifically for sorting and handling beads and delicate pearls. This tweezer absolutely cannot scratch because the tip is nylon. The shank is made of high-grade stainless steel for a light touch with excellent grip.

Stock #	Length	
D. TWZ-104.50	6 ¹ / ₄ "	\$8.95

"SOFTIE" STONE TWEEZER

Never worry about damaging the edges of soft stones with our "Softie" stone tweezer. It features nylon attached to a fine stainless steel shank that gives this stone handling tool a nice touch.

Stock #	Length	
E. TWZ-165.10	6 ¹ / ₂ "	\$5.95



BEAD HANDLING TWEEZER

EURO TOOL has been known for tweezers and tweezers innovation for years, so we put our heads to work on this one—how to best remove all sizes of beads from kits, bottles and trays without spilling or damaging them. The answer is proper engineering; in this case long tweezers with half round jaws so that the user can go straight down and pick up the desired bead or stone. This design handles any shape or size without damage. Made of stainless steel

with a nice light touch, you'll get years of service from this exclusive EURO TOOL design, which can handle seed beads and beads up to 10.0 mm in diameter.

Stock #	Length	
F. TWZ-104.30	6 ¹ / ₄ " (160mm)	\$6.95

DIAMOND TWEEZER WITH SHOVEL

Our stone/bead shovel added onto a medium tip serrated stone tweezer allows more versatility and better handling of stones and beads. This tweezer is made of stainless steel with serrated tips. The combination of stone shovel and tweezer is convenient and time saving.

Stock #	Length	
G. TWZ-705.70	7 ¹ / ₈ "	\$4.95

WIRE STRAIGHTENING TWEEZER

As an economical alternative to our nylon jaw pliers, we now offer nylon jaw tweezers. Our new tweezers take up less space, insure that the user won't grab the wire too firmly, and are easy to use. Made of stainless steel with quality nylon jaws.

Stock #	Length	
H. TWZ-748.00	5 ¹ / ₄ "	\$7.95

WOLF CROSS-LOCKING TWEEZER with GROOVE

A very small horizontal notch in the tip of these cross-locking tweezers allows you to securely hold even the finest of wire when soldering or shaping. Heat-resistant fiber grips.



Stock #	Description	Length	
A. TWZ-738.00	Cross-Locking w/Groove	6½" (165mm)	\$5.95

FIBER-GRIP SOLDERING TWEEZERS

All with heat-resistant fiber grips, the polished steel jaws are available either straight or curved. Strong cross-locking tweezers hold your work securely. The overall length is 6¼" (160mm). The jumbo model is 8" (200mm).

Stock #	Description	Length	
B. TWZ-740.00	Straight, Cross Locking	6¼" (160mm)	\$3.35
TWZ-740.04	Straight, Cross Locking	4½" (115mm)	\$2.10
C. TWZ-741.00	Curved, Cross Locking	6¼" (160mm)	\$3.35
D. TWZ-744.00	Straight	6¼" (160mm)	\$2.85
E. TWZ-745.00	Jumbo, Straight	8" (200mm)	\$3.45

TITANIUM TWEEZERS

Available with or without fiber grips, Titanium Cross Locking Tweezers will not contaminate platinum or other precious metals when soldering. 6½" (165mm) in length, tweezers come to a fine point with finely serrated jaws for holding items securely.

Stock #	Description	Length	
F. TWZ-950.00	Titanium Tweezers	6½" (165mm)	\$24.95
TWZ-950.10	Titanium Tweezers w/ Fiber Grip	6½" (165mm)	\$26.95

Every Jeweler uses tweezers, and some need to be the finest quality available – others can be inexpensive for soldering, etc. However, we try to give you the very best at each price category.

ECONOMY TWEEZERS

Our economy-priced tweezers can be used for soldering and various jobs where fine point tweezers would bend. They're an extremely fine tweezers value.

Stock #	Description	Length	
G. TWZ-735.40	AA Medium, Flexible Shanks	4¾" (120mm)	\$2.35
H. TWZ-735.44	MM Medium, Thick Shanks	4¾" (120mm)	\$2.35
I. TWZ-735.48	OO Medium, Thick Shanks	4¾" (120mm)	\$2.35

SPECIAL ECONOMY TWEEZERS

Utility grade tweezers ideal for servicing and repair of jewelry, electronic components or hobby items. These anti-magnetic, stainless steel tweezers are offered to you at exceptional values without compromising quality.

Stock #	Style	Length	
J. TWZ-736.10	1	4¾" (120mm)	\$1.85
K. TWZ-736.12	2	4¾" (120mm)	\$1.85
L. TWZ-736.16	3	4¾" (120mm)	\$1.85
M. TWZ-736.18	3c	4½" (115mm)	\$1.85
N. TWZ-736.22	5	4½" (115mm)	\$1.85
O. TWZ-736.28	7	4½" (115mm)	\$1.85
P. TWZ-736.42	GG	5" (127mm)	\$1.85

JUMBO AA TWEEZER

AA jumbo tweezers are a full 6¼" long with medium points to do bigger jobs. The length helps hold items when soldering.

Stock #	Description	Length	
Q. TWZ-735.42	AA Medium, Jumbo Tweezer	6¼" (160mm)	\$2.45

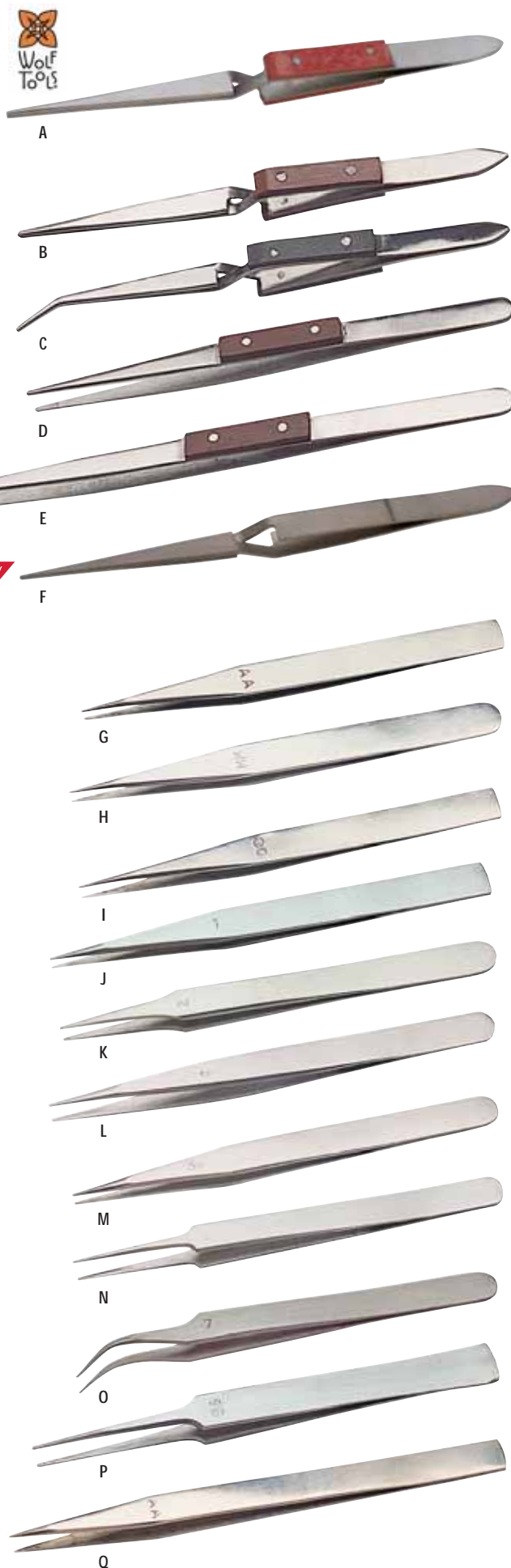



A



EXCLUSIVE

B

Use our copper tongs for safe, dependable use. Won't contaminate pickling acid/solutions.



C



D



E



F

Extra wide to accommodate double ring shanks!



G



H



I

EXCLUSIVE

J

STAND UP CROSS-LOCK TWEEZER

Cross-lock tweezer stands flat to hold work about 1" off soldering boards leaving your hands free. Straight serrated tips hold work securely. Made of stainless steel.

Stock #	Description	Length	
A. TWZ-941.00	Cross-Lock Tweezer	6 $\frac{1}{4}$ "	\$2.95

COPPER PICKLING TWEEZERS

Our copper pickling tweezers provide more strength than ordinary copper tweezers. Made to lift heavier objects, legs are less flexible than others. For years people have been dropping articles because copper tweezers flex too much, causing a lack of grip. Available in two styles – straight version is designed for easy retrieval with serrated jaws and the curved version offers a reinforcing rib which runs the length of the tweezer making it far more sturdy, easier to use and safer too! You'll be amazed by the difference. A EURO TOOL exclusive.

Stock #	Description	Length	
B. TWZ-958.00	Straight, Serrated	8 $\frac{1}{2}$ "	\$6.95
C. TWZ-959.00	Curved, Reinforced	8 $\frac{1}{2}$ "	\$6.95

COPPER TONGS

For use with pickling solutions. Rigid and well-made.

Stock #	Description	Length	
D. TWZ-920.01	Fishtail	8 $\frac{1}{2}$ "	\$6.45
E. TWZ-920.02	Curved	8 $\frac{1}{2}$ "	\$6.45

HEAD and SHANK TWEEZERS

This is the ideal tool to hold settings and shanks together for accurate soldering. The slide lock, serrated pad and Dumont quality make this a winner. Extra wide model also available for accommodating wider or double ring shanks.

Stock #	Description	Length	
F. TWZ-600.00	Dumont, Swiss-Made	5 $\frac{1}{2}$ " (140mm)	\$43.95
TWZ-600.10	Economy Model	5 $\frac{1}{2}$ " (140mm)	\$9.55
G. TWZ-600.15	Extra Wide	5 $\frac{1}{2}$ " (140mm)	\$12.95

RING-SET SOLDERING TWEEZER

Saves time and makes soldering ring shanks together easy, fast and simple. Rings are accurately positioned for clean, quick jobs. This is a valuable aide for the modern jeweler.

Stock #	Description	Length	
H. TWZ-605.00	Ring Set Soldering Tweezer	4 $\frac{1}{2}$ " (115mm)	\$3.80

CROSS-LOCKING TUNGSTEN TIP TWEEZER

This new and handy self-locking tweezer offers tungsten tips, which will not contaminate other metals, including platinum. Tips are replaceable by the pair. Unit fits nicely onto a third hand base.

Stock #	Description	Length	
I. TWZ-750.00	Tungsten Tip Tweezer	7 $\frac{3}{4}$ "	\$38.95
TWZ-750.02	Replacement Tips (pair)		\$7.95



HALF-SHANK TWEEZER

Made specifically for the difficult task of holding half or quarter shanks in place while soldering with no fumbling or misalignment. Another EURO TOOL exclusive invented by a bench jeweler. Made of stainless steel with a steel base, this tool is good for other applications where a gentle but firm hold is necessary. Top arm of the tweezer swings out of the way when not used to hold half or quarter shanks.

Stock #	Description	
J. TWZ-602.00	Tweezer with Base	\$19.95
TWZ-602.10	Tweezer Only	\$16.95



UTILITY TWEEZER SET

Four popular tweezers in a handy PVC pouch. Great for various jobs where ultimate precision is not required, particularly soldering. The set features the following styles: 4¾" general purpose, 6½" insulated cross-locking, 6½" bent nose and 4½" cross-locking tweezers.

Stock #		
A. TWZ-700.00		\$9.95

UTILITY TWEEZERS

Our utility tweezers are selected for quality at reasonable prices. Excellent for all soldering and utility applications. Each is stainless steel and designed to do a specific job.

Stock #	Description	Length	
B. TWZ-940.00	Serrated, Blunt	5"	\$2.75
C. TWZ-944.00	Smooth Points	7"	\$2.75
D. TWZ-945.00	Smooth Curved Points	6½"	\$2.75
E. TWZ-949.00	Slide Locking, Serrated, Blunt	6½"	\$2.75



CROSS LOCK UTILITY TWEEZERS

Tweezers with cross-locking action easily and securely hold items without finger pressure. Ideal to use for soldering as well as a variety of other general applications.

Stock #	Description	Length	
F. TWZ-935.00	Negative Locking, Fine	4¾"	\$2.55
G. TWZ-947.00	Neg. Locking, Serrated, Blunt	6½"	\$2.75
H. TWZ-948.00	Neg. Locking, Serrated, Medium	6½"	\$2.75



12 PIECE TWEEZER SET

This twelve piece set of stainless steel anti-magnetic tweezers offers the user complete variety for any job. Ground and polished to perfection, this set has a nice touch for fine work in any environment. Points are perfectly aligned for a firm grip on the smallest articles.

Stock #		
I. TWZ-700.12		\$13.95



FOUR PIECE PMC KIT

Our tweezer/pick set is perfect for PMC and a variety of other applications. With a double ended pick for cleaning, a double ended carver for shaping and smoothing, a #7 tweezer for positioning and handling and a negative locking tweezer for holding or clamping one can do many jobs quickly and efficiently. All tools are stainless steel for years of service.

Stock #		
J. TWZ-700.40		\$9.95



Other tools for metal clay shown on 175-177.

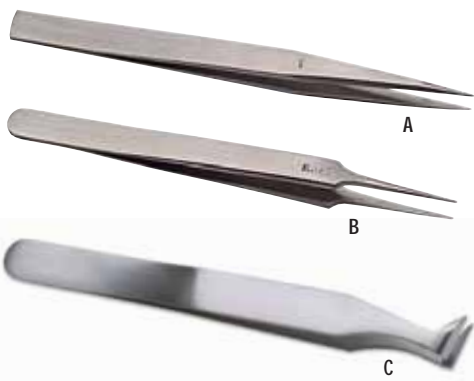

Caution: Do not use diamond coated tweezers on gemstones



BEADING/UTILITY TWEEZERS

The No. 1 shape tweezer and the bead stringing tweezer No. 5 are economical and well-finished in stainless steel.

Stock #	Style	Length	
A. TWZ-735.10	No. 1	4 ³ / ₄ " (120mm)	\$1.80
B. TWZ-735.22	No. 5	4 ¹ / ₂ " (115mm)	\$2.80

15A CUTTING TWEezer

This handy cutting tweezers is made to closely cut small copper wires or plastic sprues. The best part is the price, as Swiss-made cutting tweezers sell for well above this one. Made of stainless steel. Length 4¹/₂".

Stock #	Style	Length	
C. TWZ-801.60	15a	4 ¹ / ₂ "	\$9.95

SPLIT RING TWEezer

An easy-to-use stainless steel tweezers for opening small to medium split rings. Just put the split ring under the claw and squeeze. It's simple and fast.

Stock #	Description	Length	
D. TWZ-608.00	Split Ring	4 ¹ / ₂ "	\$5.95

PLASTIC TWEezer

This synthetic, non-conductive tweezers is ideal for changing watch batteries.

Stock #	Length	
E. TWZ-799.00	5"	\$1.10

10" STEAM TWEezer

A new concept in steam tweezers - no PVC to melt and peel off. Instead we have attached high impact nylon onto the jaws to prevent scratching. 10" length stainless steel tweezers keeps user safely away from hot steam.

Stock #	Length	
F. TWZ-960.00	10"	\$7.95

STEAM TWEEZERS

Chrome plated steam cleaning tweezers with thick coating on tips holds items securely.

Stock #	Length	
G. TWZ-954.00	8"	\$4.95
H. TWZ-955.00	10"	\$5.50
I. TWZ-957.00	12"	\$5.95

DIAMOND-COATED TWEEZERS

Diamond-coated tweezers grip as no other can! Each tweezers is made of stainless steel and coated with extremely fine diamond particles on the inside tips. This tweezers should be used for special applications where gripping is essential. CAUTION: Do not use on gemstones.

Stock #	Description	Length	
J. TWZ-104.87	Medium Point	6 ¹ / ₂ "	\$27.95

CURVED TWEezer with PIN

For handling various jobs, this tweezers features a pin interlock which keeps the jaws from twisting when doing heavier work.

Stock #	Length	
K. TWZ-861.00	6"	\$3.65

SCREW-HOLDING TWEezer

Ideal for battery clamps and screws, the V-shaped notch makes it possible to hold the smallest screws for assembly or attaching battery straps in watches.

Stock #	Length	
L. TWZ-808.00	4 ³ / ₈ "	\$7.25

TWEezer with URETHANE JAWS

Stainless steel tweezers with urethane jaws are great for diamonds and soft stones. Urethane provides a secure grip, and is light, but non-reflective and will not damage the edges of soft stones. Tips come to a nice 2.0 mm point.

Stock #	Length	
M. TWZ-175.10	6" (155mm)	\$9.95

WATCH WINDERS

These scientifically made watch winders look great for the shop or even for home use. The outer box is made of highly polished wood, with a dark lacquered finish. Both models have a window for easy viewing, and a padded lining on the inside so you'll never scratch your watch. Cushions allows for large or regular size watches. State-of-the-art motors have four options for spinning watches using the switch conveniently located under the lid. Best of all, the units can run on six "AA" batteries (not included) or an AC adapter (included). Your automatic watch need never run down again, so no winding, date changing, etc.

Stock #	Description	
A. WAT-351.00	Single Unit	\$74.75
B. WAT-352.00	Double Unit	\$129.95

BATTERY TESTER

Compact but very accurate, this unit tests watch, calculator and camera batteries as well as lithium and mercury cells. Priced right and the quality is assured.

Stock #	Size	
C. BAT-445.00	3 7/8" x 2 1/2"	\$10.95

WATCH ANALYZER

The newest in innovative watch analyzers now offered by EURO TOOL, allows users to tell whether the step motor is working or if the battery is dead – without opening the watch. Unlike competitive testers – at a much higher price – this analyzer will test the coil as well. This compact unit is a great tool for watchmakers and jewelers as well as department stores. 9 volt battery included.

Stock #	
D. BAT-200.00	\$39.95

POWERPEN™ BATTERY SAVER

The PowerPen™ battery saver is the only way to clean batteries and conductive terminals. Non-toxic and non-corrosive, the PowerPen™ contains an all natural cleaner, which leaves a slight residue but does not impede conductivity. To the contrary, it removes oxidation. And the residue left behind keeps the battery or contact from oxidizing, which lowers contact resistance, thereby giving the battery longer life. The fine tip makes it great to use on all types of watch batteries. Good for 50-75 applications, PowerPen™ can be used on all batteries except zinc air batteries.



Stock #	
E. BAT-600.00	\$3.99

STATICWISK™ ANTI-STATIC BRUSH

Safe and effective dust and static remover, the StaticWisk™ will provide years of use in cleaning optics, cameras, plastics, glass, watch and clock dials, and crystals. Washable StaticWisk™ is made from a blend of special soft, natural hair and a conductive fiber.

Stock #	Description	
F. BRS-972.00	3/4" (20mm) Anti-Static Brush	\$6.95
BRS-973.00	1 1/4" (30mm) Anti-Static Brush	\$15.95

CLEAN SWABS

Made in Switzerland, these high quality swabs are ideal for precision cleaning and applicator needs for the watch and clock industry or where a lintless applicator is required. **Sealed Foam Swabs** with open cell structure give the best solvent holding ability and great for general purpose use. The durable **Sealed Polyester Swabs** are acid and solvent resistant and ideal for tough scrubbing around raised shapes or delicate cleaning applications. For precise applications, the **Wrapped Foam Swabs** deliver superior abrasion resistance for removal of tough contaminants. The small tip allows use in very tight tolerance areas, while the pointed end works as a pick. Available in packs of 12 or swab assortment.

Stock #	Description	
CLN-912.00	12pc Assortment, (3 ea style)	\$5.75
G. CLN-907.01	Sealed Foam Swabs, bg/12	\$5.30
H. CLN-907.02	Sealed Foam Swabs – Pointed, bg/12	\$5.30
I. CLN-908.01	Sealed Polyester Swabs – Round Tip, bg/12	\$5.30
J. CLN-909.01	Wrapped Foam Swabs – Double-ended, bg/12	\$6.25

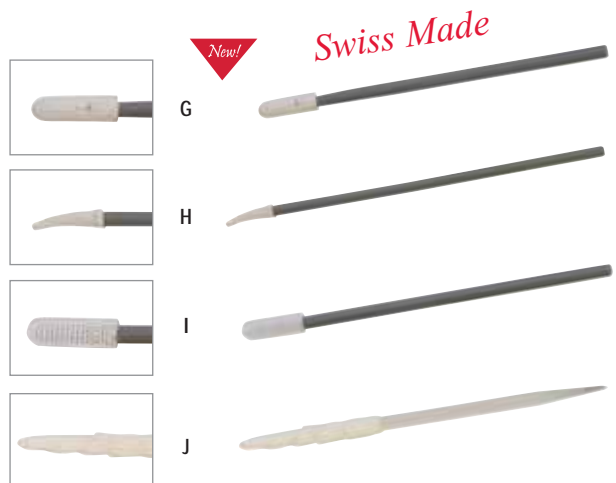

Includes only professional quality tools.



A



B

Battery change kit includes:

- 1.00mm Straight Blade Screwdriver
- Spring Bar Tool
- Plastic Tweezers (for handling batteries)
- Scratch Brush (for cleaning battery cavity)
- Screw-Back Case Opening Wrench
- 1.20mm Phillips Screwdriver
- Bench Knife (for pop-off case backs)
- Chain Nose Plier (optional)
- 5" x 5" Selyvt Cloth (optional).

DELUXE UNIVERSAL BATTERY CHANGE KIT

The right tools in a neat kit which ships well and keeps tools from being lost. The pouch is faux leather with zipper and elastic bands to keep tools securely in place. Comes with a list of tools so if one is lost, you'll know which to replace.

Stock #	Description	
A. BAT-510.00	Deluxe Universal Battery Change Kit	\$28.95

Kit includes the following tools:

BRS-294.00	Fiberglass Scratch Brush	SCR-261.00	1.00mm Screwdriver
CWR-777.00	Pocket Case Wrench	SCR-261.60	1.60mm Screwdriver
KNF-975.00	Case Opening Knife	SCR-831.20	1.20mm Phillips Screwdriver
POL-908.03	5" x 5" Polishing Cloth	TWZ-799.00	Plastic Tweezer
SBT-100.00	Spring Bar Tool		

BATTERY CHANGING KITS

If you change watch batteries, you will appreciate this kit. It has everything needed to do the job quickly in a convenient roll-and-tie pouch. See text under picture for items included in kit.

Stock #	Description	
BAT-500.10	Basic Battery Change Kit	\$20.95
B. BAT-500.00	Battery Change Kit with Selyvt Cloth	\$23.55
BAT-500.05	Kit with Selyvt Cloth and Chain Nose Plier	\$25.85

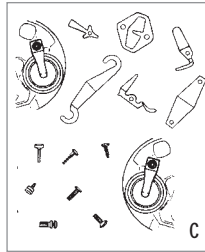

C. BATTERY CLAMP and SCREW ASSORTMENTS

A great addition to our battery change kits.

Stock #	Description	
WAT-400.05	50 pc. Battery Clamp Asst.	\$25.25
WAT-400.10	100 pc. Battery Clamp Screw Asst.	\$19.95



Featuring:

- One-of-a-kind authentication hologram.
- Clear, bold model numbers.
- Easy-to-Open Pill Packaging - much easier than blister packaging.
- Individual UPCs on back of package.
- Maintains Maxell's unique color coding system.
- 30% lighter than previous packaging.
- Smaller card size fits popular watch battery storage systems.

MAXELL BATTERIES

Maxell batteries are known worldwide for their performance and reliability and now you can order them from EURO TOOL with your other needs. We've listed the most popular sizes, but other numbers are available upon request. Priced per piece, sold in packs of 5.

Stock #	Description	
BAT-M321	# 321 (SR616SW)	\$0.84
BAT-M364	# 364 (SR621SW)	\$0.49
BAT-M371	# 371 (SR920SW)	\$0.82
BAT-M377	# 377 (SR626SW)	\$0.49
BAT-M379	# 379 (SR521SW)	\$0.64
BAT-M395	# 395 (SR927SW)	\$0.82
BAT-MCR1216	CR1216	\$1.10
BAT-MCR2016	CR2016	\$0.69
BAT-MCR2025	CR2025	\$0.69
BAT-MCR2032	CR2032	\$0.69
BAT-MLR44	LR44	\$0.54

BATTERY REFERENCE CHART

Maxell	Energizer (Eveready)	Model	Recommended Applications	Dimensions Diameter (mm)	Height (mm)	Nominal Voltage (V)	Capacity (mAh)
SR616SW	321	Silver Oxide	Low Drain Watch	6.8	1.65	1.55	15, 16
SR621SW	364	Silver Oxide	Low Drain Watch	6.8	2.15	1.55	18, 21, 23
SR920SW	371	Silver Oxide	Low Drain Watch	9.5	2.05	1.55	39
SR626SW	377	Silver Oxide	Low Drain Watch	6.8	2.60	1.55	28, 30
SR521SW	379	Silver Oxide	Low Drain Watch	5.8	2.15	1.55	14, 16
SR927SW	395	Silver Oxide	Low Drain Watch	9.5	2.73	1.55	55, 57
CR1216	CR1216	Lithium Manganese	General, Memory, Backup	12.5	1.60	3.0	25
CR2016	CR2016	Lithium Manganese	General, Memory, Backup	20.0	1.60	3.0	80
CR2025	CR2025	Lithium Manganese	General, Memory, Backup	20.0	2.50	3.0	150
CR2032	CR2032	Lithium Manganese	General, Memory, Backup	20.0	3.20	3.0	210
LR44	A76	Alkaline	General Use	11.6	5.40	1.5	60

CASE PRESS with NYLON DIES

The EURO TOOL case press offers the best inexpensive case closer available. Features include:

- Exclusive straightwall nylon dies will not scratch or mar crystals.
- Cast metal press to ensure strength.
- Assortment of fourteen dies (seven hollow and seven flat) to allow for all size watches. (Please note: The 18mm hollow die uses the 16mm flat die when closing smaller watch cases.)
- Snap-on system allows dies to snap on and off quickly.
- Face-down configuration means the repair person sees the case back being closed.
- Complete instructions included.

This is one of our most popular items and the closer we most recommend. Every bench should have one.

Stock #	Description	
A. CRY-905.00	Case Press w/ Nylon Dies	\$37.95
CRY-905.10	Replacement Nylon Die Set	\$19.95



SPECIAL DIE SET

This special die set made of high-impact nylon is excellent for revolving bezels on Rolex and other fine watches. Set includes four hollow dies (22, 26, 30, and 31mm) as well as two flat dies (24 and 32mm), which hold the watch while the revolving bezel is being inserted. You will find this set of dies to be an enhancement, and work excellent with the EURO TOOL CRY-905.00 or CRY-904.00 case press.

B. CRY-905.15		\$15.45
---------------	--	---------

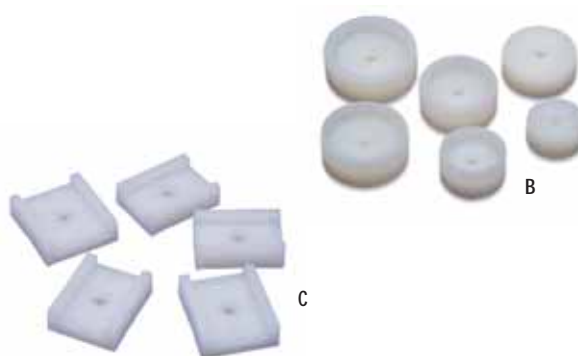

NYLON DIE SET – SQUARE/RECTANGULAR

We've had many requests for nylon dies for our CRY-905.00 or CRY-904.00 Case Closer to fit square or rectangular watches. Five sizes to a set, dies range from 15mm to 24mm. Offers you greater flexibility to close any snapback case without damage.

C. CRY-905.25		\$6.85
---------------	--	--------



EXTRA LARGE DIE SET

We have had many calls for larger snap-on nylon dies to fit our CRY-905.00. This set is designed for larger oversized watches that are very popular, and most have snap-on case backs. There are a total of six pieces, three flat on both sides, 35, 40 and 45mm, and three double sided concave that are 40/42.5, 45/47.5 and 50/52.5mm concave.

D. CRY-905.20		\$15.45
---------------	--	---------



“LITTLE DAVID” CASE CLOSER

Who said “bigger is better?” Our Little David case closer handles the toughest snap-on case backs. Cast metal press with six nylon non-scratch dies, it offers convenience and functionality in a compact unit weighing only 1 lb. and standing 3-1/2" high.

E. CRY-904.00		\$10.95
---------------	--	---------





Use a soft cloth such as a small selyvt for added protection when using metal case presses. Cloths shown on pages 173–174.

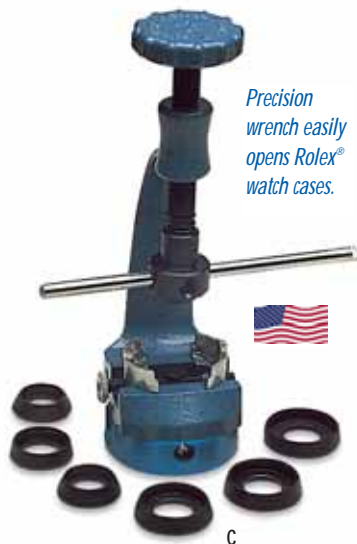

Precision wrench easily opens Rolex® watch cases.

Openall with non-scratch holder shown with optional base (CWR-650.10).



COMBO CLOSER

This combination case closer/crystal press beats anything in its price range and beyond. It features:

- 14 reversible, turned aluminum dies with 28 sizes, smoothed to a high polish so they will not scratch.
- Dies screw onto the upper and lower part so that they can be inverted for case closing or crystal fitting.
- Cast metal body with angled leverage arm for proper closure.

Don't destroy watch cases or case backs by using the wrong tool. Our Combo Closer will give you years of satisfaction and service. Another EURO TOOL best buy.

Stock #	Description	
A. CRY-908.00	Combo Closer	\$49.95
CRY-908.10	Replacement Die Set	\$28.45

CRYSTAL PRESS/CASE CLOSER COMBINATION

This tool offers the best of both worlds – price and quality. Made of metal with multiple dies, this crystal press/case closer is the perfect tool for snap-back cases. You'll have enough leverage to properly close the back, and enough control to make the proper fit. The hollow dies allow fitting without damaging the crystal or bezel. It is recommended to put a soft cloth between the bezel and die so that no marring can occur.

Stock #	Description	
B. CRY-910.00	Crystal Press / Case Closer Combination	\$39.95
CRY-910.10	28 pc Aluminum Replacement Die Set	\$19.96

L-G "OPENALL" WATERPROOF CASE WRENCH

Designed to open Rolex Oyster® cases. The six tempered rings will fit every existing size and because they are precision-made to interlock, they will not slip. The sturdy cast frame fits into your bench vise and the small bar gives you the torque you need for stubborn case backs. An optional base is available. The built in adjustable case holder fits all size watches. The L-G "Openall" can also be used in conjunction with the L-G wrench. Ring sizes are 18.5, 20.2, 22.5, 26.5, 28.3, 29.5mm.

Stock #	Description	
CWR-650.00	Openall Case Wrench	\$79.95
C. CWR-655.00	Openall Case Wrench w/ Base	\$92.95

Replacement Pieces

Stock #	Description	
CWR-650.01	Replacement Ring - 18.5mm	\$6.95
CWR-650.02	Replacement Ring - 20.2mm	\$6.95
CWR-650.03	Replacement Ring - 22.5mm	\$6.95
CWR-650.04	Replacement Ring - 26.5mm	\$6.95
CWR-650.05	Replacement Ring - 28.3mm	\$6.95
CWR-650.06	Replacement Ring - 29.5mm	\$6.95
CWR-650.07	Center Pin	\$3.20
CWR-650.08	Movement Holder	\$13.75
CWR-650.10	Base Only	\$13.95

L-G "OPENALL" CASE WRENCH with NON-SCRATCH HOLDER

Our very best Rolex case opener, but now offered with a case holder featuring nylon covered pins, which makes it unnecessary to use a cloth between the opener and the precious watch case. This adjustable case holder simply slips into the groove in the base of the opener – it's fast and convenient. Case holder is made of aluminum and the watch may be inserted into the holder, then put into the wrench to be removed. The case holder is our CWR-177.00 and may be purchased to retrofit your original CWR-650.00.

Stock #	Description	
D. CWR-656.00	Openall Case Wrench with Holder	\$77.95
CWR-177.00	Holder Only	\$6.95
CWR-650.10	Base Only	\$13.95



Use with our L-G Openall to open virtually any case – page 224

EXCLUSIVE

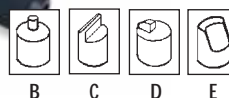

L-G MASTER CASE OPENER

Opens all sizes and shapes of waterproof cases. Comes with four sets of pins for case backs with notches, holes, knurled or polygon. Because of the L-G patented closing system, backs can be unscrewed without being scratched. Pins and accessories also available. 5 1/2" in length.

Stock #	Description	
A. CWR-600.00	Master Case Opener	\$49.95

Spare Pins and Replacement Parts

Stock #	Description	
B. CWR-600.01	Cover with Holes	\$2.75
C. CWR-600.02	Polygon Cover	\$2.75
D. CWR-600.03	Multinotch	\$2.75
E. CWR-600.04	Knurled Type	\$2.75
CWR-600.07	Center Shaft	\$2.60
CWR-600.09	Thumb Screw	\$5.00
CWR-600.10	12 pc Spare Pin Set	\$9.95



WATERPROOF CASE WRENCH

Modeled after the famous JAXA, but less expensive, this case wrench meets the highest standards at a moderate price. Packed in a hardwood box. Sets of spare pins also sold separately. 5 1/2" length.

Stock #	Description	
F. CWR-770.00	Waterproof Case Wrench	\$16.95

Spare Pins

Stock #	Description	
CWR-770.01	Round – Set of 3	\$1.04
CWR-770.02	Flat – Set of 3	\$1.04
CWR-770.03	Square – Set of 3	\$1.04
CWR-770.04	Curved – Set of 3	\$1.04
CWR-770.05	12 pc Spare Pin Set (3 each of 4 types)	\$4.25



WATERPROOF CASE WRENCH

Case wrench modeled after the famous JAXA is available from EURO TOOL. This version offers exceptional value while still meeting quality standards. Comes with one complete set of pins and packaged in a cardboard box. 5 1/2" length.

Stock #	Description	
G. CWR-771.00	Waterproof Case Wrench	\$14.60

ROLEX-STYLE CASE OPENER

For opening oyster-shaped cases made by Rolex. Includes the wrench and six dies in the appropriate sizes: 18.5, 20.2, 22.5, 26.5, 28.3 and 29.5mm.

Stock #	Description	
H. CWR-780.00	Case Opener w/ Dies	\$45.95
CWR-780.10	Replacement Set of Dies	\$26.95



"V" SHAPE CASE OPENER

Remover for screw type case backs. This model is popular with many watchmakers, offering a large surface for grasping and adjustable claws.

Stock #		
I. CWR-580.00		\$29.95



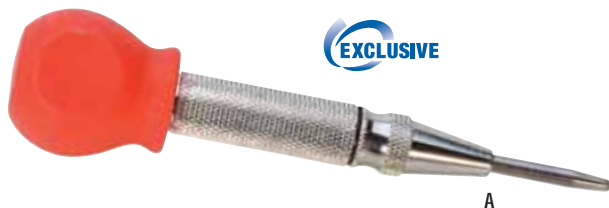

EXCLUSIVE

A



B



C



D



E



F



G



H



I

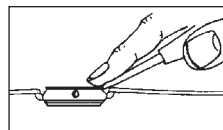

SNAPPY CASE OPENER

Another EURO TOOL exclusive designed to make opening watch cases easier. Just position the point between the case back and the case, and slowly push.

The blade "pops" under the back, making it easy to lift

off. There is nothing like this on the market today! Complete instructions included.

Stock #	
A. KNF-168.00	\$11.50

GUCCI CASE OPENER

Case opener for Gucci is made specifically to pry open the many Gucci watches with notched case backs. Tool is case hardened steel - no more broken tweezers or damaged cases.

Stock #	
B. CWR-568.00	\$17.95

SCREW BACK CASE OPENERS

Easy-to-use opener made for screw-back watch cases. Plenty of leverage for stubborn case backs and ensures a tight, non-slip grip. Easily adjustable lugs for case backs with notches. Made with a heavy, solid metal 4 1/2" handle.

Stock #	Description	
C. CWR-573.00	Round Pins	\$9.95
D. CWR-574.00	Square Pins	\$9.95

SNAP-BACK CASE OPENER

This special cylindrical, spoon-shaped tool opens practically all types of cases with press-fit backs, even the most tightly closed. Made in Switzerland.

Stock #	Length	
E. KNF-155.00	5 1/4"	\$22.00

SWATCH® BATTERY LID OPENER

Ever try to retrieve a battery from a Swatch® watch with a coin? Here's a much easier answer. Our new opener has just the right tip to fit precisely into the battery cover on Swatch® watches. Saves time and fingers when trying to open those stubborn compartments. Made of steel with a hardwood handle.

Stock #	Length	
F. KNF-164.00	4"	\$6.45

POCKET CASE WRENCH

Our quality pocket case wrench has tempered pins for easy use on waterproof cases. Its compact size makes it very convenient.

Stock #	Description	
G. CWR-777.00	2 5/8" x 1 1/8"	\$6.70

SUCTION-TYPE CASE OPENER

Great for lifting the case back off of screw-back and waterproof watches after it has been loosened. The rubber tip will not scratch cases or crystals. Twisting motion applies suction to the case to open it.

Stock #	Length	
H. CWR-778.00	4 1/4"	\$3.25

ANTI-STATIC MAT

Our anti-static mat helps assure a clean work surface and the light green color is easy on the eyes. Scientifically proven to reflect the right amount of daylight, repair people will experience less eye fatigue than with other colors. High density, lies flat, doesn't slide or attract lint. Measures 9.5" x 14" (24 x 50cm).

Stock #	
I. MAT-695.00	\$9.85

CASE KNIFE

Configured to make opening certain cases easier, this opener is popular among many watchmakers. Simply place the blade under the case back and twist.

Stock #	Length	
A. KNF-165.00	3"	\$4.25

SEIKO® STYLE CASE OPENER

Much like our KNF-165.00 but with a more conventional handle. This knife makes opening snap-back cases quick and easy. Blade is tempered and properly beveled. Simply insert between case back and case and twist.

Stock #	Length	
B. KNF-167.00	3"	\$5.45

SNAP-BACK CASE KNIVES

Special Swiss case knife is 4" long with hard plastic handle and tempered blade. Fixed blade does not fold into handle. The economy or deluxe model is perfect to include as part of a battery change kit or to use for other applications where price is the issue.

Stock #	Description	
C. KNF-156.00	Swiss Model	\$20.95
D. KNF-156.50	Deluxe Model	\$7.95
E. KNF-160.00	Economy Model	\$4.95

CASE OPENING KNIFE

This universally popular shape gives the watchmaker the small handle necessary to properly grip when prying open snap-on case backs. Hardwood handle and a precisely beveled, tempered steel blade makes case opening easier.

Stock #	Length	
F. KNF-975.00	4½" (115mm)	\$4.65

CASE KNIFE

This sturdy German-made case knife features a comfortable cushion grip PVC handle which gives the user excellent leverage. The blade has a single bevel edge for removing those difficult case backs. Material is well-tempered tool steel.

Stock #	Length	
G. KNF-158.00	4½" (115mm)	\$15.95

BENCH KNIFE

The traditional bench knife works well for a wide variety of uses, especially scraping and prying. The sturdy stainless steel blade mounted in a hardwood handle shaped to fit the hand, stands up well to rugged utility use.

Stock #	Length	
H. KNF-967.00	6" (150mm)	\$3.80

BENCH KNIFE

Deluxe bench knife features riveted handle and tempered blade. Excellent for opening watch cases.

Stock #	Length	
I. KNF-970.00	5¼" (135mm)	\$3.35

SWISS POCKET KNIFE

Made in Switzerland by the maker of the famous Swiss Army Knife, it is excellent for all-purpose use. Closed length is 3½", and the knife features stainless steel blades and anodized handle. Short blade is made specifically for opening watch cases. Be careful, the longer cutting blade comes extremely sharp!

Stock #		
J. KNF-883.00		\$25.95



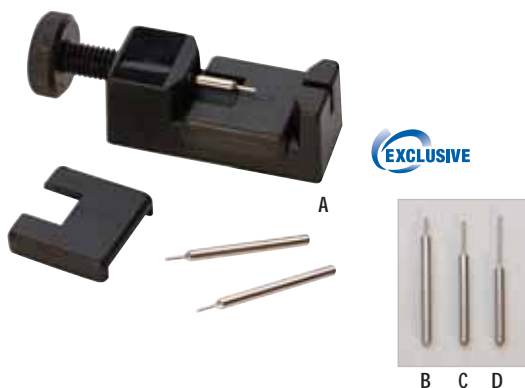

EXCLUSIVE

**LINK PIN REMOVER**

Essential for removing pins from metal link bands. Made of Keltec II, glass-filled nylon, this unit includes two extra spacers to accommodate all bracelet sizes and two extra push pins. The pusher pin is hardened tool steel. We guarantee years of satisfaction with this tool, which will not scratch or mar gold or silver.

Replacement pusher pins available in three lengths with an overall length of 31mm.

Stock #	Description	
A. HOL-118.00	Link Pin Remover with Extra Pins	\$15.15
B. HOL-118.01	Standard Replacement Pusher Pin (4mm tip)	\$2.55
C. HOL-118.01M	Medium Replacement Pusher Pin (7.5mm tip)	\$2.55
D. HOL-118.01L	Long Replacement Tip (12mm tip)	\$2.55

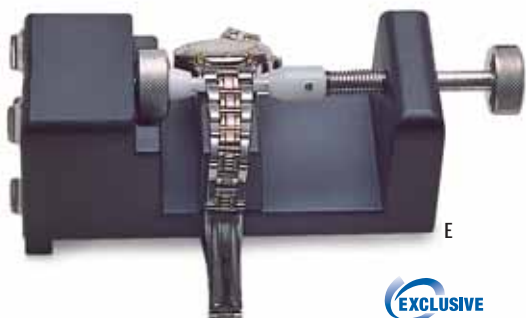

EXCLUSIVE

GUCCI® SCREW REMOVING TOOL

Swiss-made Gucci Screw Removing Tool is perfect for removing bracelet screws from Gucci and other high fashion watches. Blades are recessed in high-impact nylon, so that they cannot scratch. The body of this unit is made of Keltec II, glass-filled nylon and comes with two extra blades. You will never have to struggle again trying to remove Gucci screws. Measures 5 1/2" x 2" x 2 1/4".

Stock #	Description	
E. HOL-119.00	Gucci Screw Removing Tool	\$29.65
HOL-119.01	Spare Blade	\$3.30

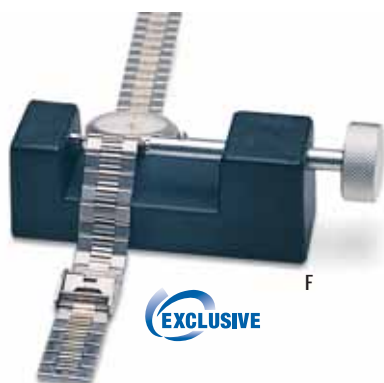

EXCLUSIVE

WATCH BRACELET SCREW REMOVER

Our Swiss-made Watch Bracelet Screw Remover is the only way to go when removing double-ended screws. Made of nearly unbreakable, high-impact glass-filled nylon, this tool features one fixed screwdriver blade and one turnable blade. Both blades are held fast and perfectly aligned to make removing stubborn screws easy. Blades are tempered steel and easily replaceable should they ever break.

Stock #	Description	
F. HOL-120.00	Bracelet Screw Remover	\$18.50
HOL-120.01	0.80mm Spare Blade	\$2.40
HOL-120.02	1.00mm Spare Blade	\$2.40

**SCREW REMOVING TOOL**

Try to remove a double-ended screw from a watch bracelet sometime. It can be an exercise in frustration, but if you use the new screw removing tool, the job becomes easy. Three Swiss-made blades (1.0, 1.4, 2.5mm in diameter) are friction fitted into a solid aluminum block. Just fit the bottom screw slot over the right blade and easily unscrew from the top. Makes life simple and assures that the bracelet will not be damaged, if used properly.

Stock #	Size	
G. SCR-896.00	1 1/2" x 1 3/16" x 1 1/16"	\$9.95

**MULTI-PURPOSE LINK AND SPRING BAR TOOL**

Multi-tool for removing and replacing friction fitted bracelet pins, bracelet screws and Gucci type bracelet screws. Securely holds bracelets in exact alignment to assure that the watch or bracelet will not be damaged. Pins and screwdriver blades are tempered tool steel. Frame is solid steel except for the non-scratch plastic bracelet holder, which fits bracelets of all sizes. Includes pin sizes 0.60, 0.80, 1.00mm and blade sizes 1.5mm and 2.5mm.

Stock #	Description	
H. SBT-290.00	Multi-Purpose Link and Spring Bar Tool	\$33.05
SBT-290.06	Set of 6 Replacement Pins	\$4.95

DELUXE PIN PUSHER

Handy for pushing stubborn pins from watch bracelets when changing the links for sizing. Our pin pusher features the best metal of any pin pusher on the market with hardened tool steel and an American-made hardwood handle. In fact, the tip is slightly flat to prevent slipping, and the handle is shaped so that it may be held like a pen. This allows the user greater control.

Stock #	Length	
A. PSH-230.00	4 3/4"	\$4.20



PIN REMOVING TOOL

Snap those stubborn pins out in a hurry with this clever device. Very similar to our Snappy case opener, it is spring loaded, so you simply put the watch bracelet onto one of our bracelet holders featured on page 199 and push down until you hear the "snap." Remove the pin with pliers if necessary once the other end is exposed. Unit is supplied with two springs so that the user can select the tension desired.

Stock #	Description	
B. PSH-225.00	Pin Removing Tool	\$12.95
PSH-225.01	Replacement Pins - pk/2	\$2.45



PIN PUSHER

Comfortable hardwood handle for pushing pins from watch bracelets. Tip is steel tapered to a fine point. Length 6".

Stock #	Length	
C. PSH-235.00	6"	\$1.95



PIN REMOVING TOOL

This upgraded pin removing tool is attractive aluminum with three long pins: .70, .80 and .90mm and three short pins: .70, .80 and .90mm diameter. Pins are polished tempered stainless steel. User can tap the top of this pin remover with a small hammer for those stubborn pins.

Stock #	Description	Length	
D. PSH-125.00	Pin Removing Tool	4 1/2"	\$5.95
PSH-125.01	Replacement Pin Set - 6pc		\$2.95

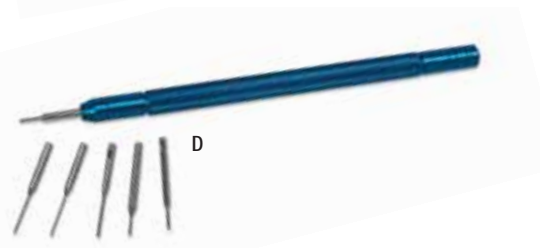

PIN REMOVING SPRING BAR TOOL SET

This set includes one hard plastic band holder, two pin removers, three spare pins 0.80mm diameter and three spare pins size 1.00mm diameter. Pin removers are threaded to easily change broken or damaged pins.

Stock #		
E. PSH-120.00		\$14.85



PIN REMOVING KIT

Our kit is the most practical one made for removing friction pins from watch bracelets. The grooved block holds the bracelet steady so the repairman can hold the punch and tap it lightly with the small hammer provided. Pins are tempered steel 1.00mm and 0.80mm and are replaceable. They are secured by set screws. Kit (PSH-100.00) includes: hammer, two punches (1.00mm and 0.80mm), two extra pin tips, and bracelet holder. All components also available individually, plus additional smaller tip (0.70mm).

Stock #	Description	
F. PSH-100.00	Pin Removing Kit	\$20.95
HAM-430.02	Small Ball Pein Hammer	\$4.25
HOL-113.00	Wood Bracelet Holder	\$7.05
PSH-200.70	0.70mm Pin Removing Punch	\$4.95
G. PSH-200.80	0.80mm Pin Removing Punch	\$4.95
PSH-201.00	1.00mm Pin Removing Punch	\$4.95
PSH-200.07	Pin Tip - 0.70mm	\$0.86
PSH-200.08	Pin Tip - 0.80mm	\$0.86
PSH-200.10	Pin Tip - 1.00mm	\$0.86
PSH-150.00	Replacement Pin Removers - Set of 2 (0.80mm, 1.00mm)	\$10.45
PSH-200.00	Replacement Pin Removers - Set of 3 (0.70mm, 0.80mm, 1.00mm)	\$15.24



Replacement pin punches and tips are available individually or in sets.

Kit includes: wood bracelet holder, small hammer, one .80 and 1.00mm pin removing punch and 1 each extra .80 and 1.00mm tip.



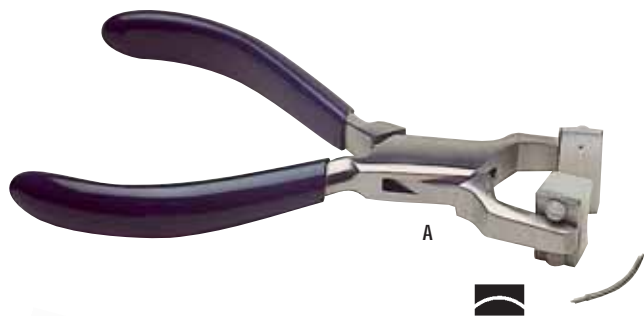

A



B



C



D

E

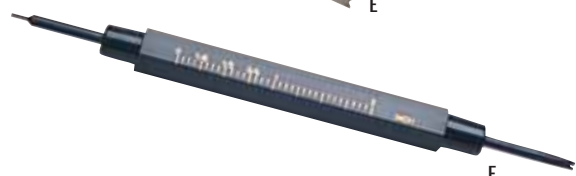

F



G

H



I

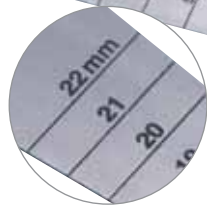

One side in
millimeters, the
other in inches!



J

SPRING BAR BENDING PLIER

This unique and practical spring bar bending plier delicately bends spring bars of any size to the proper shape. Jaws are made of high impact nylon and grooved to hold the spring bar in place while bending. Stainless steel box-joint construction.

Stock #	Description	Length	
A. PLR-845.00	Spring Bar Bending Plier	5" (125mm)	\$14.95
PLR-845.05	Replacement Jaws (pair)		\$4.15

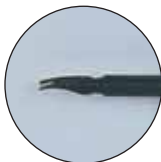

JAPANESE SPRING BAR TOOL

This popular model is called "Japanese" because it originated in Japan and features a special shaped fork tip. Many people prefer this shape for getting under straps and bands. Anodized aluminum body with hardened tool steel double-ended tip.

Stock #	Description	Length	
B. SBT-205.00	Japanese Spring Bar Tool	5 1/4" (135mm)	\$7.95
SBT-205.01	Repl. Tip, Double-Ended		\$2.35

METAL SPRING BAR TOOL

Our spring bar tool is entirely metal and made to last for years. Tips are stronger than conventional spring bar tools but have the same thread for interchangeability. Many customers have asked for a deluxe version; we believe this one is the nicest we've seen to date.

Stock #	Description	Length	
C. SBT-200.00	Metal Spring Bar Tool	5 1/8"	\$7.49
D. SBT-200.05	Replacement Tip – Straight		\$1.30
E. SBT-200.10	Replacement Tip – Forked		\$1.30

SPRING BAR TOOL

To change spring bars, use this tool with tempered tips which are interchangeable with the famous Swiss model, but at less cost. The tool features a millimeter scale on the handle.

Stock #	Description	Length	
F. SBT-100.00	Spring Bar Tool	5"	\$5.35
G. SBT-100.05	Replacement Tip – Round		\$0.95
H. SBT-100.10	Replacement Tip – Forked		\$0.95

SPRING BAR GAUGE

Our new lug gauge gives you the exact measurement you need to determine the distance between watch lugs for spring bars, bands or bracelets. Made of stainless steel with permanently embossed lines and numbers, one side in millimeters, the other in inches.

Stock #		
I. GAU-186.00		\$3.95

CROWN WINDER

Crown winding tool for easy winding of mechanical watches. Spring-loaded, all-metal construction for 5–7mm crowns. Also works well as a precision nut driver to securely hold small size nuts when installing. Easy to use and saves the fingers. Made in France.

Stock #	Length	
J. PIN-215.00	3"	\$21.95

PRICES ARE SUBJECT TO CHANGE WITHOUT NOTICE.

Please note prices are subject to change without notice due to fluctuations in foreign exchange rates, raw material costs, duties and other factors beyond our control.

Four moveable pins accommodating large and small items makes this holder great for repairs.



UNIVERSAL WORK HOLDER

The four movable pins accommodate large and small items during repair. Set of four replacement pins also available.

Stock #	Description	
A. HOL-166.00	Holder	\$18.95
HOL-166.04	Set of Four Replacement Pins	\$2.95

MOVEMENT HOLDER

A must for every watchmaker, this movement holder clamps onto the edge of your bench. The holder is made of metal and will hold any size movement.

Stock #	Description	
B. CWR-180.00	Movement Holder	\$6.55

Clamps onto the edge of your bench and holds any size movement.



WOODEN CASE HOLDER

Wood will not scratch a watch case. Plus, this holder is stable and larger than most, accommodating any size. Measures 3" x 2 11/16" x 1 1/2".

Stock #	Description	
C. CWR-167.00	Wooden Case Holder	\$5.05



ADJUSTABLE SLIDE MOVEMENT HOLDER

Easy-to-use universal holding tool is great for securely holding watch movements while working. Spring-operated with plastic posts which will not mar or scratch your piece. Maximum capacity 1 3/8" (36mm).

Stock #		
D. CWR-170.00		\$6.95



MOVEMENT HOLDER with FOUR PINS

Check the price and you'll agree that this is a great value. Our holder is very well made and comparable to holders at twice the price. Set of four replacement pins also available.

Stock #	Description	
E. CWR-175.00	Holder	\$6.64
F. CWR-175.04	Set of 4 Replacement Pins	\$2.25

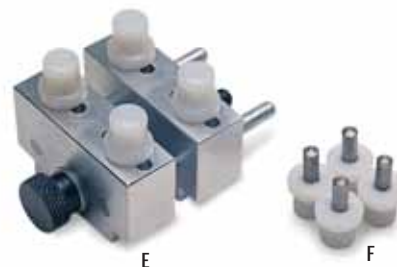

WOOD BRACELET HOLDER

The EURO TOOL bracelet holder is made from the perfect medium because wood will not scratch precious metals. Holding a watch bracelet while removing pins or screws is difficult, but with this tool, it becomes routine. Slits of various widths allow the user to handle any thickness of bracelet, and a hole in the middle of the holder allows one to push out bracelet pins. This is a must for every bench.

Stock #	Size	
G. HOL-113.00	2 5/16" x 2 5/16" x 1 1/8"	\$7.05

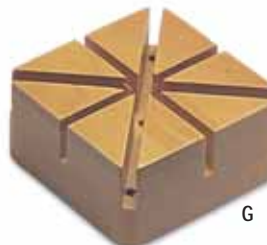

PLASTIC BRACELET HOLDER

Now available in a high-impact, plastic gray color with more slots, including one which is extra wide for larger bracelets. Allows the repairer to tap out pins or take out and replace screws easily. Take the struggle out of band sizing.

Stock #	Size	
H. HOL-114.00	2" x 2 1/2" x 1"	\$8.15



BRACELET HOLDER – SWISS MADE

Another must for any bench. Our plastic bracelet holder allows you to securely hold bracelets for removing screws or pins. Four different grooves of varying widths assure the perfect hold for every bracelet. Made in Switzerland.

Stock #	Size	
I. HOL-115.00	2" x 2" x 1 1/8"	\$17.95





A

CRYSTAL CEMENT

Precision applicator allows maximum control with this jeweler's cement. Traditionally used for plastic or glass watch crystals but also great for bead stringing. Non-brittle, dries clear.

Stock #	Description	
A. GLU-105.00	Net wt. 1/3 oz.	\$5.00



B

UV GLUE with TIP

Clear crystal adhesive that cures under ultraviolet light or direct sunlight. Tube contains .07 fluid ounces. Special tip for precise application makes putting glue on uniformly an easy job.

Stock #	Description	
B. GLU-112.00	UV Glue	\$7.95
GLU-112.01	Extra Tip	\$1.20
C. GLU-113.00	UV Glue - Light Formula	\$8.25



C



D

CRYSTAL REMOVER and INSERTER

Here's a safe and easy way to remove unbreakable watch crystals without dismantling the watch. The jaws open from 12 to 37mm and are designed for both ladies' and gents' watches. Supplied complete with baseplate.

Stock #		
D. CRY-179.00		\$15.35



E

CRYSTAL BRIGHT

The perfect compound for removing scratches from plastic crystals. This is a money saver and extremely easy to use by charging your buffing wheel with a small amount of compound. Crystal Bright may also be used with a selvyt cloth if scratches and abrasions are minor. Using Crystal Bright in a gentle buffing motion can make old crystals look brand new.

Stock #	Description	
E. POL-603.00	3 oz.	\$3.95

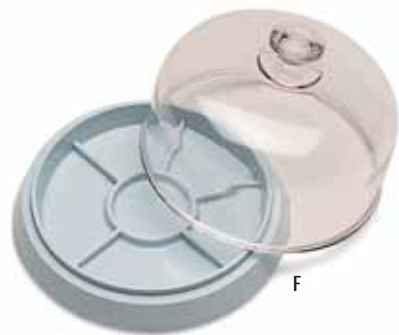

F

DUST COVER with TRAY

A handy compartmentalized tray for holding small parts. Comes with a clear plastic dome to keep dust out.

Stock #		
F. TRA-450.00		\$3.85



G

DUST BLOWERS

Swiss-made rubber model has a plastic sheathed nozzle. Measures 5" x 2" and weighs 2 oz. Small blower measures 3 3/4" x 1 3/4".

Stock #	Description	Size	
G. BLO-666.00	Swiss-Made Blower	5" x 2"	\$15.45
BLO-666.50	Dust Blower - Economy	5" x 2"	\$4.45
H. BLO-665.00	Small Dust Blower	3 3/4" x 1 3/4"	\$3.95



H

DELUXE WATCH PAPER

These handy squares of tissue are excellent for wrapping small parts for shipping, storing or handling. Economical, each box contains a quantity of 1000 4" x 4" sheets of high quality tissue which keeps parts from rubbing and scratching.

Stock #	Qty.	
I. DIA-305.00	1000/bx	\$4.75



I

BROACH SET

This assortment of six popular sizes with plastic handles contains sizes 46 through 72 (according to English Stubs gauge). Our broaches are five-sided and have a regular taper and perfect finish. Contains the following sizes: 72 (0.60mm), 66 (0.80mm), 60 (1.00mm), 54 (1.40mm), 52 (1.60mm), and 46 (2.00mm). Made in Germany.

Stock #	
A. BRO-174.00	\$11.75

EXTRA FINE BROACH SET

Features a miniature pin vise and 12 tiny broaches made of high carbon cutting steel. Broaches are five-sided for enlarging holes and range from .05 - .55mm. Made in Germany.

Stock #	
B. BRO-140.00	\$21.95

SILICONE GREASE

High grade silicone grease is perfect for waterproof gaskets. Lubricated in silicone grease, they will last much longer and are much less likely to leak. It also insures that the gasket will not be damaged when the back of the watch is snapped or screwed on. This small amount lasts a very long time.

Stock #	
C. WAT-750.00	\$3.90

SILICONE SEALANT BOX

Now handier than ever, Silicone Sealant for watch gaskets available in an easy-to-use box! Sponges permanently attached inside are impregnated with silicone grease so there is less waste and never grease where you don't need it. Silicone grease is the best gasket sealant available, because it is water repellent and keeps gaskets lubricated and flexible for a lighter, longer seal.

Stock #	
D. WAT-755.00	\$3.95

POCKET OILER

This is the best oiler we have ever seen. Just squeeze and you'll get the right amount of lightweight oil with rust inhibitors. Plastic spout extension available which enables you to get to those hard-to-reach places.

Stock #	Description	
E. OIL-355.00	Oiler	\$2.45
OIL-358.99	Plastic Spout Extension - 8"	\$0.50

POCKET WATCH KEYS

Set of 14 sizes 00 to 12. Steel shanks with traditional brass for years of life.

Stock #	
F. CLK-100.14	\$9.20

MINI TAP and DIE SETS

Screwplate with taps for threading wire or re-threading stripped threads on screws. Wood storage box keeps all taps conveniently together with screwplate.

Stock #	Description	
G. TAP-135.00	14 pc Tap and Die Set, 0.7 - 2.0mm	\$21.90
H. TAP-135.50	14 pc Tap and Die Set in Wood Box, .07 - 2mm	\$25.95
I. TAP-138.00	8 pc Tap and Die Set in Wood Box, .06 - 2mm	\$25.95



A



B



C



D



E



F



H



I

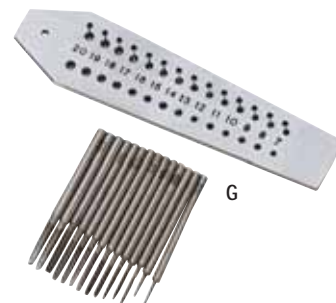

G



B

This set is great for those on the move and can be stored when not in use.

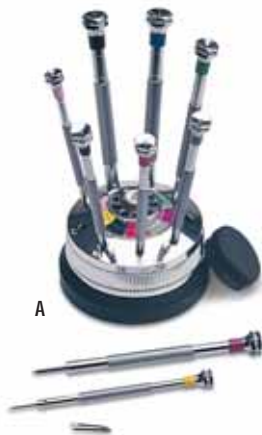

A



C



D



E

Blades sold separately in packs of three (see page 192).



F



G

SET-SCREW SCREWDRIVER SET IN ROTATING STAND

This premium set of nine color-coded set-screw screwdrivers includes 19 spare blades and two extra set-screws. Blades are held tightly with set-screws. Screwdrivers range from 0.60 – 3.00mm. The stand gives easy access for busy repairmen. Made in Europe.

Stock #	Description	
A. SCR-980.00	Set of 9 in Rotating Stand	\$53.80
SCR-990.00	Replacement Blade Set (3 each of 9 sizes)	\$13.00

Individual Screwdrivers

Stock #	Size	Color		Stock #	Size	Color	
SCR-980.60	0.60mm	Pink	\$4.45	SCR-981.60	1.60mm	Purple	\$4.45
SCR-980.80	0.80mm	Yellow	\$4.45	SCR-982.00	2.00mm	Green	\$4.45
SCR-981.00	1.00mm	Black	\$4.45	SCR-982.50	2.50mm	Blue	\$4.45
SCR-981.20	1.20mm	Red	\$4.45	SCR-983.00	3.00mm	Brown	\$4.45
SCR-981.40	1.40mm	Gray	\$4.45				

ZSD18978V	Replacement Screw for Set-Screw Screwdrivers	\$0.47
-----------	--	--------

SET-SCREW SCREWDRIVER SET IN WOODEN BOX

The same high-quality screwdrivers included in the SCR-980.00. The screwdrivers and spare blades come complete in a beautifully finished hardwood box.

Stock #	Description	
B. SCR-989.00	Set of 9 in Wooden Box	\$58.95
SCR-990.00	Replacement Blade Set (3 each of 9 sizes)	\$13.00

DELUXE FIXED-BLADE SCREWDRIVERS

European fixed-blade screwdrivers with color-coded bands to indicate sizes. Precisely ground, tempered blades with nicked handles and hex heads. Excellent quality matched with economy makes these a winner.

Stock #	Description	
C. SCR-260.00	Set of 6 in Pouch (0.80, 1.00, 1.20, 1.40, 1.60, 2.00mm)	\$14.55

Individual Screwdrivers

Stock #	Size	Color		Stock #	Size	Color	
SCR-260.80	0.80mm	Yellow	\$2.04	SCR-261.40	1.40mm	Gray	\$2.04
SCR-261.00	1.00mm	Black	\$2.04	SCR-261.60	1.60mm	Violet	\$2.37
SCR-261.20	1.20mm	Red	\$2.04	SCR-262.00	2.00mm	Green	\$2.37

REVERSIBLE-BLADE SCREWDRIVER SETS

A very popular set of screwdrivers that features color-coded hex heads and reversible blades ranging from 1.30mm – 0.60mm. Blades are tempered and finely ground to exact specifications.

Stock #	Description	
D. SCR-730.02	Set of 7 Screwdrivers in Box (sizes #3 - #9)	\$28.05
SCR-730.01	Set of 7 Screwdrivers in Pouch (sizes #3 - #9)	\$27.42
SCR-740.01	Replacement Blade Set for SCR-730.01 and SCR-730.02 (21 pc Set, 3 each sizes: #3 - #9)	\$10.25
E. SCR-373.00	Set of 6 in Wooden Stand (sizes #4 - #9)	\$32.00
SCR-374.00	Replacement Blade Set (6 pc Set, 1 each size #4 - #9)	\$3.15

WATCH BAND SHEAR

The best shear made to cut metal and/or mesh watch bands. It features a cylindrical tempered steel blade and 90° cutting head. The bands are cut at right angles and never fray or part. Holes in each corner of the base allow user to bolt the unit to a bench for more stability.

Stock #	Weight	
F. SHR-200.00	Italian Band Shear	\$124.95
SHR-205.00	Economy Band Shear	\$79.95

DEMAGNETIZER/MAGNETIZER

Perfect for demagnetizing tweezers, screwdrivers and other small tools and parts. Will also magnetize tools such as screwdrivers if you desire. This magnetizer has a high power to weight ratio and is housed in non-breakable plastic. It is a 120V AC intermittent use type, which features a 1 1/2" by 3" opening and is 300 watts. A necessary addition to any workbench.

Stock #		
G. DEM-345.00		\$62.95

SYNTHETIC, NON-CONDUCTIVE TWEEZER

This synthetic non-conductive tweezer is ideal for changing watch batteries.

Stock #	Length	
A. TWZ-799.00	5"	\$1.10

SCREW-HOLDING TWEEZER

Ideal for battery clamps and screws, the V-shaped notch makes it possible to hold the smallest screws for assembly or attaching battery straps in watches.

Stock #	Length	
B. TWZ-808.00	4 ³ / ₈ "	\$7.25

DUMONT TITANIUM TWEEZERS – 100% NON-MAGNETIC

Dumont combines its high standards of excellence with the outstanding features of titanium to produce an unequalled line of titanium tweezers. Titanium is 40% lighter than steel and 60% stronger, giving these tweezers a light touch and strong fine points.

Stock #	Style	Length	
C. TWZ-120.10	# 1	4 ³ / ₄ " (120mm)	\$27.95
D. TWZ-120.16	# 3	4 ³ / ₄ " (120mm)	\$27.95
E. TWZ-120.40	# AA	4 ⁷ / ₈ " (125mm)	\$27.95



IDEAL-TEK TWEEZERS

Introducing Ideal-tek; a fixture for over 40 years in the manufacturing of high quality precision tweezers the jewelry and watch making industries have come to expect from a Swiss manufacturer. EURO TOOL is proud to be the exclusive distributor of these fine instruments in North America. Ideal-tek products offer precision balance, alignment, symmetry along with smooth surfaces to provide the user an ideal experience when using these fine instruments. Optimum quality assured through ISO certification. Available in stainless steel which is used where strength and hardness are of primary concern or stainless steel anti-magnetic used where corrosion resistance and toughness are required.

IDEAL-TEK STAINLESS STEEL TWEEZERS

Stock #	Style	Description	Length	
TWZ-311.04	00	Inox (Stainless Steel)	4 ³ / ₄ " (120mm)	\$18.23
TWZ-311.10	1	Inox (Stainless Steel)	4 ³ / ₄ " (120mm)	\$18.45
TWZ-311.16	3	Inox (Stainless Steel)	4 ³ / ₄ " (120mm)	\$18.00
TWZ-311.18	3C	Inox (Stainless Steel)	4 ³ / ₈ " (110mm)	\$18.00
TWZ-311.22	5	Inox (Stainless Steel)	4 ³ / ₈ " (110mm)	\$21.75
TWZ-311.28	7	Inox (Stainless Steel)	4 ¹ / ₂ " (115mm)	\$23.25

IDEAL-TEK STAINLESS STEEL ANTI-MAGNETIC TWEEZERS

Stock #	Style	Description	Length	
TWZ-312.04	00	Anti-Magnetic	4 ³ / ₄ " (120mm)	\$16.20
TWZ-312.10	#1	Anti-Magnetic	4 ³ / ₄ " (120mm)	\$15.95
TWZ-312.16	#3	Anti-Magnetic	4 ³ / ₄ " (120mm)	\$15.95
TWZ-312.18	#3C	Anti-Magnetic	4 ³ / ₈ " (110mm)	\$15.95
TWZ-312.22	#5	Anti-Magnetic	4 ³ / ₈ " (110mm)	\$19.25
TWZ-312.28	#7	Anti-Magnetic	4 ¹ / ₂ " (115mm)	\$20.80
TWZ-312.40	AA	Anti-Magnetic	5 ¹ / ₈ " (130mm)	\$11.85
TWZ-312.56	SS	Anti-Magnetic	5 ¹ / ₂ " (140mm)	\$15.95

See our Optivisor accessories
on page 116-117

- Comfort Headband
- LED Light Attachment

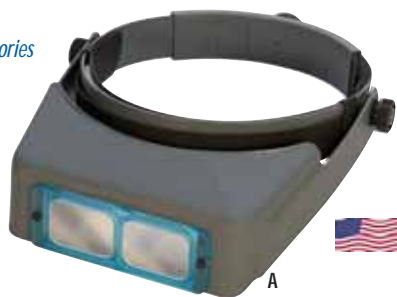

A. GENUINE OPTIVISORS®

Known worldwide as the best headband magnifier on the market today. Lenses are made of the highest quality optical glass. Six magnifications are available with interchangeable lenses. Headband is leather lined for years of comfort. High impact plastic visor. Special Optiloupe attachment also available for extra power.

Stock #	Description	Magnification	Focal Range	
ELP-502.00	Optivisor #2	1½ X	20"	\$39.95
ELP-503.00	Optivisor #3	1¾ X	14"	\$39.95
ELP-504.00	Optivisor #4	2 X	10"	\$39.95
ELP-505.00	Optivisor #5	2½ X	8"	\$39.95
ELP-507.00	Optivisor #7	2¾ X	6"	\$41.95
ELP-510.00	Optivisor #10	3½ X	4"	\$41.95
ELP-522.00	Replacement Lens #2	1½ X	20"	\$23.95
ELP-523.00	Replacement Lens #3	1¾ X	14"	\$23.95
ELP-524.00	Replacement Lens #4	2 X	10"	\$23.95
ELP-525.00	Replacement Lens #5	2½ X	8"	\$23.95
ELP-527.00	Replacement Lens #7	2¾ X	6"	\$25.60
ELP-530.00	Replacement Lens #10	3½ X	4"	\$25.60
ELP-500.01	Optiloupe Attachment (adds 2½ X magnification)			\$8.95

EASY EYES HEAD MAGNIFIER

Lightweight magnifier offers four magnifications in one. Flip down loupe, built in main lens and an inner auxiliary lens allow possible magnification ranging from 1.8X to 4.8X. Inner auxiliary lens flips up inside headband when not in use. Comfortable, adjustable Velcro strap.

Stock #		
B. ELP-550.40		\$8.95

VERSATILE HEADBAND MAGNIFIER

Our new headband magnifier with light and comfortable and easily adjustable headband offers the most versatility of any headband magnifier made. Four clearly marked lens plates (1.2x, 1.8x, 2.5x and 3.5x) that snap on and off easily. The center position swivel 2.2V/0.75A lamp gives pinpoint lighting in hard-to-see situations. Runs on two AAA batteries. This is the ultimate in lighted headband magnifiers. You're guaranteed to like it.

Stock #		
C. ELP-550.00		\$34.95

D. BAUSCH & LOMB® WATCHMAKER'S LOUPES

Single lens loupes made of optical glass. Their shape allows them to rest comfortably in the eye socket. This has become the standard style of loupe used in the watchmaking industry and is excellent for any application where magnification is needed while keeping both hands free.

Stock #	Focus	Power	
ELP-801.00	1"	10X	\$16.83
ELP-801.50	1½"	7X	\$14.28
ELP-802.00	2"	5X	\$14.28
ELP-802.50	2½"	4X	\$13.99

E. PLASTIC EYE LOUPES

Our loupes are high-quality, but inexpensive enough to make them attractive for production use.

Stock #	Focus	Power	
ELP-174.10	1"	10X	\$1.90
ELP-174.20	2"	5X	\$1.90
ELP-174.25	2½"	4X	\$1.70

F. ALUMINUM EYE LOUPES

High-quality, durable loupes are tough but lightweight. This pocket-size piece has distortion-free lenses and black on the inside of the aluminum housing to eliminate glare.

Stock #	Focus	Power	
ELP-205.10	1"	10X	\$1.90
ELP-205.20	2"	5X	\$1.70
ELP-205.25	2½"	4X	\$1.70

CLIP SPRING REMOVING PLIERS

An essential tool for adjusting the length of expandable watch bands. The flat jaw rests atop the link, and the pointed tip fits under the clip spring. By gently squeezing, the clip spring pops up and can be easily removed to allow for sizing.

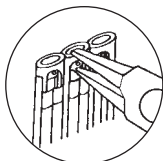

Stock #	Length	
A. PLR-136.01	5 1/2"	\$9.95

CLIP SPRING REMOVING PLIERS - GERMAN

Made in Germany, this plier is the best quality pin remover on the market. The round nose fits snugly into the recessed pin to snap it out cleanly.

Stock #		
B. PLR-136.05		\$17.60

HOLE-PUNCHING PLIERS

Our updated hole punch pliers are made of the finest steel for long life and ease of use. We've gone high tech with this model, bringing the cost down and the quality up. Unlike most hole punch pliers, this one offers a 1.5mm punch with precise clearance for a clean cut. Gentle return-springs and EURO GRIP handles for comfort.

Stock #	Length	
C. PLR-138.05	5 3/4"	\$10.95

HOLE-PUNCHING PLIERS

Punch 2mm holes in leather or plastic bands with this handy plier. Great for sizing bands.

Stock #	Length	
D. PLR-138.00	5 1/2"	\$10.85

BOW-CLOSING PLIERS with BRASS JAW

Pliers are perfect for rounding and closing small bows without marring the inside or outside surface. You will be amazed at the ease with which you can gently shape and round wire, ring blanks and shanks to the shape desired, all with a simple hand tool. Sturdy box-joint construction, stainless steel, with no-mar brass jaw.

Stock #	Description	Length	
E. PLR-731.00	German Model	5 1/2"	\$52.45
PLR-731.50	Economy Model	5 1/2"	\$19.95

WATCH STRAP NOTCHING PLIERS

Sometimes referred to as a "Gucci" plier, this cutter is for notching watch straps, eliminating excess inventory. Made of stainless steel, cuts notches 2mm wide.

Stock #	Length	
F. PLR-816.00	5"	\$12.30

LEATHER PUNCH PLIERS

This unique tool, made of stainless steel, features a hardened rotating wheel which allows the user to cut hole sizes from 0.80 to 2.0mm. Great for leather and other soft materials, these pliers are box-jointed with a return spring for ease of handling.



Stock #	Length	
G. PLR-139.00	6 1/4"	\$24.95

CASE-CLOSING PLIERS

One of our most popular items, the optical pliers work very well for closing snap-back cases where extra leverage is needed. Jaws are rubber-lined to eliminate scratching or breaking crystals.

Stock #	Length	
H. PLR-820.00	7 3/4"	\$15.95



For Gucci or Gucci-type bracelets.

Cuts notches up to 2mm wide.

Green Silver

SILVER WIRE

Green Silver? That's right! Green as in all our silver wire and sheet is from 100% reclaimed silver – none from mined sources. We feel good about that and you can too! All silver wire listed is dead soft and coiled.

STERLING SILVER .925 – ROUND

Stock #	Description	Qty.	Approx. Length / 1/2 ozt.	
MET-300.16	16 gauge	1/2 ozt	3.75 ft.	\$16.97
MET-300.18	18 gauge	1/2 ozt	6 ft.	\$16.97
MET-300.20	20 gauge	1/2 ozt	9.5 ft.	\$16.97
MET-300.22	22 gauge	1/2 ozt	15.5 ft.	\$16.97
MET-300.24	24 gauge	1/2 ozt	25 ft.	\$16.97

STERLING SILVER .925 – HALF ROUND

Stock #	Description	Qty.	Approx. Length / 1/2 ozt.	
MET-310.16	16 gauge	1/2 ozt	8.5	\$16.97
MET-310.18	18 gauge	1/2 ozt	12	\$16.97
MET-310.21	21 gauge	1/2 ozt	19	\$16.97

STERLING SILVER .925 – SQUARE

Stock #	Description	Qty.	Approx. Length / 1/2 ozt.	
MET-315.16	16 gauge	1/2 ozt	3	\$16.97
MET-315.18	18 gauge	1/2 ozt	4.75	\$16.97
MET-315.20	20 gauge	1/2 ozt	8.5	\$16.97

FINE SILVER .999 – ROUND

Stock #	Description	Qty.	Approx. Length / 1/2 ozt.	
MET-380.20	20 gauge	1/2 ozt	9.4	\$18.12
MET-380.22	22 gauge	1/2 ozt	14.9	\$18.12

STERLING SILVER .925 – SHEET

Stock #	Description	Qty.	
MET-320.20	20 gauge	6" x 1" sheet	\$34.38
MET-320.26	26 gauge	6" x 2" sheet	\$34.38

STERLING SILVER .925 – BEZEL

Stock #	Description	Qty.	
MET-350.30	5mm, 28 Gauge	12"	\$6.05

We welcome special requests for silver sizes and lengths not listed as well as platinum, palladium and gold. Minimum quantities may apply. Usually delivered in seven days.

Due to the changes in market prices, silver pricing is subject to change.

COPPER SHEET

Prime quality 18 gauge (.04", 1mm) copper which is both oxygen and phosphorous free. Pair with other metals or use by itself and polish to a high luster. Also may be used for enameling and stamping.

Stock #	Shape	Size	Qty.	
MET-110.30	Square	1/2"	pk/6	\$3.54
MET-110.32	Square	3/4"	pk/6	\$4.46
MET-110.34	Square	1"	pk/6	\$6.23
MET-110.37	Square	1 1/2"	pk/6	\$7.08
MET-120.43	Rectangle	7/16" X 1 5/16"	pk/6	\$3.54
MET-120.47	Rectangle	1/2" x 2"	pk/6	\$4.46
MET-120.53	Rectangle	1" x 2"	pk/6	\$6.23
MET-120.40	Rectangle Sheet	4" x 6"	1 sheet	\$5.20

A

ABR-155.01 - .13	167
ABR-157.01 - .13	167
ABR-159.01 - .13	167
ABR-165.01 - .03	167
ABR-167.01 - .03	167
ABR-169.01 - .03	167
ABR-175.01 - .03	167
ABR-177.01 - .03	167
ABR-179.01 - .03	167
ABR-185.05	167
ABR-187.05	167
ABR-189.05	167
ABR-195.00	167
ABR-196.00	167
ABR-197.30	167
ABR-510.01	166
ABR-510.02	166
ABR-510.03	166
ABR-515.01	166
ABR-515.02	166
ABR-515.03	166
ABR-616.00 - .44	168
ABR-800.10 thru ABR-803.20	37
ANV-170.00	29
ANV-200.00	29
ANV-205.00	29
ANV-220.00	29
ANV-222.00	29
ANV-230.00	29
ANV-550.00	29
ANV-555.00	29
APN-200.00	35
APR-100.00	77
APR-100.05	77
APR-100.50	77
APR-105.00	77
APR-105.05	77

B

BAG-100.10	125
BAG-100.15	125
BAG-200.06	125
BAG-200.06K	125
BAG-210.05	125
BAG-210.10	125,142
BAT-200.00	221
BAT-445.00	221
BAT-500.00	222
BAT-500.05	222
BAT-500.10	222
BAT-510.00	222
BAT-600.00	221
BAT-M321	222
BAT-M364	222
BAT-M371	222
BAT-M377	222
BAT-M379	222
BAT-M395	222
BAT-MCR1216	222
BAT-MCR2016	222
BAT-MCR2025	222
BAT-MCR2032	222
BAT-MLR44	222
BDC-101.00 thru BDC-253.12	16
BDC-300.12 thru BDC-301.18	21
BDC-314.10 thru BDC-315.15	21
BDC-323.13 thru BDC-324.18	21
BDC-331.01 thru BDC-353.08	16
BDC-400.10 - .24	20
BDC-401.10 - .24	20
BDC-414.00 - .60	20
BDC-415.00 - .60	20
BDC-419.00 - .60	20
BDC-420.00 - .60	20
BDC-424.00 - .60	20
BDC-425.00 - .60	20
BDC-431.00 - .23	20
BDC-434.00 - .23	20
BDC-439.00 - .23	20

BDC-450.00 thru BDC-461.02	17
BDC-470.00 thru BDC-482.00	17
BDC-501.00 thru BDC-524.05	17
BDC-551.05 - .21	15
BDC-553.05 - .31	15
BDC-555.05 - .21	15
BDC-631.00 - .03	17
BDC-703.12 thru BDC-749.24	22
BDC-752.12 - .24	21
BDC-762.12 thru BDC-763.24	21
BDC-770.14 - .24	20
BDC-771.14 - .24	20
BDC-772.24	21
BDC-774.18	21
BDC-774.24	21
BDC-790.10	22
BDC-791.10	22
BDC-792.10	22
BDC-793.10	22
BDC-794.10	22
BDC-803.01 thru BDC-809.23	18
BDC-823.40 thru BDC-828.40	19
BDC-833.01 thru BDC-835.24	19
BDC-851.01 thru BDC-861.26	19
BDK-110.00	3
BDK-400.00	9
BDK-410.00	9
BDN-104.04 - .15	15
BDN-760.00	15
BDN-762.00	15
BDN-764.00	15
BDP-391.00	73
BDR-100.00 - .22	73
BDR-120.00	73
BDS-100.05	14
BDS-100.06	14
BDS-102.05	14
BDS-102.06	14
BDS-104.05	14
BDS-104.06	14
BDS-110.05	14
BDS-110.06	14
BDS-112.06	14
BDS-115.06	14
BDS-117.06	14
BDS-118.06	14
BDS-210.05	14
BDS-210.06	14
BDS-210.16	14
BDS-215.05	14
BDS-215.06	14
BDS-215.16	14
BDS-233.05	14
BDS-233.06	14
BDS-233.16	14
BDS-234.05	14
BDS-234.06	14
BDS-234.16	14
BDS-243.05	14
BDS-243.06	14
BDS-243.16	14
BDS-244.05	14
BDS-244.06	14
BDS-244.16	14
BDS-303.16	14
BDS-305.16	14
BDS-307.05	14
BDS-307.06	14
BDS-308.05	14
BDS-308.06	14
BDS-308.16	14
BDS-323.06	14
BDS-324.06	14
BDS-408.05	14
BDS-408.06	14
BDS-409.05	14
BDS-409.06	14
BDS-410.05	14
BDS-410.06	14
BDS-411.05	14
BDS-411.06	14
BDS-412.05	14

BDS-412.06	14
BDT-100.28	12
BDT-100.40	12
BDT-101.34	12
BDT-102.34	12
BDT-104.20	12
BDT-105.42	12
BDT-113.42	12
BDT-200.00	12
BDT-250.00	15
BDT-330.00	12
BDT-335.01	12
BDT-335.02	12
BDT-335.03	12
BEA-100.03	23
BEA-100.05	23
BEA-100.20	23
BEN-100.00	35
BEN-310.00	28
BEN-404.00	29,109
BLO-665.00	232
BLO-666.00	232
BLO-666.50	232
BLO-851.01 thru BDC-851.26	19
BPN-103.00	28
BPN-103.02	28
BPN-103.08	28
BPN-105.00	28
BPN-105.10	28
BPN-106.10	28
BPN-106.50	185
BPN-107.10	28,184
BPN-120.00	28,185
BPN-122.00	28
BPN-122.02	28
BPN-122.08	28
BPN-123.00	30
BPN-130.00	29
BRN-100.10	74
BRN-100.15	74
BRN-100.20	74
BRN-100.25	74
BRN-150.00	74
BRN-150.20	74
BRN-150.30	74
BRN-200.10	74
BRN-200.15	74
BRN-200.20	74
BRN-200.25	74
BRN-210.25	74
BRN-215.25	74
BRN-300.00	74
BRN-300.15	74
BRN-300.30	74
BRN-300.50	74
BRN-405.12	74
BRN-405.18	74
BRN-405.36	74
BRN-410.12	74
BRN-410.18	74
BRN-410.36	74
BRN-418.00	76
BRN-600.20	74
BRN-600.30	74
BRN-620.05	74,177
BRN-620.06	74,177
BRO-140.00	233
BRO-174.00	233
BRS-160.00	38
BRS-210.00	38
BRS-210.05	38
BRS-210.10	38
BRS-212.00	38
BRS-215.00	38
BRS-220.00	38
BRS-225.00	38
BRS-230.00	38
BRS-270.00	171
BRS-271.00	171
BRS-274.00	167
BRS-275.00	167

BRS-277.00	167
BRS-277.10	167
BRS-278.00	166
BRS-278.50	166
BRS-279.00	167
BRS-280.00	171
BRS-282.00	167
BRS-284.00	167
BRS-285.00	167
BRS-287.10	167
BRS-290.00	40
BRS-290.01	40
BRS-292.00	40
BRS-292.01	40
BRS-293.00	40
BRS-293.01	40
BRS-294.00	40,222
BRS-294.01	40
BRS-294.50	40
BRS-295.00	40
BRS-295.01	40
BRS-300.10	38
BRS-302.10	38
BRS-305.10	38
BRS-310.10	38
BRS-312.10	38
BRS-315.10	38
BRS-359.01 - .04	39
BRS-400.00 thru BRS-475.00	38
BRS-495.00	40,177
BRS-710.00	204
BRS-715.00	204
BRS-804.00	38
BRS-806.00	38
BRS-896.01 - .09	175
BRS-897.21	175
BRS-897.22	175
BRS-962.00	39
BRS-964.05	39
BRS-964.10	39
BRS-965.00	39
BRS-966.05	39
BRS-966.10	39
BRS-967.00	39
BRS-967.05	39
BRS-968.00	39
BRS-969.10	39
BRS-972.00	39,221
BRS-973.00	39,221
BRS-980.05	40,204
BUF-115.00	41
BUF-512.00 - .21	40
BUF-530.10	40
BUF-550.10	40
BUF-633.54	41
BUF-634.54	41
BUF-635.54	41
BUF-636.54	41
BUF-653.35	41
BUF-654.50	41
BUF-655.50	41
BUF-656.50	41
BUF-663.30	41
BUF-664.50	41
BUF-665.50	41
BUF-666.50	41
BUF-683.35	41
BUF-684.50	41
BUF-685.50	41
BUF-686.50	41
BUF-693.35	41
BUF-694.50	41
BUF-694.60	41
BUF-695.50	41
BUF-696.50	41
BUF-702.07	41
BUF-704.05	41
BUF-704.07	41
BUF-712.07	41
BUF-714.05	41
BUF-714.07	41
BUF-714.10	41

BUF-749.03	166
BUF-750.05 - .40	166
BUF-751.03 - .98	166
BUF-752.07	41
BUF-753.03 - .98	166
BUF-754.07	41
BUF-903.10	171
BUF-903.20	171
BUR-000.10	46
BUR-000.12	46
BUR-040.80 thru BUR-041.80	47
BUR-180.00	44,80
BUR-261.80	10
BUR-300.01 - .54	44
BUR-301.02 - .52	44
BUR-302.05 - .30	44
BUR-303.05 - .30	44
BUR-304.01 - .34	44
BUR-304.52 - .54	44
BUR-306.01 - .34	45
BUR-306.51 - .54	44
BUR-307.02 - .34	45
BUR-307.50 - .53	44
BUR-308.02 - .34	45
BUR-308.50 - .52	44
BUR-309.05 - .34	45
BUR-309.50	44
BUR-310.05 - .34	45
BUR-311.02 - .30	45
BUR-311.50	44
BUR-312.05 - .34	45
BUR-312.50	44
BUR-313.09 - .19	45
BUR-314.26 - .30	45
BUR-350.00	48
BUR-400.00	46
BUR-416.00	46
BUR-500.00	42
BUR-500.01	42
BUR-500.05	42
BUR-500.50 thru BUR-505.00	43
BUR-510.00	42
BUR-510.80 thru BUR-515.00	43
BUR-520.00	42
BUR-520.60 thru BUR-522.30	43
BUR-540.00	42
BUR-540.05	42
BUR-541.00 thru BUR-545.00	43
BUR-560.00	42
BUR-560.05	42
BUR-560.80 thru BUR-565.00	43
BUR-570.00	42
BUR-570.01	42
BUR-570.02	42
BUR-570.05	42
BUR-570.90 thru BUR-575.00	43
BUR-580.00	42
BUR-580.80 thru BUR-585.00	43
BUR-590.00	42
BUR-590.60 thru BUR-592.30	43
BUR-610.00	42
BUR-610.70 thru BUR-612.30	43
BUR-621.00 thru BUR-622.30	43
BUR-700.50 thru BUR-782.30	46
BUR-801.00	43
BUR-801.20	43
BUR-905.24	47
BUR-906.00	47
BUR-925.00	47
BUR-930.00	47
BUR-930.05	47
BUR-935.00	47
BUR-935.05	47
BUR-940.00	47
BUR-950.00	47
BUR-970.00	46,83
BUR-972.00	46,83
BUR-974.00	46,83
BUR-976.00	46,83
BUR-978.19	46,83
BUR-978.26	46,83

C

BUR-978.30	46,83
BUR-978.34	46,83
CAS-100.00	56
CAS-112.00	57
CAS-128.00	58
CAS-136.00	57
CAS-169.00	57
CAS-230.00	57
CAS-235.00	57
CAS-236.00	57
CAS-236.01	57
CAS-250.01	57
CAS-250.02	57
CAS-250.10	57
CAS-250.20	57
CAS-250.98	57
CAS-300.01 - .04	56
CAS-304.00	56
CAS-310.01	56
CAS-310.05	56
CAS-310.08	56
CAS-320.01	56
CAS-320.02	56
CAS-320.05	56
CAS-320.06	56
CAS-320.15	56
CAS-320.18	56
CAS-330.01	56
CAS-330.02	56
CAS-330.05	56
CAS-330.06	56
CAS-330.05	56
CAS-330.06	56
CAS-415.00	52
CAS-430.00	52
CAS-520.05	58
CAS-521.05	58
CAS-522.05	58
CAS-530.05	58
CAS-531.05	58
CAS-532.05	58
CAS-540.01	58
CAS-540.02	58
CAS-540.08	58
CAS-542.05	58

CLN-609.08.....	59	CVR-505.10.....	5,49	DAP-708.00.....	111	DIB-500.00.....	81	ELP-510.00.....	117,236	FIL-500.30.....	83
CLN-609.12.....	59	CVR-505.15.....	5,49	DAP-712.00.....	110	DIB-501.50.....	81	ELP-522.00.....	117,236	FIL-511.30.....	83
CLN-609.50.....	59	CVR-510.00.....	49	DAP-713.00.....	110	DIB-502.00.....	81	ELP-523.00.....	117,236	FIL-521.30.....	83
CLN-630.00.....	61	CVR-512.00.....	49	DAP-714.00.....	110	DIB-502.50.....	81	ELP-524.00.....	117,236	FIL-600.20.....	68,87
CLN-632.00.....	61	CVR-530.00.....	50	DAP-724.00.....	110	DIB-503.00.....	81	ELP-525.00.....	117,236	FIL-605.20.....	68,87
CLN-634.00.....	60	CVR-550.01.....	49	DEM-345.00.....	234	DIB-504.00.....	81	ELP-527.00.....	117,236	FIL-610.20.....	68,87
CLN-635.00.....	60	CVR-550.02.....	49	DIA-130.00.....	72	DIB-505.00.....	81	ELP-530.00.....	117,236	FIL-615.20.....	68,87
CLN-640.00.....	61	CVR-550.03.....	49	DIA-133.00.....	72	DIB-506.50.....	81	ELP-540.00 - .07.....	117	FIL-620.20.....	68,87
CLN-643.00.....	61	CVR-550.05.....	49	DIA-134.00.....	72	DIB-509.50.....	81	ELP-550.00.....	117,236	FIL-653.00.....	85
CLN-645.00.....	60	CVR-550.06.....	49	DIA-160.00.....	76	DIB-510.00.....	81	ELP-550.10.....	117	FIL-655.00.....	85
CLN-645.10.....	60	CVR-550.07.....	49	DIA-163.00.....	76	DIB-511.00.....	81	ELP-550.40.....	116,236	FIL-663.00.....	85
CLN-650.00.....	60	CVR-550.12.....	49	DIA-210.00.....	115,209	DIB-550.00.....	81	ELP-555.00.....	116	FIL-671.00.....	68,87
CLN-650.10.....	60	CVR-560.00.....	50	DIA-220.00.....	115,209	DIB-550.75.....	81	ELP-558.00.....	117	FIL-673.00.....	68,87
CLN-650.20.....	60	CVR-610.00.....	51	DIA-220.10.....	115,209	DIB-551.00.....	81	ELP-560.02.....	116	FIL-700.00.....	86
CLN-651.00.....	60	CVR-610.05.....	51	DIA-225.00.....	115,209	DIB-551.25.....	81	ELP-560.04.....	114	FIL-705.00.....	86
CLN-651.10.....	60	CVR-610.10.....	51	DIA-225.10.....	115,209	DIB-551.50.....	81	ELP-570.03 - .17.....	117	FIL-710.00.....	86
CLN-651.20.....	60	CWR-167.00.....	231	DIA-252.00.....	23,70	DIB-552.00.....	81	ELP-576.42 - .48.....	116	FIL-715.00.....	86
CLN-652.10.....	60	CWR-170.00.....	33,231	DIA-253.00.....	70	DIB-552.50.....	81	ELP-590.20 - .50.....	116	FIL-720.00.....	86
CLN-652.20.....	60	CWR-175.00.....	231	DIA-253.10.....	70	DIB-552.50.....	81	ELP-722.02.....	120	FIL-725.00.....	86
CLN-653.10.....	60	CWR-175.04.....	231	DIA-254.00.....	23,70	DIB-700.01.....	67	ELP-722.03.....	120	FIL-740.00 - .05.....	49
CLN-653.20.....	60	CWR-177.00.....	224	DIA-255.00.....	70	DIB-700.50.....	67	ELP-724.01.....	120	FIL-750.00 - .10.....	49
CLN-675.00.....	61	CWR-180.00.....	231	DIA-256.00.....	70	DIB-700.51.....	67	ELP-725.01.....	120	FIL-755.00.....	49
CLN-700.10.....	61	CWR-568.00.....	226	DIA-260.00.....	23	DIB-701.00 thru DIB-724.51.....	67	ELP-742.00.....	118	FIL-900.05.....	86
CLN-720.10.....	61	CWR-573.00.....	226	DIA-262.00.....	23,70	DIS-200.02.....	78	ELP-744.01.....	118	FIL-905.00.....	86
CLN-800.03.....	64	CWR-574.00.....	226	DIA-301.01.....	72	DIS-200.03.....	78	ELP-744.02.....	118	FIL-911.10.....	82
CLN-800.10.....	64	CWR-580.00.....	225	DIA-301.02.....	72	DIS-210.02.....	78	ELP-744.03.....	118	FIL-911.20.....	82
CLN-835.05.....	62	CWR-600.00.....	225	DIA-301.04.....	72	DIS-210.03.....	78	ELP-745.01.....	118	FIL-911.30.....	82
CLN-835.10.....	62	CWR-600.01.....	225	DIA-301.05.....	72	DIS-218.00.....	128	ELP-745.02.....	118	FIL-912.10.....	82
CLN-845.05.....	62	CWR-600.02.....	225	DIA-303.06.....	72	DIS-219.00.....	128	ELP-745.03.....	118	FIL-912.20.....	82
CLN-845.10.....	62	CWR-600.03.....	225	DIA-303.08.....	72	DIS-936.00.....	80	ELP-746.01.....	118	FIL-912.30.....	82
CLN-850.01.....	63	CWR-600.04.....	225	DIA-303.09.....	72	DIV-300.00.....	95	ELP-746.02.....	118	FIL-950.10.....	83
CLN-850.10.....	63	CWR-600.07.....	225	DIA-305.00.....	72,232	DIV-300.99.....	95	ELP-746.03.....	118	FIL-950.20.....	83
CLN-850.15.....	63	CWR-600.09.....	225	DIA-308.00.....	70	DIV-310.00.....	95	ELP-747.01.....	118	FIL-950.30.....	83
CLN-855.02.....	64	CWR-600.10.....	225	DIA-309.00.....	70	DIV-320.00.....	95	ELP-747.02.....	118	FIL-965.00.....	68,87
CLN-855.04.....	64	CWR-650.00.....	224	DIA-310.00.....	128	DIV-320.05.....	95	ELP-747.03.....	118	FIL-970.00.....	68,87
CLN-855.08.....	64	CWR-650.01.....	224	DIA-320.00.....	77	DIV-326.00.....	95	ELP-750.01.....	119	FIL-972.00.....	68,87
CLN-870.15.....	63	CWR-650.02.....	224	DIA-322.00.....	77	DIV-330.00.....	95	ELP-750.02.....	119	FIL-974.00.....	68,87
CLN-901.00.....	65	CWR-650.03.....	224	DIA-324.00.....	77	DIV-400.99.....	95	ELP-750.03.....	119	FIL-986.10.....	86
CLN-903.00.....	13	CWR-650.04.....	224	DIA-328.00.....	77	DRA-120.00.....	105	ELP-753.04.....	119	FIL-990.00.....	86
CLN-905.00.....	65	CWR-650.05.....	224	DIA-333.00.....	70	DRA-410.00.....	105	ELP-753.05.....	119	FIL-991.00.....	86
CLN-905.10.....	65	CWR-650.06.....	224	DIA-335.00.....	70	DRA-410.15.....	105	ELP-753.06.....	119	FIL-991.50.....	86
CLN-907.01.....	65,221	CWR-650.07.....	224	DIA-336.00.....	77	DRA-410.20.....	105	ELP-753.07.....	119	FIL-992.50.....	85
CLN-907.02.....	65,221	CWR-650.08.....	224	DIA-337.00.....	77	DRA-410.30.....	105	ELP-753.08.....	119	FIL-993.00.....	85
CLN-908.01.....	65,221	CWR-650.10.....	224	DIA-338.00.....	115,209	DRA-410.40.....	105	ELP-755.00.....	118	FIL-994.00.....	85
CLN-909.01.....	65,221	CWR-655.00.....	224	DIA-400.65.....	128	DRA-410.50.....	105	ELP-757.00.....	119	FIL-995.00.....	85
CLN-912.00.....	65,221	CWR-656.00.....	224	DIA-510.10.....	210	DRA-452.00.....	105	ELP-757.01.....	119	FIL-995.21 - .30.....	85
CLN-920.00.....	65	CWR-770.00.....	225	DIA-510.20.....	210	DRA-553.00.....	105	ELP-758.00.....	119	FIL-996.00.....	85
CRY-179.00.....	232	CWR-770.01.....	225	DIA-510.50.....	210	DRA-555.00.....	105	ELP-759.01.....	119	FIL-996.21 - .30.....	85
CRY-904.00.....	223	CWR-770.02.....	225	DIA-600.00.....	210	DRA-572.00.....	105	ELP-759.13.....	119	FIL-998.00.....	86
CRY-905.00.....	223	CWR-770.03.....	225	DIA-620.00.....	210	DRA-574.00.....	105	ELP-760.10.....	118	FIL-999.00.....	86
CRY-905.10.....	223	CWR-770.04.....	225	DIA-650.00.....	210	DRA-678.00.....	105	ELP-760.15.....	118	FLY-100.90 thru FLY-201.80.....	69
CRY-905.15.....	223	CWR-770.05.....	225	DIA-651.00.....	210	DRA-680.00.....	105	ELP-761.10.....	118		
CRY-905.20.....	223	CWR-771.00.....	225	DIB-100.02 thru DIB-170.10.....	66	DRL-183.00.....	80	ELP-763.00.....	118		
CRY-905.25.....	223	CWR-777.00.....	226	DIB-180.10 - .60.....	67	DRL-200.00.....	79	ELP-765.17.....	119		
CRY-908.00.....	224	CWR-778.00.....	226	DIB-210.00.....	81	DRL-226.50 - .80.....	79	ELP-765.23.....	119	G01-525B.....	97
CRY-908.10.....	224	CWR-780.00.....	225	DIB-210.70.....	81	DRL-227.00 - .80.....	79	ELP-768.01.....	119	G02-055.....	97
CRY-910.00.....	224	CWR-780.10.....	225	DIB-210.90.....	81	DRL-228.50 - .80.....	79	ELP-800.03.....	114	G02-138.....	97
CVR-105.00.....	51			DIB-211.00.....	81	DRL-230.00.....	80	ELP-801.00.....	120,236	G02-139.....	97
CVR-220.00.....	51			DIB-211.20.....	81	DRL-240.00.....	80	ELP-801.50.....	120,236	G03-021.....	97
CVR-243.00.....	175			DIB-211.40.....	81	DRL-245.06.....	80	ELP-802.00.....	120,236	G03-520.....	97
CVR-250.00.....	175	DAP-114.00.....	110	DIB-211.60.....	81	DRL-245.07.....	80	ELP-802.50.....	120,236	G03-522.....	97
CVR-254.00.....	175	DAP-125.00.....	110	DIB-212.01.....	66	DRL-245.12.....	80	ELP-829.00.....	120	G03-530.....	97
CVR-255.03.....	175	DAP-126.00.....	110	DIB-212.02.....	66	DRL-245.13.....	80	ELP-830.00.....	120	G03-531.....	97
CVR-312.00 - .60.....	50	DAP-127.00.....	110	DIB-213.01.....	66	DRL-245.52 - .76.....	80	ELP-835.00.....	120	G03-570.....	97
CVR-400.10.....	50	DAP-128.00.....	110	DIB-213.02.....	66	DRL-250.00 thru DRL-251.60.....	79	ELP-836.00.....	120	G03-683.....	97
CVR-400.20.....	50	DAP-130.00.....	109	DIB-220.00.....	66			ELP-837.00.....	120	G03-684.....	97
CVR-400.30.....	9,50	DAP-200.00.....	109	DIB-224.00.....	67			ELP-871.50.....	116	G04-542.....	96
CVR-410.05.....	50	DAP-249.00.....	111	DIB-225.00.....	67			ELP-872.00.....	116	G04-555.....	96
CVR-410.20.....	50	DAP-350.00.....	111	DIB-225.01.....	67			ELP-872.50.....	116	G04-556.....	96
CVR-410.35.....	50	DAP-352.00.....	111	DIB-226.00.....	67			ELP-873.50.....	116	G04-557.....	96
CVR-410.45.....	50	DAP-354.00.....	111	DIB-227.00 - .65.....	81			ELP-880.00.....	116	G04-559.....	96
CVR-410.55.....	50	DAP-400.00.....	111	DIB-261.05.....	5,68			ELP-881.00.....	116	G04-568.....	96
CVR-420.30.....	50	DAP-400.10.....	111	DIB-270.01.....	5,68			ENV-100.00.....	127	G04-570.....	96
CVR-430.10.....	51	DAP-410.00.....	111	DIB-271.50.....	5,68			ENV-100.05.....	127	G04-571.....	96
CVR-430.20.....	51	DAP-410.10.....	111	DIB-274.00.....	5,69			ENV-200.00.....	127	G04-589.....	96
CVR-430.25.....	51	DAP-430.00.....	111	DIB-275.00.....	5,69			ENV-210.00.....	127	G04-642.....	183
CVR-500.00.....	50	DAP-500.30.....	29,109	DIB-275.01.....	5,69					G04-674.....	96
CVR-500.10.....	50	DAP-503.00.....	109	DIB-275.02.....	5,69					G04-679.....	97
CVR-500.15.....	50	DAP-525.00.....	109	DIB-275.05.....	5,69					G04-725.....	96
CVR-500.20.....	50	DAP-525.10.....	109	DIB-275.40.....	5,69					GAU-110.00.....	94
CVR-500.25.....	50	DAP-540.00.....	109	DIB-275.55.....	5,69					GAU-110.05.....	94
CVR-500.50.....	50	DAP-540.10.....	109	DIB-300.00.....	69					GAU-110.10.....	94
CVR-505.05.....	5,49	DAP-705.00.....	111							GAU-120.00.....	94

G

PLR-140.00.....	156	PLR-430.30.....	141	PLR-700.00.....	153	PLR-800.10.....	140	POL-288.00.....	171	PUB-127.00.....	182
PLR-140.05.....	156	PLR-430.50.....	141	PLR-7000.....	129	PLR-800.15.....	140	POL-288.10.....	171	PUB-128.00.....	181
PLR-140.06.....	156	PLR-430.90.....	24,141	PLR-7000RX.....	129	PLR-804.00.....	140	POL-288.50.....	171	PUB-133.00.....	181
PLR-150.00.....	132	PLR-450.00.....	135	PLR-705.00.....	153	PLR-8100.....	131	POL-300.10 thru		PUB-135.00.....	182
PLR-155.00.....	153	PLR-460.00.....	159	PLR-708.00.....	153	PLR-8100RX.....	130	POL-331.40.....	169	PUB-140.00.....	182
PLR-158.00.....	152	PLR-461.00.....	7,159	PLR-711.00.....	153	PLR-8130.....	131	POL-370.02 thru		PUB-141.00.....	182
PLR-159.00.....	152	PLR-461.50.....	7,159	PLR-715.00.....	151	PLR-814.00.....	155	POL-391.33.....	168	PUB-151.00.....	180
PLR-160.00.....	152	PLR-463.50.....	159	PLR-718.00.....	150	PLR-814.01.....	155	POL-392.01.....	168	PUB-162.00.....	180
PLR-165.00.....	152	PLR-467.50.....	159	PLR-718.24.....	150	PLR-814.15.....	155	POL-392.02.....	168	PUB-164.00.....	180
PLR-180.00 - 98.....	133	PLR-469.10.....	7,159	PLR-7190.....	131	PLR-8140.....	131	POL-392.03.....	168	PUB-166.00.....	180
PLR-250.00.....	141	PLR-469.11.....	7,159	PLR-7191.....	131	PLR-8140RX.....	130	POL-394.01.....	168	PUB-168.00.....	180
PLR-250.05.....	141	PLR-469.20.....	159	PLR-720.00.....	144	PLR-8141.....	131	POL-394.02.....	168	PUB-180.00.....	181
PLR-250.10.....	141	PLR-470.00.....	7,160	PLR-720.05.....	144	PLR-8141RX.....	130	POL-394.03.....	168	PUB-185.00.....	181
PLR-250.35.....	141	PLR-470.00L.....	160	PLR-721.05.....	144	PLR-8142.....	131	POL-400.05.....	168	PUB-520.01.....	182
PLR-255.00.....	136	PLR-470.10.....	7,160	PLR-722.00.....	144	PLR-8144.....	131	POL-400.10.....	168	PUN-100.00.....	106
PLR-255.00G.....	136	PLR-470.10L.....	160	PLR-722.05.....	144	PLR-8144.....	131	POL-400.15.....	168	PUN-100.01 / 26.....	106
PLR-255.05.....	136	PLR-470.50.....	160	PLR-724.00.....	144	PLR-8145.....	131	POL-410.20 thru		PUN-101.00.....	106
PLR-255.05G.....	136	PLR-471.00.....	160	PLR-724.50.....	144	PLR-8147.....	131	POL-411.23.....	169	PUN-101.14 / 79.....	106
PLR-255.10.....	136	PLR-473.00.....	160	PLR-725.00.....	143	PLR-8147RX.....	130	POL-420.60 thru		PUN-102.00.....	106
PLR-255.10G.....	136	PLR-474.00.....	160	PLR-728.00.....	157	PLR-815.00.....	155	POL-430.80.....	169	PUN-102.01 / 39.....	106
PLR-255.15.....	136	PLR-477.00.....	7,161	PLR-729.00.....	157	PLR-815.05.....	155	POL-455.00.....	169	PUN-103.00.....	106
PLR-255.15G.....	136	PLR-477.50.....	7,161	PLR-729.05.....	157	PLR-8150.....	131	POL-460.01 thru		PUN-103.09 / 49.....	106
PLR-255.18G.....	136	PLR-480.00 - 99.....	138	PLR-7291.....	131	PLR-8150RX.....	130	POL-480.09.....	169	PUN-105.70.....	107
PLR-255.30G.....	136,145	PLR-487.00.....	7,158	PLR-730.00.....	144	PLR-8151.....	131	POL-490.50 - 80.....	169	PUN-105.75.....	107
PLR-255.35G.....	136,147	PLR-488.00.....	158	PLR-730.05.....	144	PLR-8152.....	131	POL-600.00.....	170	PUN-105.80.....	107
PLR-255.50.....	136	PLR-489.00.....	158	PLR-731.00.....	157,237	PLR-8152RX.....	130	POL-601.00.....	170	PUN-105.85.....	107
PLR-255.50G.....	136	PLR-490.00.....	140	PLR-731.50.....	157,237	PLR-8160.....	131	POL-603.00.....	232	PUN-105.94.....	107
PLR-255.80G.....	136,161	PLR-490.05.....	140	PLR-732.00.....	157	PLR-8160RX.....	130	POL-605.00.....	170	PUN-105.95.....	107
PLR-255.98.....	136	PLR-490.10.....	140	PLR-733.00.....	157	PLR-8161.....	131	POL-610.25.....	170	PUN-105.99.....	107
PLR-255.98G.....	136	PLR-490.15.....	140	PLR-734.00.....	144	PLR-8161.00.....	157	POL-612.25.....	170	PUN-106.00.....	106
PLR-255.98G.01.....	136	PLR-490.20.....	140	PLR-735.00.....	143	PLR-8180RX.....	163	POL-625.05.....	170	PUN-106.02 / 51.....	106
PLR-255.99.....	136	PLR-490.22.....	140	PLR-736.00.....	146	PLR-819.00.....	154	POL-625.10.....	170	PUN-107.00.....	106
PLR-255.99G.....	136	PLR-490.25.....	140	PLR-738.00.....	151	PLR-820.00.....	156,237	POL-625.15.....	170	PUN-107.01 / 74.....	106
PLR-255.99G.01.....	136	PLR-490.35.....	140	PLR-740.00.....	143	PLR-829.00.....	11,145	POL-625.20.....	170	PUN-108.02.....	106
PLR-260.00 - 50.....	137	PLR-490.40.....	146	PLR-745.00.....	143	PLR-829.05.....	11,145	POL-625.25.....	170	PUN-108.04.....	106
PLR-260.55.....	10,137,150	PLR-490.50.....	140	PLR-746.02.....	8,146	PLR-830.00.....	11	POL-625.30.....	170	PUN-108.44.....	106
PLR-260.98.....	137	PLR-490.98.....	140	PLR-746.03.....	8,146	PLR-830.05.....	11	POL-625.35.....	170	PUN-109.01 / 20.....	106
PLR-270.00.....	142	PLR-491.35.....	147	PLR-746.14.....	146	PLR-831.00.....	11	POL-625.40.....	170	PUN-110.01.....	107
PLR-270.05.....	142	PLR-491.36.....	147	PLR-746.19.....	146	PLR-831.05.....	11	POL-680.00.....	64	PUN-110.02.....	107
PLR-270.10.....	142	PLR-495.00.....	140	PLR-747.00.....	8,146	PLR-833.00.....	154	POL-690.00.....	173	PUN-110.03.....	107
PLR-270.15.....	142	PLR-495.05.....	140	PLR-748.00.....	8,146	PLR-835.00.....	145	POL-695.00.....	64,174	PUN-110.04.....	107
PLR-270.55.....	142	PLR-495.10.....	140	PLR-7490.....	131	PLR-835.05.....	145	POL-700.00.....	174	PUN-114.01.....	107
PLR-275.00.....	137	PLR-495.15.....	140	PLR-7490RX.....	130	PLR-840.00.....	145	POL-705.00.....	174	PUN-114.02.....	107
PLR-275.05.....	137	PLR-495.25.....	143	PLR-750.25.....	143	PLR-840.05.....	145	POL-710.00.....	174	PUN-114.03.....	107
PLR-275.10.....	137	PLR-495.35.....	143	PLR-750.35.....	143	PLR-841.00.....	145	POL-715.00.....	174	PUN-114.04.....	107
PLR-275.15.....	137	PLR-495.40.....	143	PLR-750.40.....	143	PLR-841.05.....	145	POL-745.00.....	65,174	PUN-118.01.....	107
PLR-275.30.....	137,145	PLR-495.45.....	143	PLR-750.45.....	143	PLR-842.00.....	151	POL-804.00.....	173	PUN-118.02.....	107
PLR-275.35.....	137,147	PLR-495.50.....	140	PLR-751.00.....	8,147	PLR-842.05.....	151	POL-805.00.....	174	PUN-118.03.....	107
PLR-275.46.....	137	PLR-495.98.....	140	PLR-752.00.....	8,147	PLR-845.00.....	156,230	POL-807.00.....	173	PUN-118.04.....	107
PLR-275.50.....	137	PLR-515.00.....	161	PLR-753.00.....	8,147	PLR-845.05.....	156,230	POL-807.04.....	173	PUN-124.01.....	107
PLR-275.80.....	137,161	PLR-560.00.....	151	PLR-754.00.....	154	PLR-846.00.....	147	POL-812.02.....	173	PUN-124.02.....	107
PLR-275.98.....	137	PLR-572.00.....	148	PLR-754.50.....	154	PLR-846.05.....	147	POL-812.03.....	173	PUN-124.03.....	107
PLR-300.00.....	134	PLR-573.00.....	148	PLR-755.00.....	154	PLR-847.00.....	147	POL-813.01.....	173	PUN-124.04.....	107
PLR-300.10.....	134	PLR-574.00.....	148	PLR-756.00.....	153	PLR-847.05.....	147	POL-813.02.....	173	PUN-125.00.....	107
PLR-300.22.....	134	PLR-575.00.....	148	PLR-7590.....	131	PLR-848.00.....	31,154	POL-813.03.....	173	PUN-125.01.....	107
PLR-301.35.....	151	PLR-576.00.....	148	PLR-7590RX.....	130	PLR-848.05.....	31,154	POL-908.01S.....	173	PUN-125.20.....	107
PLR-302.00.....	134	PLR-577.00.....	9,148	PLR-760.00.....	162	PLR-850.00.....	158	POL-908.02S.....	173	PUN-125.40.....	107
PLR-302.02.....	134	PLR-577.10.....	9,148	PLR-762.00.....	162	PLR-855.00.....	158	POL-908.04.....	173	PUN-126.00.....	107
PLR-305.00.....	134	PLR-578.04.....	13,150	PLR-765.00.....	161	PLR-856.00.....	158	PSH-100.00.....	229	PUN-126.10.....	107
PLR-305.10.....	134	PLR-578.05.....	13,150	PLR-766.00.....	161	PLR-860.00.....	158	PSH-120.00.....	229	PUN-127.00.....	107
PLR-305.22.....	134	PLR-580.00.....	142	PLR-781.00.....	7,161	PLR-865.00.....	158	PSH-125.00.....	229	PUN-127.10.....	107
PLR-307.00.....	134	PLR-580.05.....	142	PLR-781.50.....	7,161	PLR-866.00.....	158	PSH-125.01.....	229	PUN-128.02.....	107
PLR-310.00.....	134	PLR-580.10.....	142	PLR-784.00.....	161	PLR-867.00.....	158	PSH-129.00.....	75	PUN-129.02.....	107
PLR-310.10.....	134	PLR-580.50.....	142	PLR-7890.....	131	PLR-868.00.....	108	PSH-135.10.....	75	PUN-130.00.....	107
PLR-312.00.....	134	PLR-580.60.....	9,142	PLR-7890RX.....	130	PLR-868.01.....	108	PSH-145.00.....	75	PUN-130.10.....	107
PLR-315.00.....	134	PLR-580.99.....	142	PLR-7892.....	131	PLR-870.00.....	153	PSH-150.00 thru		PUN-131.00.....	107
PLR-320.00.....	134	PLR-582.00.....	2,149	PLR-7892RX.....	130	PLR-956.00.....	164	PSH-235.00.....	229	PUN-131.10.....	107
PLR-350.00.....	134	PLR-584.00.....	2,149	PLR-7893.....	131	PLR-957.00.....	164	PSH-770.00.....	76	PUN-140.00.....	107
PLR-351.00.....	151	PLR-585.00.....	2,149	PLR-7893RX.....	130	PLR-957.05.....	164	PSH-771.00.....	76	PUN-400.00.....	108
PLR-355.00.....	153	PLR-586.00.....	2	PLR-790.00.....	163	PLR-957.10.....	164	PSH-775.00.....	76	PUN-400.01.....	108
PLR-360.00 - 98.....	139	PLR-588.00.....	10,150	PLR-791.00.....	163	PLR-957.98.....	164	PSH-776.00.....	76	PUN-400.02.....	108
PLR-380.00 - 50.....	133	PLR-589.00.....	10,150	PLR-794.55.....	162	PLR-958.20.....	162	PUB-107.00.....	181	PUN-410.00.....	108
PLR-400.00.....	135	PLR-590.00 - 98.....	138	PLR-794.57.....	162	POL-167.00.....	174	PUB-110.00.....	181	PUN-450.00.....	109
PLR-400.99.....	135	PLR-595.00 - 99.....	139	PLR-795.00.....	163	POL-168.00.....	174	PUB-113.00.....	181		
PLR-405.00.....	135	PLR-660.00.....	162	PLR-796.00.....	163	POL-169.00.....	174	PUB-114.00.....	181		
PLR-410.00.....	135	PLR-661.00.....	162	PLR-796.10.....	163	POL-170.00.....	174	PUB-115.50.....	180		
PLR-415.00.....	135	PLR-665.00.....	162	PLR-796.20.....	163	POL-171.00.....	174	PUB-117.00.....	180		
PLR-430.00.....	141	PLR-666.00.....	162	PLR-796.80.....	163	POL-175.00.....	173	PUB-118.00.....	180		
PLR-430.05.....	141	PLR-685.00.....	162	PLR-798.20.....	198	POL-200.00.....	36	PUB-119.10.....	180		
PLR-430.10.....	141	PLR-689.00.....	162	PLR-799.00.....	13,154	POL-205.00.....	36	PUB-120.00.....	182		
PLR-430.15.....	141	PLR-690.00.....	164	PLR-799.50.....	13,154	POL-208.00.....	36	PUB-121.00.....	182		
PLR-430.18.....	141,148	PLR-691.00.....	164	PLR-800.00.....	140	POL-250.00.....	36	PUB-122.00.....	182		
PLR-430.20.....	141	PLR-693.00.....	164	PLR-800.05.....	140	POL-255.00.....	36	PUB-126.00.....	182		

R

RCL-507.00.....	184
RCL-507.02.....	184
RCL-535.00.....	184
RCL-537.00.....	184
RCL-650.00.....	184
RCL-652.00.....	185
RCL-653.00.....	185

RCL-653.02	185
RCL-653.20	185
RCL-655.00	184
RCL-660.10	185
RCL-665.00	185
RCL-669.00	185
ROL-108.00	177
ROL-108.01	177
ROL-800.07	175
ROL-800.09	175
ROL-800.10	175
ROL-800.12	175
ROL-800.20	175
ROL-800.22	175
RST-720.00	183
RST-740.00	183
RST-740.17	183
RST-750.00	183
RST-751.00	183

S

SAW-120.05 - .10	187
SAW-265.00 - .14	188
SAW-270.60	68,187
SAW-271.00	68,187
SAW-271.20	68,187
SAW-271.40	68,187
SAW-300.00 - .12	188
SAW-310.01 - .10	186
SAW-312.00	186
SAW-313.00	186
SAW-314.00	186
SAW-315.00	186
SAW-316.00	186
SAW-318.00	186
SAW-333.00	186
SAW-334.00	186
SAW-343.00	187
SAW-343.50	187
SAW-344.00	187
SAW-345.00	187
SAW-346.00	187
SAW-350.01 - .10	186
SAW-351.00	186
SAW-352.00	186
SAW-352.50	186
SAW-353.00	186
SAW-355.00	186
SAW-356.00	186
SAW-362.00	186
SAW-400.01 - .12	188
SAW-550.01 - .12	188
SAW-650.00	187
SAW-652.00	187
SAW-670.00	187
SAW-670.01	187
SAW-670.05	187
SAW-670.10	187
SBT-100.00	230
SBT-100.05	230
SBT-100.10	230
SBT-200.00	230
SBT-200.05	230
SBT-200.10	230
SBT-205.00	230
SBT-205.01	230
SBT-290.00	228
SBT-290.06	228
SCB-431.00	75
SCB-435.00	75
SCB-436.00	75
SCB-530.00	75
SCB-535.00	75
SCB-536.00	75
SCB-537.00	75
SCB-537.05	75
SCB-537.10	75
SCI-101.00	6,196
SCI-102.00	196
SCI-103.00	196
SCI-104.00	6,196
SCI-105.00	6,196
SCI-110.00	6,196

SCI-440.00	195
SCI-455.00	196
SCI-456.00	196
SCI-520.00	6,196
SCI-525.00	6,196
SCI-285.00	190
SCL-286.00	190
SCL-292.50	189
SCL-300.20	190
SCL-300.55	189
SCL-300.60	190
SCL-305.00	190
SCL-310.00	189
SCL-381.00	190
SCL-901.00	190
SCL-902.50	190
SCR-101.00	193
SCR-101.10	193
SCR-102.00	193
SCR-102.10	193
SCR-104.00	193
SCR-106.00	193
SCR-106.10	193
SCR-260.00	192,234
SCR-260.03	192
SCR-260.80	192,234
SCR-261.00	192,234
SCR-261.20	192,234
SCR-261.40	192,234
SCR-261.60	192,234
SCR-262.00	192,234
SCR-373.00	192,234
SCR-374.00	192,234
SCR-399.00	191
SCR-399.01	191
SCR-730.00	192
SCR-730.02	192,234
SCR-730.03 - .09	192
SCR-740.00	192
SCR-740.01	192,234
SCR-740.02	192
SCR-740.03 - .09	192
SCR-830.00	193
SCR-831.20	193
SCR-831.50	193
SCR-832.00	193
SCR-832.50	193
SCR-896.00	228
SCR-900.00	193
SCR-901.20	194
SCR-901.40	194
SCR-901.60	194
SCR-902.00	194
SCR-905.00	194
SCR-910.00	194
SCR-911.20	194
SCR-911.40	194
SCR-911.60	194
SCR-912.00	194
SCR-913.00	194
SCR-926.00	194
SCR-929.00	194
SCR-940.00	193
SCR-980.00	191,234
SCR-980.01	191
SCR-980.60 thru	
SCR-983.00	191,234
SCR-989.00	191,234
SCR-990.00	191,234
SCR-990.02	191
SCR-990.60 thru	
SCR-993.00	191
SHR-170.00	6,160
SHR-175.00	6,160
SHR-200.00	234
SHR-205.00	234
SHR-210.00	6,196
SHR-304.00	195
SHR-305.00	195
SHR-530.00 thru	
SHR-536.00	195
SHR-555.00	195

SHR-558.00	195
SHR-600.00	6,195
SHR-630.00	158
SOL-200.02 - .07	198
SOL-200.23	198
SOL-200.25	198
SOL-200.40	198
SOL-200.41	198
SOL-200.50	198
SOL-200.55	200
SOL-200.60	200
SOL-204.25	198
SOL-204.30	200
SOL-204.60	198
SOL-205.00	197
SOL-205.10	197
SOL-206.00	197
SOL-207.00	198
SOL-208.00	197
SOL-208.01	198
SOL-208.02	198
SOL-210.20	199
SOL-210.25	199
SOL-210.30	199
SOL-210.50	199
SOL-212.20	199
SOL-212.25	199
SOL-212.30	199
SOL-212.35	199
SOL-224.25	198
SOL-224.26	198
SOL-224.30	200
SOL-224.60	198
SOL-225.00	197
SOL-225.10	197
SOL-226.00	197
SOL-227.00	198
SOL-250.01 - .05	199
SOL-250.10	199
SOL-250.15	199
SOL-250.16	199
SOL-250.18	199
SOL-250.50	199
SOL-260.00	201
SOL-260.01 - .66	199
SOL-270.02 - .14	199
SOL-270.50	199
SOL-280.50	200
SOL-280.52	200
SOL-282.50	200
SOL-289.00	199
SOL-290.00	200
SOL-290.01	200
SOL-292.00	200
SOL-300.00	202
SOL-302.00	202
SOL-310.00	202
SOL-320.00	202
SOL-400.10	206
SOL-400.20	206
SOL-400.30	206
SOL-410.05	206
SOL-414.00	203
SOL-420.10	206
SOL-420.20	206
SOL-420.30	206
SOL-421.10	206
SOL-421.20	206
SOL-421.30	206
SOL-430.00	206
SOL-440.10	206
SOL-440.20	206
SOL-440.30	206
SOL-450.00	206
SOL-455.00	206
SOL-465.10	206
SOL-465.20	206
SOL-480.00	206
SOL-510.00	203
SOL-520.00	203
SOL-522.00	203
SOL-600.04	205
SOL-700.00	203
SOL-730.00	176,202
SOL-730.10	176,202

SOL-735.00	176,202
SOL-802.10	202
SOL-802.40	202
SOL-820.07	207
SOL-820.21	207
SOL-820.28	207
SOL-820.41	207
SOL-825.10	207
SOL-825.15	207
SOL-825.20	207
SOL-826.40	207
SOL-827.40	207
SOL-835.12	207
SOL-835.40	207
SOL-835.45	207
SOL-845.10	207
SOL-845.15	207
SOL-845.20	207
SOL-846.10	207
SOL-850.10 - .82	207
SOL-855.40 - .82	207
SOL-858.05 - .20	207
SOL-901.00	204
SOL-932.03	205
SOL-932.10	205
SOL-932.15	205
SOL-935.03	205
SOL-935.10	205
SOL-950.01	205
SOL-950.03	205
SOL-950.04	205
SOL-970.10	205
SOL-980.02	205
SOL-980.05	205
SPK-925.00	9,204
SPK-930.00	204
SPK-930.00G	204
SPK-930.00R	204
SPK-930.99	204
SPK-940.00	204
SPK-945.00	204
STM-110.01 thru	
STM-671.02	178-179
STN-713.00	208
STN-714.00	208
STN-718.00	208
STN-719.00	208
STN-720.00	208

T

TAP-135.00	233
TAP-135.50	233
TAP-138.00	233
TES-110.00	208
TES-114.00	208
TES-118.00	208
TES-122.00	208
TES-130.00	208
TES-132.00	208
TES-170.00	209
TES-170.10	209
TES-172.00	209
TES-172.10	209
TES-174.00	209
TES-802.00	208
TES-803.00	208
TES-804.00	208
TES-805.00	208
TES-805.62	208
TES-808.00	208
TES-810.00	208
TES-810.10	208
TRA-105.00	24,123
TRA-107.00	24,123
TRA-120.01	70,124
TRA-120.02	70,124
TRA-125.00	23
TRA-128.00	25
TRA-128.50	25
TRA-128.98	25
TRA-129.00	25
TRA-130.00	26,123
TRA-130.01	26,123

TRA-130.02	26,123
TRA-136.06	26,123
TRA-138.00	26,123
TRA-138.50	26,123
TRA-142.05	24,123
TRA-145.05	24,123
TRA-177.00	25,124
TRA-178.00	25,124
TRA-180.00	25,124
TRA-181.00	25,124
TRA-220.01	70,124
TRA-220.02	70,124
TRA-450.00	232
TUM-110.00	172
TUM-110.05	172
TUM-112.00	172
TUM-125.02	172
TUM-125.50	172
TUM-510.01	172
TUM-510.10	172
TWZ-101.70 - .76	214
TWZ-103.70 - .76	214
TWZ-104.30	11,216
TWZ-104.50	11,216
TWZ-104.84	11,216
TWZ-104.87	220
TWZ-105.70	214
TWZ-105.74	214
TWZ-120.10	214,235
TWZ-120.16	214,235
TWZ-120.40	214,235
TWZ-161.74	215
TWZ-161.76	215
TWZ-165.10	216
TWZ-171.70 - .76	215
TWZ-173.70 - .76	215
TWZ-175.10	220
TWZ-191.70	215
TWZ-191.74	215
TWZ-191.77	215
TWZ-200.04 - .60	211
TWZ-201.04 - .60	211
TWZ-202.04 - .28	211
TWZ-301.04 - .56	212
TWZ-302.04 - .56	212
TWZ-311.04 - .28	213,235
TWZ-312.04 - .56	213,235
TWZ-600.00	218
TWZ-600.10	218
TWZ-600.15	218
TWZ-602.00	218
TWZ-602.10	218
TWZ-605.00	218
TWZ-608.00	10,220
TWZ-620.00	11,216
TWZ-680.00	216
TWZ-700.00	219
TWZ-700.12	219
TWZ-700.40	177,219
TWZ-701.70	215
TWZ-701.74	215
TWZ-703.70	215
TWZ-703.74	215
TWZ-705.70	11,216
TWZ-735.10	9,220
TWZ-735.22	9,220
TWZ-735.40 - .48	217
TWZ-736.10 - .42	217
TWZ-740.00	217
TWZ-740.04	203,217
TWZ-741.00	217
TWZ-744.00	217
TWZ-745.00	217
TWZ-748.00	11,216
TWZ-750.00	218
TWZ-750.02	218
TWZ-799.00	220,235
TWZ-801.60	220
TWZ-808.00	220,235
TWZ-861.00	220
TWZ-920.01	218
TWZ-920.02	218
TWZ-935.00	219

V

VIS-100.00	30
VIS-204.00	30
VIS-204.20	30
VIS-214.10	30
VIS-215.10	30
VIS-310.00	30
VIS-311.00	30
VIS-350.00	30
VIS-510.00	30
VIS-550.00	31

W

WAT-351.00	221
WAT-352.00	221
WAT-400.05	222
WAT-400.10	222
WAT-750.00	233
WAT-755.00	233
WAX-100.00	24
WAX-120.00	24
WAX-205.00	52
WAX-206.00	52
WAX-207.01 - .06	52
WAX-253.01	53
WAX-253.03	53

A

- Abrasives 167-168
 Accessory Kit, Flex Shaft 34
 Accessories Block 48
 Acids, Gold Testing 208
 Adalox Abrasives 167
 Adapter Mandrels/Chuck 171
 Adhesives 22, 98-99
 Agate Burnishers 74
 Airflex Wheels 168
 Alcohol Lamps 202
 Aluminum Ring Stick 92
 Aluminum Solder 207
 Annealing Pan 203
 Anti-Tarnish Strips & Bags 127
 Anti-Static Brush 221
 Anti-Static Cloth 173
 Anti-Static Mats 226
 Anvils 29
 Applicators, Oil 233
 Appraisal Certificates 77
 Apron 35
 Aquil Flux 205
 Arkansas Stones 37, 208
 Arm Rest 35
 Artistic Wire 18-19
 Attack Solvent 99
 Awls, Beading 9
- B**
- Bags, Anti-Tarnish 127
 Bags, Plastic 127
 Bags, Tool 125
 Ballpeen Hammers 100
 Baskets, Cleaning 60-61
 Batteries 222
 Battery Change Kits 222
 Battery Clamp/Screw Assortments 222
 Battery Saver 221
 Battery Testers 221
 Bausch & Lomb Magnifiers 116, 120
 Bead Boards 12
 Bead Cord 16-17
 Bead Cord Shears 6-7, 160
 Bead Crimping Pliers 2, 13
 Bead Drilling Vise 13
 Bead EZ Spinner 15
 Bead Holder 11, 13
 Bead Knotter 9
 Bead Mats 12
 Bead Nippers 6, 160
 Bead Organizers 23-27, 123-125
 Bead Reamer, Motorized 5, 69
 Bead Reamers 5, 69
 Bead Scoop 23
 Bead Shakers 23
 Bead Shovels 23
 Bead Stringing Books 180-181
 Bead Stringing Supplies 2-27
 Bead Tips 14
 Beadalon Wire 21
 Beader's Delight Pliers 9, 148
 Beader's Workstation 27
 Beading Awls 9
 Beading Kits 3
 Beading Needles 15
 Beading Pliers 6-11, 13
 Beading Tools/Plates 73
- Beading Tool Handle 73
 Beading Trays 12, 23-26
 Beading Tweezers 9, 11, 216, 220
 Beading Wire 18-22
 Beads, Crimp 14
 Beaker Holder 61
 Beeswax 24
 Bench Accessories 31-37
 Bench Anvils 28-29
 Bench Apron 28
 Bench Blocks 29, 109
 Bench Brushes 39
 Bench Filing Block 29
 Bench Knives 104, 227
 Bench Organizers 27-28
 Bench Pin and Anvil 28
 Bench Pin in Holder 28
 Bench Pin, V-Slot with Clamp 28
 Bench Pins 28
 Bench Sawwise 30
 Bench Stones 37
 Bench Tool Holder 27-28
 Bench Vises 30
 Benchmate 96
 Bending Pliers 143-148
 Bezel Blocks and Punches 111
 Bezel Mandrels 113
 Bezel Pusher 76
 Bezel Rollers 76
 Bezel Wire 238
 Blade Remover 103
 Blades, Knife 103
 Blades, Saw 187-188
 Blades, Scalpel 103
 Blades, Screwdriver 191-193
 Blocks, Bezel 111
 Blocks, Charcoal 206
 Blocks, Dapping 109-111
 Blocks, Engraving 97
 Blocks, Forming 109
 Block, Rubber 29
 Blowers 232
 Blue Magic Polishing Compound 170
 Blue Sanding Discs 168
 Boards, Beading 12
 Boards, Soldering 206
 Bobbing Compound 170
 Bobs, Felt 40
 Bone Handle Brush 39
 Books (see Publications) 180-182
 Bottle, Bead 23
 Bottle, Flux 204
 Bottles, Plastic 177
 Bow Closing/Opening Pliers 157, 237
 Boxes, Gift 127
 Boxes, Plastic 24-27, 123-125
 Boxes, Wood 48
 Bracelet Gauge 94
 Bracelet Holder 33
 Bracelet Holders, Watch 231
 Bracelet Mandrels 112
 Bracelet Pin Removers 156, 228-229
 Brass Gauges 91
 Brass Hammers 100, 102
 Brilliant Cloths 174
 Broaches 233
 Brushes 38-40
 Buffing Cloths 173-174
 Buffing Compounds 170
- Bufs 40-41
 Bur Accessories 48, 126
 Burner, Micro Flame 202
 Burnishers 74
 Burnishing Compound, liquid 172
 Burs 42-47
 Burs, Diamond 66-67
 Burs, High Speed Steel 44-45
 Burs, Inside Ring 46, 83
 Burs, Wax 47
 Butane Torch 202
- C**
- Calipers 89-91
 Calibration Weights 190
 Canvas Totes 125
 Carat Scales 189-190
 Carbide Scribes 75
 Cartridge Roll Mandrels 166
 Cartridge Rolls 166
 Carvers, Metal Clay 175
 Carvers, Wax 49-51
 Carving Files 49
 Carving Points 66-67
 Carving Wax 53-54
 Case Closing Pliers 156
 Case Holders 231
 Case Openers/Closers 223-227
 Case Opening Knives 104, 227
 Case Press 223-224
 Case Tools 223-227, 231
 Case Wrenches 225-226
 Casting Crucibles 56
 Casting Formula 56
 Casting Torch 199
 Cement, Crystal 98, 232
 Cement, Jewelers 22, 98
 Center Punch 109
 Ceramic Crucibles 56
 Ceramic Melting Dishes 56
 Ceramic Ring Stand 203
 Ceramic Soldering Boards 206
 Chains, Loupe 120
 Chamois Buff Stick 166
 Champion Cup Burs 47
 Charcoal Blocks 206
 Chasing Hammers 100
 Check Valves 200
 Chucks, Adapter 171
 Circle Cutters 111
 Clamps 13, 33
 Clamps, Ring 184-185
 Clay Stamps 178-179
 Cleaner, File 86
 Cleaner, Hand 64
 Cleaner, Jewelry 62-65
 Cleaner Steel Shot 172
 Cleaning Accessories 59-61
 Cleaning Baskets 60-61
 Cleaning Concentrates 62-63
 Cleaning Racks 59
 Cleaning Swabs 65
 Clip-on Magnifiers 116
 Clip Spring Removing Plier 156
 Clock Oil and Oiler 233
 Clock/Watch Repair Tools 221-237
 Cloths, Polishing 173-174
 Coil Maker 4
 Coiling Pliers 146-148
- Color Shapers 175
 Compartment Trays 24-26, 123-125
 Compound Cutters 162-163
 Compounds, Buffing 170
 Compounds, Cutting and Polishing 170
 Coolguard 205
 Copper Shapes 107, 238
 Copper Sheet 238
 Copper Tongs 218
 Cord, Bead 16-17
 Cord, Leather 15
 Core Drills, Diamond 81
 Cotton Gloves 36
 Crimp Beads 14
 Crimp Covers 14
 Crimpers 2, 149
 Crucible Holders 57
 Crucibles 56
 Crucibles, Graphite 56
 Crystal Bright 232
 Crystal Cement/Adhesive 22, 98, 232
 Crystal Presses 223-224
 Crystal Remover/Insertor 232
 Cup, Soldering 203
 Cut Lube 44, 80
 Cut-Off Wheels 167
 Cutter, Ring 155, 183
 Cutter, Tissue 128
 Cutter, Tube 31
 Cutters and Pliers 129-164
 Cutters, Disc 111
 Cutters, Xuron 159
 Cutting Broaches 233
 Cutting Compounds 170
 Cutting Mats 103
- D**
- Dapping Tools 109-111
 Darkfield Diamond View 115
 Degree Gauges 95
 Demagnetizer 234
 Design Blocks 178-179
 Design Stamps 106
 Detailer, Wax 5
 Dial Calipers 89
 Diamond Bead Reamers 5, 69
 Diamond Burs 66-67
 Diamond Carving Points 66-67
 Diamond Cleaning Cloth 173-174
 Diamond Detective 210
 Diamond Discs 67
 Diamond Drills 81
 Diamond Files 68, 87
 Diamond Flywheels 69
 Diamond Grading Light 115
 Diamond Handling Supplies
 Diamond Seller 77
 Display Rings 78
 Gauges 88
 Loupes 118-120
 Paper 72
 Paper Weight 72
 Parcel Box 72
 Shovels 70
 Sieves 70
 Sort Pads 77
 Trays 70
 Wallets 72
 Washing Cup 77

Diamond Instruments	66-69	Final Touch	76	Hand Files	83	
Diamond Loupes	118-120	Findings	14	Hand Piece and Accessories	34	
Diamond Points	66-67	Fine Silver Wire	238	Hand Piece Holders	34	
Diamond Power Hone	97	Finger Gauges	93	Hand Protectant- PR-88	64	
Diamond Sawblades	68, 187	Finger Guards	36	Hand Vise	30-31	
Diamond Scales	189-190	Finger Pro	36	Handles	73	
Diamond Scribe	75	Firescoff	205	Handles, File	84	
Diamond Setter's Helper	76	Fixturing Compound	37	Handles, Knife	103	
Diamond/Stone Gauges	88-90	Flashback Arrestors	200	Handy Block	48, 126	
Diamond/Stone Shovels	70	Flask Tongs	57	Handy Flux	205	
Diamond Testers	210	Flexshaft	34	Hanger, Flex-Shaft	34	
Diamond Tweezers	214-215	Flex-Shaft Accessory Kit	34	Head and Shank Tweezers	218	
Diamond View	115	Flex-Shaft Hangers	34	Headband Magnifiers	116-117, 236	
Diamond Wheels	67	Flux Bottle	204	Heat Shield	205	
DiamondNite	210	Flux Brush	40, 204	Heetrix	203	
Digital Calipers	90	Flux, Soldering	205	Hemostats	33	
Disc Cutters	111	Flywheels, Diamond	69	Hex Anvil	29	
Discs, Diamond	67	Folding Magnifier	114	High Speed Diamond Points	67	
Discs, Sanding	167-168	Forming Block	109	High Speed Steel Burs	44-45	
Discs, Separating	167	Frames, Saw	186-187	High Speed Twist Drills	79-80	
Dispenser, Flux	204	Freeman Wax	54-55	Holder, Bead	13	
Display	127-128	French Wire	14	Holder, Envelope	127	
Display Pins	128	G			Holder, Flexshaft	34
Display Rings	78	Gas Savers	200	Holders, Tube Cutting	31	
Disposable Latex Gloves	36	Gauges	88-95	Holders, Bracelet	33	
Dividers	95	Bracelet	94	Holders, Bur	48, 126	
Dormer Twist Drills	79	Brass	91	Holders, Case	231	
Drain Trap	36	Degree	95	Holders, Crucible	57	
Drawplates	10, 105	Diamond/Stone	88-90	Holders, Miniature Accessories	126	
Drawtongs	105	Finger	93	Holders, Parts	60-61	
Drill Stand	80	Gem Estimator	88	Holders, Ring	171, 203	
Drills	79-81	Jo-Di	95	Holder, Sawblade	122, 188	
Dumont Tweezers	211-212, 214	Pearl	88	Holders, Tool	27-28, 122, 125-126	
Dust Blowers	232	Pocket	88	Holders, Torch	201	
Dust Collector/Polisher	171	Ring	92-93	Holders, Universal	33	
E			Sliding	Holders, Watch	231	
E6000	22	Wire	89-91	Hole Punch	108, 155	
Easy Ear Wire	15	Gem Holders	78, 128	Horn Anvils	29	
Econoflex Wire	20	Gem Holding Rings	78	Hose Crimps	198	
Elastic Cord	17	Gem Setting Pliers	153	Hot Pot	37	
Emery Sticks	166	Gem Trays	70	I		
End Cord Fasteners	14	Gemlight	115	Ideal-Tek Tweezers	213	
English Beading Needles	15	Gentec Torches & Accessories	197-200	Indexing Mandrel	92	
Engraving Blocks	97	Glasgow Washout Brushes	39	Ingot Mold	57	
Envelopes, Appraisal	77	Glass Cleaner	64	Injection Wax	54	
Envelopes, Repair	127	Glasses, Safety	35	Injectors, Wax	52	
Epoxy	98-99	Gloves	36	Inside Ring Burs	46, 83	
Eurolustre	170	Glues	22, 98-99	Inside Ring Holder	96-97, 184	
EuroSonic Cleaner Concentrate	63	Gold Beading Wire	21	Inspection Light	114-115	
Eye Loupes	118-120	Gold Polishers	169	Ionic Cleaners	62	
F			Gold Solder	IonShine	62	
Felt Buffs	40	Gold Testers	208-209	IonSonic	62	
Fiberglass Brushes	40	Gold Testing Needles/Stones	208	J		
File Cleaner	86	Grading Light	115, 209	Jett Sett	37	
File Handles	84	Graphite Crucibles	56	Jeweler's Cleaning Kit	65	
File Organizer	87, 126	Graver Handles	84	Jewelry Boxes	127	
Files	49, 68, 82-87	Grease, Silicone	233	Jewelry Cleaners	62-65	
Diamond	68	Griffin Bead Cord	16	Jewelry Display Pins	128	
Hand	83, 86	GRS Products	96-97	Jewelry Rubber	58	
Key	86	Guards, Finger	36	Jewelry Shield	24, 128	
Needle	82, 85	Gum Arabic	22, 98	Jewelry Wire	18-22	
Pocket	85	H			Jo-Di Gauge	95
Riffler	86	Hammers	100-102	Jump Ring Maker	4	
Rotary	83	Hand Brush	39	Jump Ring Opener/Closer	4, 150	
Wax	86	Hand Cleaners	64	Jump Ring Plier	10, 150	
Wax Carving	49	Hand Drill	80			

- Snap-On 167
 Split 166
 Wax 49, 112
 Wood 112
 Marking Scribes 75
 Martini Holders 76
 Mat, Anti-Static 226
 Mat, Non-Stick 176
 Mats, Beading 12
 Mats, Cutting 103
 Max Wax Pens 51
 Media, Tumbling 172
 Melting Dish 56
 Melting Dish Holder 57
 Melting Tips 198-199
 Memory Wire 22
 Memory Wire Cutters 7
 Metal Clay Design Blocks 178-179
 Metal Clay Tools 175-177
 Metal Cutting Shears 195-196
 Metal Former 96
 Metal Corrugator 113
 Metal-Hub Brushes 38
 Metal Punch 108, 155
 Micro Cable 22
 Micro Flame Burner 202
 Micro-Therm Torch 202
 Microscopes 121
 Millgrain Tools 77
 Mills, Rolling 105
 Mini Brushes 38
 Miniature Mandrels 166-167
 Mirrors 128
 Miter Cutting Vise 31
 Mitre Saw/Set 187
 Mizar Testers 210
 Moissanite Tester 210
 Mold, Reversible Ingot 57
 Mold Cutting Knives 103
 Mold Frame 57
 Mold Opening Pliers 157
 Mold Release Spray 58
 Money Tester 208
 Motor Stand 34
 Motorized Bead Reamer 5, 69
 Motorized Handpiece/Kit 34
 Movement Holders, Watch 231
 MultiMandrel Set 112
 Muslin Buffs 41
- N**
- Necklace Mandrel 113
 Needle Files 68, 82, 85, 87
 Needle Holder 15
 Needles, Beading 15
 Needles, Gold Test 208
 Niobium Soldering Pick 204
 Nippers and Pliers 129-164
 Nucast 56
 Nut Drivers 194
 Nylon Bead Cord 16
 Nylon Cleaning Baskets 61
 Nylon Hammers 101
 Nylon Jaw Pliers 11, 145, 147
- O**
- Oiler, Pocket 233
 Openers, Case 225-227
- Opener, Prong 75
 Optiscope 121
 Optisight 117
 Optivisors 117, 236
 Organizers 23-27, 87, 122-127
- P**
- Paper Cutter 128
 Paper, Diamond 72
 Paper, Watch 72, 232
 Parallel Action Pliers 158
 Parcel Paper Box 72
 Parcel Papers 72
 Parts Holding Baskets 60-61
 Parts Trays 232
 Paste Flux 205
 Pattern Rollers 175
 Pavetron 69
 Pearl Tweezers 11, 216
 Pearl Vise 31
 Pen Platers 165
 Pen Plating Tips 165
 Phillips Screwdrivers 193-194
 Pickle Pot 202
 Pickling Compound 63, 202
 Picks 50
 Picks, Soldering 204
 Pin Holders 169
 Pin Pusher/Removers 229
 Pin Vises 32
 Pin, Jewelry Display 128
 Plastic Bags 127
 Plastic Mallets 101
 Plastic Ring Sticks 92
 Plastic Tweezer 220, 235
 Plastistat 33
 Plated Wire 21
 Plating Pens 165
 Platinum Polishers 168
 Platinum Polishing Compound 170
 Platinum Tripoli 170
 Plier and Tool Racks 122
 Pliers and Cutters 129-164
 2K Ecco 138
 Band Notching 156
 Bead Crimping 2, 13, 149
 Bead Knotting 9
 Beading 6-11, 13
 Bending 143-148
 Bow Opening/Closing 157, 237
 Carbide Cutters 161
 Case Closing 156, 237
 Coil Cutting 154
 Ergonomic 142
 Euronomic 2K 133
 Eurotech Series 139
 Forming 143-148
 Glitter-Line 136
 Hole Punching 108, 155
 Jump Ring 10, 150
 Lapjoint, German 135
 Lindstrom 129-131, 163
 Looping 8, 143, 146-148
 Micro Mini Series 142
 Mini Pliers 141
 Mirage Series 138
 Mold Opening 157
 Nylon Jaw 11, 145, 147
 Parallel Action 158
- Pin Removing 156
 Pocket Pliers 141
 Prong Opening/Closing 152-153
 Prong Cutters 159
 Relentless/German 132, 135
 Reverse 133
 Ring Cutting 155
 Ring Holding 145, 151
 Rosary 148
 Santa Fe Series 139
 Sonora Series 137
 Slip Joint 164
 Split Ring 10, 150
 Sprue Cutters 162-163
 Stone-Setting 152-153
 Teal Slimline 136
 Tube Holding/Cutting 31, 154
 Ultra Ergo 137
 Utility 164
 Value Series 140
 Watch 156-157
 Wire Twisting 13, 154
 Wire Wrapping 8, 145-147
 Wolf 8, 147
 Wrap 'n' Tap 146
 Xuron 159
 Zig Zag 153
- PMC Mandrels 112, 176
 PMC Tools 175-179
 Pocket Case Wrench 226
 Pocket Drill Sets 80
 Pocket File Sets 85
 Pocket Knife 104
 Pocket Oiler 233
 Pocket Pliers 141
 Pocket Scales 189-190
 Pocket Screwdrivers 193
 Pocket Stones 37
 Pocket Watch Keys 233
 Polisher/Dust Collector 171
 Polishers, Gold 169
 Polishers, Platinum 168
 Polishers, Silicone 168-169
 Polishing Cloths 173-174
 Polishing Compounds 64, 170
 Polishing Mandrels 171
 Polishing Pads 64
 Polishing Pins 169
 Polishing Wheels 167-169
 Pouches, Tool 87, 125-126
 Powerbrite 63
 Power Hone 97
 Power Max Cutters 163
 Power Ring Cutter 155
 Precious Metal Clay Tools 175-179
 Presidium Gauges 89-90
 Presidium Scales 190
 Presidium Testers 210
 Prong Openers 75
 Prong Pusher 76
 Protective Glasses 35
 Protective Tape 36
 Publications 180-182
 "101 Bench Tips" 182
 "Advanced Beadwork" 181
 "Basic Yemenite Filigree" (DVD) 182
 "Bead Stringing Instruction Booklet" 181
 "Complete Guide to Making Wire Jewelry" 181
 "Creative Wire Jewelry" 181
 "Gems In Myth Legend & Lore" 182
- "Holiday Moods in Wire" 180
 "How To Be A Jewelry Detective" 182
 "Inventive Metal Clay" 180
 "Jeweler's Resource Book" 182
 "Keum-Boo on Silver" 180
 "Lost Wax Casting" 182
 "Making Bead and Wire Jewelry" 180
 "Metal Clay Beyond the Basics" 180
 "Metal Clay for Beaders" 180
 "Metal Clay Magic" 180
 "Moods in Wire" 180
 "Professional Ring Repair" 182
 "Step-by-Step Bead Stringing" 181
 "The Best Little Beading Book" 181
 "The Beading Answer Book" 181
 "The Complete Metalsmith" 182
 "Wonderful, Wearable Wire" 180
 "You Made It... Now Sell It" 181
- Punch, Leather 108, 155
 Punches, Dapping 110-111
 Punches/Stamps 106-107
 Pusher, Bezel 76
 Pusher, Prong 76
- Q**
- Quasar Light 117
 QuickCooler 4
 QuikBrite 64
- R**
- Racks, Cleaning 59
 Racks, Pliers and Tool 122
 Rawhide Mallets 102
 Reamers 5, 69, 233
 Rectifiers 165
 Regulators 198-199
 Rehydration Bottle 177
 Repair Envelopes 127
 Reverse Pliers 133
 Reversible Blade Screwdrivers 192
 Reversible Ingot Mold 57
 Revolving Trays 25-26, 123-124, 126
 Rhinestone Applicator 13
 Rhodium Pen Platers 165
 Riffler Files 86
 Ring Clamps 184-185
 Ring Cutting Pliers 155
 Ring Gauges 92-93
 Ring Holders 203
 Ring Holding Pliers 145, 151
 Ring Mandrels 112-113
 Ring Size Cutter 183
 Ring Sizers 92-93
 Ring Sticks 92
 Ring Stretchers/Reducers 183
 Riveting Hammers 100
 Roller, Bezel 76
 Rolling Mill 105
 Rosary Pliers 148
 Rotary Burnishers 74
 Rotary Files 83
 Rotary Tumblers 172
 Rotating Organizers 24-26, 123-124, 126
 Rouge 170
 Rouge Cloths 174
 Rubber Blocks 29
 Rubber, Jewelry 58
 Ruby Stone Abrasives 168
 Ruler 91

S

- Safety Blade Remover 103
 Safety Glasses 35
 Safety Tape 36
 Sanding Discs 167-168
 Sanding Mandrels 166
 Sanding Pads 174
 Sanding Sticks 166
 Satin Finish Buffs 41
 Saw, Mitre 187
 Saw Vise 30
 Sawblade Holder 122, 188
 Sawblades 187-188
 Sawblades, Diamond 68, 187
 Sawframes 186-187
 Scale Weights 190
 Scales 189-190
 Scalpel Blades/Handles 103
 Scissors 6, 195-196
 Scrapers 74
 Scratch Brushes 40
 Screw Holding Tweezer 235
 Screw Mandrels 167
 Screw Removing Tools 228
 Screwdriver Blades 191-193
 Screwdrivers 191-194
 Screwdriver Stand 193
 Screwplate 233
 Scribes 75
 Scrubs 64
 Seed Bead Bottles 23, 123
 Seed Bead Spinner 15
 Selyt Cloths 173-174
 Separating Discs 167
 Setter's Helper 76
 Setting Tools 74-76
 Shapers, Metal Clay 175
 Sharpening Stones 37
 Shears, Bead Cord 6-7, 160
 Shear, Watch Band 234
 Shears 195-196
 Sheet Solder 207
 Shelfmate 27
 Shinebrite 172
 Shop Supplies 35-36
 Shot Cleaner 172
 Shovels, Bead 23
 Shovels, Diamond/Stone 70
 Sidecutters 158-163
 Sieves, Diamond 70
 Silicone Grease 233
 Silicone Polishers 168-169
 Silicone Rubber 58
 Silk Alike Bead Cord 17
 Silk Bead Cord 16
 Silver Beading Wire 20-21
 Silver Bearing Solder 207
 Silver Polishing Cloth 174
 Silver Sheet 238
 Silver Solder 207
 Silver Wire 19, 21, 238
 Sizers, Ring 92-93
 Slick Lube 37
 Sliding Gauges 89-91
 Small Torch 197-198
 Smartvise 30
 Snap-On Mandrel 167
 Snips, Metal 195-196
- Soft Flex Wire 20
 Soft Touch Wire 20
 Softshine Cloth 173
 Solder 207
 Solder Cutting Pliers 157
 Soldering Boards 206
 Soldering Cup 203
 Soldering Flux 205
 Soldering Glasses 35
 Soldering Iron 51
 Soldering Pans 203
 Soldering Pastes 207
 Soldering Picks 204
 Soldering Tools/Supplies 197-207
 Solder Cutting Pliers 157
 Third Hands 203
 Torches 197-199, 202
 Tripods 202
 Soldering Tweezers 217-219
 Solderite Boards 206
 Solutions, Cleaning 62-64
 Solvent, Glue 99
 Sorting Pads 77
 Sorting Trays 70, 124
 Sparex 202
 Sparklemaster 62
 Spatulas, Wax 49-51
 Speckgrabbers 65
 Spectacle Loupes 116
 Spindles, Tapered 171
 Spiral Hand Drill 80
 Spiral Saw Blades 187
 Split Ring Plier 10, 150
 Split Ring Tweezer 10, 220
 Spring Bar Gauge 91
 Spring Bar Tools 230
 Sprue Base Holder 57
 Sprue Cutters 162-163
 Sprue Wax 55
 Squares 95
 Squizzers 6, 196
 Stackable Round Trays 24, 26, 123
 Stamp Stand 107
 Stamps, Decorative and Karat 106-107
 Stamps, Metal Clay 178-179
 Static Wisks 39
 Steam Tweezers 60, 220
 Steamstats 60
 Steel Burnishers 74
 Steel Drawplates 105
 Steel Scribes 75
 Steel Shot 172
 Stepped Mandrels 112
 Sterling Silver Wire 21, 238
 Stone Abrasives 168
 Stone Gauges 88-91
 Stone Holders 78, 97
 Stone Papers 9, 11, 216, 220
 Stone Paper Wallets 72
 Stone Setting Pliers 152-153
 Stone Setting Tools 73-76
 Stone Shovels 70
 Stone, Gold Test 208
 StonePerfect 78
 Storage Boxes and Trays 24-27, 122-127
 Stretchers, Ring 183
 String Tags 128
 Stripper, Wire 164
 Super Glue 98-99
 Super Grip Gloves 36
- Swabs, Clean 65
 Swatch Battery Lid Opener 226

T

- Tap and Die Set 233
 Tapered Spindles 171
 Tenax Adhesive 99
 Test Acids 208
 Testers
 Battery 221
 Diamond 210
 Gold Testing 208-209
 Money 208
 Watch 221
 Texturing Hammers 102
 Texturing Tools 175-177
 Texturing Wheels 38, 41
 Third Hands 31, 203
 Thread Burner 6
 Thread Shears 196
 Tissue Cutter 128
 Titanium Soldering Picks 204
 Titanium Tweezers 214
 Tivaclean 63
 Tongs, Copper 218
 Tongs, Draw 105
 Tongs, Flask 57
 Tool Boxes 125
 Tool Organizers 27-28, 122, 125-126
 Tool Pouches 125, 126
 Torch Holder 201
 Torch Hook 201
 Torch Lighter 200
 Torch Wrench 199
 Torch, Butane 202
 Torch, Micro-Therm 202
 Torches, Soldering 197-199, 202
 Touchstones 208
 Transite Soldering Boards 206
 Trays
 Beading 12, 24-26
 Sorting 70, 124
 Storage/ Compartment 24-26, 123-126
 Triplet Loupes 118-120
 Tripods with Mesh Screen 202
 Tripoli 170
 Tube Crimps 14
 Tube Cutting Holders 31
 Tube Wringer 113
 Tuff Cord 17
 Tumblers, Rotary 172
 Tumbling Media 172
 Tungsten Drawplates 105
 Tungsten Soldering Pick 204
 Tweezers 211-220
 Allegro 215
 Beading 9, 11, 216, 220
 Diamond 214-215
 Dumont 211-212, 214
 High Precision 211
 Hi-Tech 212
 Ideal-Tek 213
 Pearl 216
 Plastic 220, 235
 Ring Holding 218
 Screw Holding 220
 Soft Touch 215
 Soldering 217-219
 Split Ring 10, 220

U

- Ultra Polish Pads 64
 Ultra-Lite Kiln 176
 Ultrasonic Cleaners 62
 Ultrasonic Cleaning Accessories 59-63
 Universal Work Holder 33, 231
 Utility Brush 40, 204
 Utility Tweezers 217-219
 UV Glue 98, 232

V

- Velvet Wand 65
 Vernier Caliper 91
 Vise, Miter 31
 Vises, Bench 30
 Vises, Hand 30
 Vise, Pearl/Bead 13
 Vises, Pin 32
 Visor Light 117

W

- Wallet, Diamond 72
 Washout Brushes 39
 Watch Analyzer 221
 Watch Band Notching Pliers 156
 Watch Band Shears 234
 Watch Band Tools
 Band Notcher 237
 Bracelet Holders 231
 Leather Punch 237
 Link Pin Removers 228-229
 Pin Pusher 229
 Repair Pliers 237
 Screw Removing Tools 228
 Shear 234
 Spring Bar Tools 230
 Watch Batteries 222
 Watch Keys 233
 Tripoli 232
 Watch Paper 237
 Watch Repair Pliers 237
 Watch Winders 221, 230
 Watchmaker's Loupes 120, 236
 Watchmakers Tools/Supplies 221-237
 Waterproof Case Wrench 224-225
 Wax 53-55
 Wax Burs 47
 Wax Carvers and Spatulas 49-51
 Wax Cutting Mandrel 49
 Wax Detailers 5, 49
 Wax Files 49, 86
 Wax Injectors 52
 Wax Mandrels 49, 112
 Wax Pens 51-52
 Wax Sawblades 187
 Wax Tools 49-52
 Weights 190
 Welding Goggles 35
 Wheel Brushes 38
 Wheels, Abrasive 167-168
 Wheels, Diamond 67
 Wheels, Polishing 167-169
 Wheels, Texturing 38, 175

Wicks, Alcohol Lamp	202
WigJig	10
Wire	238
Wire, Artistic	18-19
Wire, Beading	18-22
Wire Gauge	88
Wire Holder	15
Wire Jig	10, 15
Wire, Memory	22
Wire/Prong Cutters	159
Wire Rounder	10
Wire Solder	207
Wire Straightening Tweezer	216
Wire Stripper	164
Wire Twisting Plier	13, 154
Wire Wrapping Books	180-181
Wire Wrapping Jig	10
Wire Wrapping Kits	3
Wire Wrapping Mandrels	113
Wire Wrapping Pliers	8, 145-148
Wolf Pliers	8, 147
Wolf Wax	53
Wood Dapping Blocks	109-110
Wood Design Blocks	178-179
Wood Drawplate	10
Wood Holder for Beads	13
Wood Plier Blocks/Racks	122
Wood Mandrels	112, 171
Wood Ring Stick	92
Wood Storage Boxes	48
Work Bench Accessories	27-28
Work Holder, Universal	33, 231
Wrap 'n' Tap Pliers	8, 146
Wrench, Torch	199
Wrenches, Case	224-225
Wrenches, Mini	194

X, Y, Z

Xuron Cutters	159
Yellow Buffs	41
Zig Zag Plier	153
Zip Buffing Compound	170
Zoomscope	121